



CLM1.4 2 (4) Axis Positioning Control with Profibus

Functional Description: LAP-01VRS

	CLM1.4
Title	2 (4) Axis Positioning Control with Profibus
Type of Documentation	Functional Description
Document Typecode	DOK-CONTRL-CLM01.4LAP1-FK01-EN-P
Internal File Reference	<ul style="list-style-type: none"> Document Number: 120-0400-B331-01/EN
Purpose of Documentation	<p>This documentation describes the function of the firmware FWA-CLM1.4-LAP-01VRS-MS</p> <ul style="list-style-type: none"> for description of all functional features

Record of Revisions

Description	Release Date	Notes
DOK-CONTRL-CLM01.4LAP1-FK01-EN-P	10.01	First release

Copyright	<p>© 2001 Rexroth Indramat GmbH</p> <p>Copying this document, giving it to others and the use or communication of the contents thereof without express authority, are forbidden. Offenders are liable for the payment of damages. All rights are reserved in the event of the grant of a patent or the registration of a utility model or design (DIN 34-1).</p>
Validity	<p>The specified data is for product description purposes only and may not be deemed to be guaranteed unless expressly confirmed in the contract. All rights are reserved with respect to the content of this documentation and the availability of the product.</p>
Published by	<p>Rexroth Indramat GmbH</p> <p>INDRAMAT Hoffman Estates • 5150 Prairie Stone Parkway • Hoffman Estates, IL 60192 • USA</p> <p>Phone: 847-645-3600 • Fax: 847-645-6201</p> <p>http://www.rexroth.com/indramat</p> <p>Dept.BRC/ESG1 (VH / HK).</p>

Table of Contents

1	System Setup	1-1
1.1	The CLM at a Glance	1-1
1.2	Mechanical Data	1-2
1.3	Saving Data.....	1-3
1.4	System Overview	1-4
2	Important directions for use	2-1
2.1	Appropriate use.....	2-1
	Introduction	2-1
	Areas of use and application.....	2-2
2.2	Inappropriate use	2-2
3	Safety Instructions for Electric Drives and Controls	3-1
3.1	Introduction.....	3-1
3.2	Explanations.....	3-1
3.3	Hazards by Improper Use	3-2
3.4	General Information	3-3
3.5	Protection Against Contact with Electrical Parts.....	3-5
3.6	Protection Against Electric Shock by Protective Low Voltage (PELV).....	3-6
3.7	Protection Against Dangerous Movements.....	3-7
3.8	Protection Against Magnetic and Electromagnetic Fields During Operation and Mounting	3-9
3.9	Protection Against Contact with Hot Parts	3-10
3.10	Protection During Handling and Mounting	3-10
3.11	Battery Safety.....	3-11
3.12	Protection Against Pressurized Systems	3-11

4	Display and Operating Devices	4-1
4.1	General Information about the CTA	4-1
	CLM Display	4-2
4.2	Description of the Input Keys	4-3
	Data Entry Keys	4-3
	Control Keys	4-3
4.3	Description of the Display Modes	4-4
	Software Version / Status Diagnostics	4-5
	Material Velocity	4-6
	Variable Display	4-6
	Display: Inputs / Outputs / Marker Flags	4-7
	Counter Display	4-7
	Position Display	4-8
	Operation Data	4-10
	Program Input	4-11
	Parameter Input	4-12
5	Writing the User Program	5-1
5.1	Overview of All User Commands	5-1
5.2	General Information	5-3
5.3	Program Input	5-4
	Input via the Keypad	5-4
	Loading via the Serial Port	5-6
5.4	Starting the User Program	5-6
5.5	Stopping the User Program	5-6
5.6	Variables	5-7
	Available Variables	5-8
	System Variables	5-8
	Axis Variables	5-9
5.7	Description of Commands	5-10
	ACC - Acceleration Change	5-10
	AEA – Bit Set/Clear	5-11
	AEO – Acceleration Override Command	5-11
	AKN – Compare Bit	5-12
	AKP – Compare Byte	5-13
	APE – Byte Set/Clear	5-14
	BAC – Branch Conditional on Count	5-15
	BCE – Branch Conditional on Bit	5-16
	BIC – Branch Conditional on Bit Field Value	5-16
	BIO - Branch Conditional on Byte Compare	5-17
	BPA - Branch Conditional on Byte	5-18
	CID - Change Instruction Data	5-19
	CIO - Copy Bit Fields	5-19
	CLC - Clear Counter	5-20
	CON – Continuous Operation	5-21
	COU - Count	5-21

CPJ – Compare and Jump.....	5-23
CPL - Clear Position Error	5-23
CPS - Compare and Set a Bit	5-24
CST - Clear Subroutine Stack Level.....	5-24
CVT – Convert Variable <- -> Marker	5-25
FAK – Length Scaling Factor	5-28
FOL – Slave Axis	5-29
HOM – Home Axis	5-30
JMP – Jump Unconditional	5-31
JSR – Jump to Subroutine.....	5-31
JST – Jump, Unconditional with Immediate Stop	5-32
JTK – Program Jump in Parallel Task	5-32
MAT - Mathematics.....	5-33
NOP – No Operation.....	5-33
PBK – Stop Motion.....	5-34
POA – Positioning, Absolute.....	5-35
POI – Positioning, Incremental	5-36
PSA – Positioning Absolute with In-Position.....	5-36
PSI – Positioning Incremental with In-Position	5-37
REP – Jump on Max. Search Limit Reached	5-38
RMI – Registration Mark Interrupt.....	5-38
RSV – Restart Vector.....	5-41
RTM – Rotary Table Mode.....	5-42
RTS – Return from Subroutine	5-43
SAC - Set Abs. Position Counter	5-44
SET – Set Variable	5-45
SRM – Drive to Registration Mark	5-45
VCC – Velocity Change Command	5-47
VEO – Velocity Override Command	5-49
WAI – Wait (Time Delay)	5-52

6	Logic Task	6-1
6.1	Tabular View	6-1
6.2	Load, Save, Set and Reset Assignments	6-1
	Commands for Loading and Saving	6-1
	Set and Reset Commands.....	6-1
6.3	Logical Assignments	6-2
	AND Logic.....	6-2
	OR Logic	6-3
	XOR Logic.....	6-4
7	Functions	7-1
7.1	Operating Modes.....	7-1
7.2	Measuring Wheel Mode	7-1
7.3	Velocity Override	7-3
	Override via Analog Input	7-3
	Override via Gray-code Inputs.....	7-4
	Override via Binary-code Inputs	7-5
7.4	Vector Programming	7-6
	Manual Vector	7-6
	Interrupt Vector	7-7
7.5	Multitasking	7-8
7.6	Slave Axis.....	7-10
7.7	Mechanical Data	7-11
	Mechanical Transmission Elements	7-11
	Modulo Function	7-12
7.8	Decade Switch 'IDS01'.....	7-13
7.9	Homing.....	7-14
	General Information	7-14
	Option 1: Homing to a Home Switch.....	7-15
	Placement of the Home Switch.....	7-16
	Activation of the Home Switch	7-16
	Termination of the Homing Routine	7-16
	Option 2: Homing without a Home Switch	7-17
7.10	Position Loop Reset (Electrical Release).....	7-18
7.11	Restart.....	7-19

8	Parameters	8-1
8.1	General Information	8-3
8.2	System Parameters.....	8-5
	Ax00 Axis x Mode	8-5
	Ax01 Axis x Feed Constant.....	8-6
	Ax02 Gear	8-7
	Ax03 Axis x Minimum Travel Limit Value.....	8-7
	Ax04 Axis x Maximum Travel Limit Value.....	8-9
	Ax05 Axis x Modulo Value	8-10
	Ax06 Axis x Maximum Velocity	8-11
	Ax07 Axis x Jog Velocity.....	8-11
	Ax08 Axis x Acceleration Rate.....	8-12
	Ax09 Acceleration / Deceleration Rate	8-12
	Ax10 Jerk Constant.....	8-13
	Ax11 Axis x Kv Factor	8-14
	Ax12 Axis x Drive Sensitivity.....	8-15
	Ax13 Reserved (Free).....	8-16
	Ax14 Axis x Position Monitoring Window.....	8-16
	Ax15 Feed Angle Monitoring / Interrupt.....	8-18
	Ax16 Axis x Encoder Difference	8-19
	Ax17 Axis x Absolute Encoder Monitoring Window.....	8-19
	Ax18 Reserved (Free).....	8-19
	Ax19 Axis x Encoder Data	8-20
	Ax20 Axis x Encoder Type.....	8-20
	Ax21 Axis x Drive Direction.....	8-21
	Ax22 Axis x Absolute Encoder Home Position	8-21
	Ax23 Axis x Homing I/O	8-22
	Ax24 Axis x Homing Search Distance	8-22
	Ax25 Axis x Homing Offset	8-23
	Ax26 Reserved	8-23
	Ax27 Axis x Switching Threshold.....	8-23
	Ax28 Position Window	8-24
	Ax29 Axis x Presignaling	8-24
	Ax30 Axis x Open Feed Roll.....	8-24
	Ax31 Axis x Measuring Wheel Mode	8-25
	Ax32 Axis x Various Functions	8-25
	Ax33 Axis x Cut Inhibit.....	8-25
	Ax34 Axis x Cut Vector	8-26
8.3	General Parameters.....	8-27
	B000 Enable Axis.....	8-27
	B001 Display	8-27
	B002 RS Interface Format X6.....	8-28
	B003 RS Interface Functions X6	8-29
	B004 RS Interface Format X8.....	8-29
	B005 RS Interface Functions X8	8-29
	B006 Fieldbus Time Monitoring	8-30

B007	Fieldbus Baudrate	8-30
B008	Fieldbus Formats.....	8-31
B009	Reserved (Free)	8-31
B010	Cycle Time.....	8-32
B011	Start Program Instruction - Task 2, Task 3	8-32
B012	Start Program Instruction - Task 4, Task 5	8-33
B013	Logic Task	8-33
B014	Manual Vector	8-33
B015	Interrupt Vector.....	8-34
B016	Re-Start Vector.....	8-34
B017	Analog Input / Override.....	8-35
B018	Clear Outputs	8-36
B019	Memory Display.....	8-40
8.4	Master Encoder Parameters	8-41
C000	Master Encoder 1, Measuring Wheel Encoder Data.....	8-41
C001	Master Encoder 1, Measuring Wheel Encoder Type	8-41
C002	Master Encoder 1, Measuring Wheel Encoder Feed Constant (VK)	8-42
C003	Master Encoder 1, Measuring Wheel Offset	8-42
C004	Master Encoder 2, Measuring Wheel Encoder Data.....	8-42
C005	Master Encoder 2, Measuring Wheel Encoder Type	8-42
C006	Master Encoder 2, Measuring Wheel Encoder Feed Constant (VK)	8-42
C007	Master Encoder 2, Measuring Wheel Offset	8-42
8.5	List of CLM Parameters	8-43
8.6	Minimum and Maximum Values for Parameter Input.....	8-46

9 Interfaces 9-1

9.1	Inputs, Outputs and Marker Flags.....	9-1
	Inputs	9-2
	Outputs.....	9-7
	User-Programmable Outputs	9-11
	Flags	9-11
9.2	Serial Interfaces	9-13
	General Information	9-13
	Connecting the Interface.....	9-13
	Interface Parameters	9-16
	B002 Interface Format X6.....	9-16
	B003 Interface Functions X6.....	9-17
	Description of All Characters Used in the Data String.....	9-18
	Generating the Checksum	9-21
	Data Transmission	9-22
	Readout of Status Information	9-29

10 Command Communications	10-1
10.1 Profibus	10-1
Fieldbus Parameters	10-2
Process Data Channel	10-2
Service Data Channel	10-6
Parallel Interface	10-6
Assignment of Profibus Connector X30	10-7
Profibus LED Diagnostic	10-7
11 Diagnostic Messages	11-1
11.1 General Information about Error Identification	11-1
11.2 Error Code Numbers	11-1
11.3 Error Descriptions	11-5
General Error Messages	11-5
Error Messages for Axes 1 to 4	11-14
12 Terminal Connection Diagrams	12-1
12.1 Overview	12-1
12.2 CLM1.4 Dimensions	12-2
12.3 Power Supply and System Signals for Axes 1 and 2	12-3
12.4 System Signals for Axes 3 and 4	12-3
12.5 System Signals for Axes 1 to 4	12-4
12.6 Data Interface – Serial Channel A	12-4
12.7 RS232C/RS485 Data Interface – Serial Channel A	12-5
12.8 RS485 Data Interface – Serial Channel A	12-6
12.9 RS232C/RS485 Data Interface – Serial Channel B	12-7
12.10 Axis 1 Encoder Inputs	12-8
12.11 Axis 2 Encoder Inputs	12-9
12.12 Axis 3 Encoder Inputs	12-10
12.13 Axis 4 Encoder Inputs	12-11
12.14 Inputs – Part 1	12-12
12.15 Inputs – Part 2	12-13
12.16 Inputs – Part 3	12-14
12.17 Outputs – Part 1	12-15
12.18 Outputs – Part 2	12-16
12.19 Inputs and Outputs	12-17
12.20 Typecodes	12-18

13 Installation Notes	13-1
13.1 General Information	13-1
13.2 Instructions for Using Cooling Units in Control Cabinets	13-4
Correct Use of Cooling Units	13-4
13.3 Safety Instructions for Controls	13-6
General Information	13-6
Protection Against Contact with Electrical Parts	13-7
Protection of Safety-Separated Extra Low Voltages	13-8
Protection Against Dangerous Movements	13-8
Protection During Handling and Installation	13-9
Protection for Built-In Batteries	13-10
14 Index	14-1
15 Service & Support	15-1
15.1 Helpdesk	15-1
15.2 Service-Hotline	15-1
15.3 Internet	15-1
15.4 Vor der Kontaktaufnahme... - Before contacting us	15-1
15.5 Kundenbetreuungsstellen - Sales & Service Facilities	15-2

1 System Setup

1.1 The CLM at a Glance

The CLM is a compact, modular, 4-axis CNC control that can be combined with maintenance-free dynamic Rexroth Indramat AC Servo drives to create an efficient and economical control and drive system.

Typical applications are:

- Roll-feed Systems
- Packaging Machinery
- Thermoforming Machinery
- Linear Portals
- Robot Devices
- Bending Machinery
- Wood-processing Machinery

The efficient user program enables the CLM to execute complicated processes.

Combined with maintenance-free, dynamic Rexroth Indramat AC Servo drives, the CLM achieves:

- a noticeable increase in productivity because of improved system availability and higher roll-feed capacity.
- markedly increased quality through incremental control of position, velocity and acceleration.
- eliminating the need for an additional PLC control through many additional functions.
- ON-LINE programmability
- programming in the appropriate language, either directly from the front panel or from a PC via a serial interface.
- tailoring of drive and machine data using simple parameter input. no specialized unit is required for parameter input.
- segmentation of complex machine processes due to a user program with 3000 instructions. immediate availability of all status information about initial startup, monitoring and service support via the system display or the serial interface.
- increased system security because of continuous drive and measuring wheel encoder monitoring.
- a compact control and drive package, in combination with Rexroth Indramat drives.

1.2 Mechanical Data

- Operating Modes**
- Parameter
 - Manual
 - Automatic
- Control Characteristics:**
- 4 axes
 - units can be defined in mm, inches and degrees
 - dimensions can be programmed as incremental or absolute
 - preselection of velocity in ‰ of Vmax
 - maximum system and manual (jog) velocity programmable via parameters
 - feed velocity programmable via the user program
- Program Data:**
- 3000 instructions
 - any number of subprograms, with nesting hierarchy up to 127
 - system variables
 - 400 available variables
 - 224 marker flags
- Logic Task:**
- 1000 assignments
 - Processing speed: 1000 assignments/sec
 - Cycle time 4ms
 - System flags
 - 320 marker flags
- Interfaces:**
- parallel interface
24 permanent system inputs and 18 permanent system outputs
88 inputs and 51 outputs available (freely-programmable) in the user program
- Control Interface:**
- 4 analog inputs +/- 10 V (12-bit resolution)
 - 4 analog outputs +/- 10 V (14-bit resolution) – for controlling 4 servo drives
- Data Interface:**
- serial, RS232C or RS485
 - freely-selectable baud rate and transmission format
- Fieldbus Interface:**
- Profibus
- Measuring System Interface:**
- linear and rotary incremental encoders with a maximum sampling frequency of 1 MHz
 - synchronous absolute encoders / SSI synchronous transmission, gray-coded
- Voltage Supply:**
- Voltage: + 24 V DC; + 20 %; determined by the drive electronics, e.g. TVM, KDV, TVD

- Current Requirements:**
- approx. 450 mA – for the CLM without no encoder or accessories
 - approx. 50 mA – per incremental encoder
 - approx. 125 mA – absolute encoder
 - approx. 50 mA – for the decade switch unit (IDS01)
 - approx. 100 mA – for the Optional Expanded I/O
- Dimensions:**
- The dimensions of the CLM control correspond to the modularly built Rexroth Indramat AC controllers, e.g. TVM and TDM. Depth x Width x Height = 330 x 105 x 390 mm
- Weight:**
- The CLM control weighs approximately 13.3 lbs. (6 kg).

1.3 Saving Data

The user program is saved in buffered RAM memory on a module card (MOK19) inside the CLM.

Note: This data can be lost in the event of an error. Therefore, it is critically important to back up this data in another place outside the control. (e.g.: external computer that contains the MotionManager PC program, or as a hard copy)

Buffering occurs with the help of a battery back-up, which is continuously charged during operation and which provides power to the RAM memory when the power supply is turned off. At the factory, the battery is not charged to 100% capacity. Total charging time is approx. 40 hours and data security using a fully charged battery is 0.5 years.

During each new start-up of the control and every four hours during operation, a battery test is performed. If the battery charge not sufficient, the error "Battery is low" is displayed after turning on the power supply, and the "Error" output is not set. This error can be cleared using the Clear key. Every 10 minutes, the message "Battery is low" is displayed.

1.4 System Overview

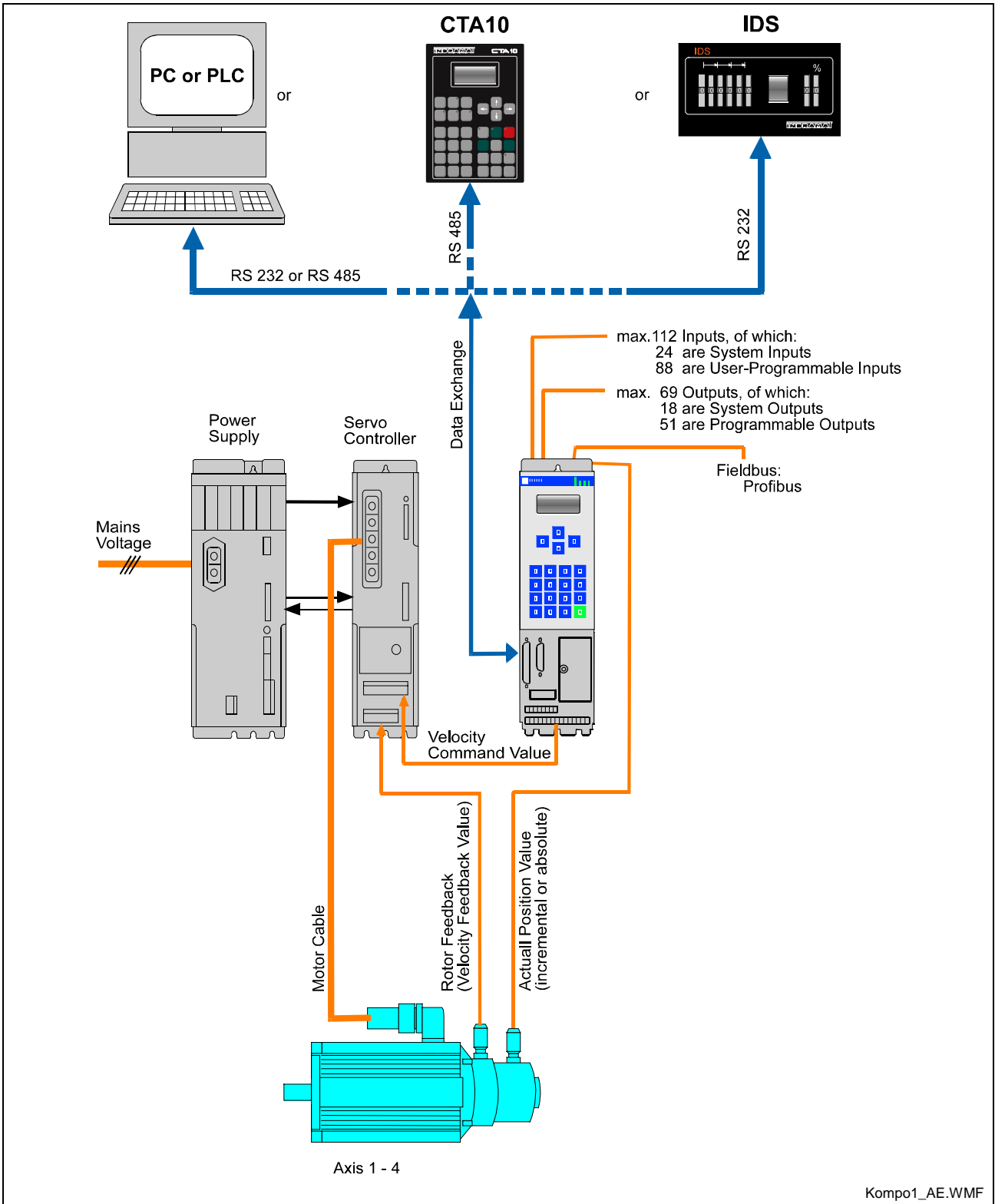

Fig. 1-1: System Overview

2 Important directions for use

2.1 Appropriate use

Introduction

Rexroth Indramat products represent state-of-the-art developments and manufacturing. They are tested prior to delivery to ensure operating safety and reliability.

The products may only be used in the manner that is defined as appropriate. If they are used in an inappropriate manner, then situations can develop that may lead to property damage or injury to personnel.

Note: Rexroth Indramat, as manufacturer, is not liable for any damages resulting from inappropriate use. In such cases, the guarantee and the right to payment of damages resulting from inappropriate use are forfeited. The user alone carries all responsibility of the risks.

Before using Rexroth Indramat products, make sure that all the prerequisites for appropriate use of the products are satisfied:

- Personnel that in any way, shape or form uses our products must first read and understand the relevant safety instructions and be familiar with appropriate use.
- If the product takes the form of hardware, then they must remain in their original state, in other words, no structural changes are permitted. It is not permitted to decompile software products or alter source codes.
- Do not mount damaged or faulty products or use them in operation.
- Make sure that the products have been installed in the manner described in the relevant documentation.

Areas of use and application

For CLM1.4-LAP Rexroth Indramat defines appropriate use as for precision motion control of to four axes.

Control and monitoring of (the) CLM1.4-LAP may require additional sensors and actors.

Note: CLM1.4-LAP may only be used with the accessories and parts specified in this document. If a component has not been specifically named, then it may not be either mounted or connected. The same applies to cables and lines.

Operation is only permitted in the specified configurations and combinations of components using the software and firmware as specified in the relevant function descriptions.

The CLM1.4-LAP and every drive controller has to be programmed before starting it up, making it possible for the motor to execute the specific functions of an application.

The CLM1.4-LAP has been developed for use in single or multiple-axis drives and control tasks.

Typical applications of CLM1.4-LAP are:

- Handling and assembly systems,
- Roll feeds
- Automatic bending machines and
- Woodworking machines

The CLM1.4-LAP may only be operated under the assembly, installation and ambient conditions as described here (temperature, system of protection, humidity, EMC requirements, etc.) and in the position specified.

2.2 Inappropriate use

Using the CLM1.4-LAP outside of the above-referenced areas of application or under operating conditions other than described in the document and the technical data specified is defined as "inappropriate use".

CLM1.4-LAP may not be used if

- they are subject to operating conditions that do not meet the above specified ambient conditions. This includes, for example, operation under water, in the case of extreme temperature fluctuations or extremely high maximum temperatures or if
- Rexroth Indramat has not specifically released them for that intended purpose. Please note the specifications outlined in the general Safety Guidelines!

3 Safety Instructions for Electric Drives and Controls

3.1 Introduction

Read these instructions before the initial startup of the equipment in order to eliminate the risk of bodily harm or material damage. Follow these safety instructions at all times.

Do not attempt to install or start up this equipment without first reading all documentation provided with the product. Read and understand these safety instructions and all user documentation of the equipment prior to working with the equipment at any time. If you do not have the user documentation for your equipment, contact your local Rexroth Indramat representative to send this documentation immediately to the person or persons responsible for the safe operation of this equipment.

If the equipment is resold, rented or transferred or passed on to others, then these safety instructions must be delivered with the equipment.



WARNING

Improper use of this equipment, failure to follow the safety instructions in this document or tampering with the product, including disabling of safety devices, may result in material damage, bodily harm, electric shock or even death!

3.2 Explanations

The safety instructions describe the following degrees of hazard seriousness in compliance with ANSI Z535. The degree of hazard seriousness informs about the consequences resulting from non-compliance with the safety instructions.

Warning symbol with signal word	Degree of hazard seriousness according to ANSI
 DANGER	Death or severe bodily harm will occur.
 WARNING	Death or severe bodily harm may occur.
 CAUTION	Bodily harm or material damage may occur.

Fig. 3-1: Hazard classification (according to ANSI Z535)

3.3 Hazards by Improper Use



DANGER

**High voltage and high discharge current!
Danger to life or severe bodily harm by electric shock!**



DANGER

Dangerous movements! Danger to life, severe bodily harm or material damage by unintentional motor movements!



WARNING

High electrical voltage due to wrong connections! Danger to life or bodily harm by electric shock!



WARNING

Health hazard for persons with heart pacemakers, metal implants and hearing aids in proximity to electrical equipment!



CAUTION

Surface of machine housing could be extremely hot! Danger of injury! Danger of burns!



CAUTION

Risk of injury due to improper handling! Bodily harm caused by crushing, shearing, cutting and mechanical shock or incorrect handling of pressurized systems!



CAUTION

Risk of injury due to incorrect handling of batteries!

3.4 General Information

- Rexroth Indramat GmbH is not liable for damages resulting from failure to observe the warnings provided in this documentation.
- Read the operating, maintenance and safety instructions in your language before starting up the machine. If you find that you cannot completely understand the documentation for your product, please ask your supplier to clarify.
- Proper and correct transport, storage, assembly and installation as well as care in operation and maintenance are prerequisites for optimal and safe operation of this equipment.
- Only persons who are trained and qualified for the use and operation of the equipment may work on this equipment or within its proximity.
 - The persons are qualified if they have sufficient knowledge of the assembly, installation and operation of the equipment as well as an understanding of all warnings and precautionary measures noted in these instructions.
 - Furthermore, they must be trained, instructed and qualified to switch electrical circuits and equipment on and off in accordance with technical safety regulations, to ground them and to mark them according to the requirements of safe work practices. They must have adequate safety equipment and be trained in first aid.
- Only use spare parts and accessories approved by the manufacturer.
- Follow all safety regulations and requirements for the specific application as practiced in the country of use.
- The equipment is designed for installation in industrial machinery.
- The ambient conditions given in the product documentation must be observed.
- Use only safety features and applications that are clearly and explicitly approved in the Project Planning Manual.

For example, the following areas of use are not permitted: construction cranes, elevators used for people or freight, devices and vehicles to transport people, medical applications, refinery plants, transport of hazardous goods, nuclear applications, applications sensitive to high frequency, mining, food processing, control of protection equipment (also in a machine).
- The information given in this documentation with regard to the use of the delivered components contains only examples of applications and suggestions.

The machine and installation manufacturer must

 - make sure that the delivered components are suited for his individual application and check the information given in this documentation with regard to the use of the components,
 - make sure that his application complies with the applicable safety regulations and standards and carry out the required measures, modifications and complements.
- Startup of the delivered components is only permitted once it is sure that the machine or installation in which they are installed complies with the national regulations, safety specifications and standards of the application.

- Operation is only permitted if the national EMC regulations for the application are met.
The instructions for installation in accordance with EMC requirements can be found in the documentation "EMC in Drive and Control Systems".
The machine or installation manufacturer is responsible for compliance with the limiting values as prescribed in the national regulations.
- Technical data, connections and operational conditions are specified in the product documentation and must be followed at all times.

3.5 Protection Against Contact with Electrical Parts

Note: This section refers to equipment and drive components with voltages above 50 Volts.

Touching live parts with voltages of 50 Volts and more with bare hands or conductive tools or touching ungrounded housings can be dangerous and cause electric shock. In order to operate electrical equipment, certain parts must unavoidably have dangerous voltages applied to them.



DANGER

High electrical voltage! Danger to life, severe bodily harm by electric shock!

- ⇒ Only those trained and qualified to work with or on electrical equipment are permitted to operate, maintain or repair this equipment.
 - ⇒ Follow general construction and safety regulations when working on high voltage installations.
 - ⇒ Before switching on power the ground wire must be permanently connected to all electrical units according to the connection diagram.
 - ⇒ Do not operate electrical equipment at any time, even for brief measurements or tests, if the ground wire is not permanently connected to the points of the components provided for this purpose.
 - ⇒ Before working with electrical parts with voltage higher than 50 V, the equipment must be disconnected from the mains voltage or power supply. Make sure the equipment cannot be switched on again unintended.
 - ⇒ The following should be observed with electrical drive and filter components:
 - ⇒ Wait five (5) minutes after switching off power to allow capacitors to discharge before beginning to work. Measure the voltage on the capacitors before beginning to work to make sure that the equipment is safe to touch.
 - ⇒ Never touch the electrical connection points of a component while power is turned on.
 - ⇒ Install the covers and guards provided with the equipment properly before switching the equipment on. Prevent contact with live parts at any time.
 - ⇒ A residual-current-operated protective device (RCD) must not be used on electric drives! Indirect contact must be prevented by other means, for example, by an overcurrent protective device.
 - ⇒ Electrical components with exposed live parts and uncovered high voltage terminals must be installed in a protective housing, for example, in a control cabinet.
-

To be observed with electrical drive and filter components:



DANGER

**High electrical voltage on the housing!
High leakage current! Danger to life, danger of
injury by electric shock!**

- ⇒ Connect the electrical equipment, the housings of all electrical units and motors permanently with the safety conductor at the ground points before power is switched on. Look at the connection diagram. This is even necessary for brief tests.
- ⇒ Connect the safety conductor of the electrical equipment always permanently and firmly to the supply mains. Leakage current exceeds 3.5 mA in normal operation.
- ⇒ Use a copper conductor with at least 10 mm² cross section over its entire course for this safety conductor connection!
- ⇒ Prior to startups, even for brief tests, always connect the protective conductor or connect with ground wire. Otherwise, high voltages can occur on the housing that lead to electric shock.

3.6 Protection Against Electric Shock by Protective Low Voltage (PELV)

All connections and terminals with voltages between 0 and 50 Volts on Rexroth Indramat products are protective low voltages designed in accordance with international standards on electrical safety.



WARNING

**High electrical voltage due to wrong
connections! Danger to life, bodily harm by
electric shock!**

- ⇒ Only connect equipment, electrical components and cables of the protective low voltage type (PELV = Protective Extra Low Voltage) to all terminals and clamps with voltages of 0 to 50 Volts.
- ⇒ Only electrical circuits may be connected which are safely isolated against high voltage circuits. Safe isolation is achieved, for example, with an isolating transformer, an opto-electronic coupler or when battery-operated.

3.7 Protection Against Dangerous Movements

Dangerous movements can be caused by faulty control of the connected motors. Some common examples are:

- improper or wrong wiring of cable connections
- incorrect operation of the equipment components
- wrong input of parameters before operation
- malfunction of sensors, encoders and monitoring devices
- defective components
- software or firmware errors

Dangerous movements can occur immediately after equipment is switched on or even after an unspecified time of trouble-free operation.

The monitoring in the drive components will normally be sufficient to avoid faulty operation in the connected drives. Regarding personal safety, especially the danger of bodily injury and material damage, this alone cannot be relied upon to ensure complete safety. Until the integrated monitoring functions become effective, it must be assumed in any case that faulty drive movements will occur. The extent of faulty drive movements depends upon the type of control and the state of operation.

**DANGER****Dangerous movements! Danger to life, risk of injury, severe bodily harm or material damage!**

- ⇒ Ensure personal safety by means of qualified and tested higher-level monitoring devices or measures integrated in the installation. Unintended machine motion is possible if monitoring devices are disabled, bypassed or not activated.
 - ⇒ Pay attention to unintended machine motion or other malfunction in any mode of operation.

 - ⇒ Keep free and clear of the machine's range of motion and moving parts. Possible measures to prevent people from accidentally entering the machine's range of motion:
 - use safety fences
 - use safety guards
 - use protective coverings
 - install light curtains or light barriers
 - ⇒ Fences and coverings must be strong enough to resist maximum possible momentum, especially if there is a possibility of loose parts flying off.
 - ⇒ Mount the emergency stop switch in the immediate reach of the operator. Verify that the emergency stop works before startup. Don't operate the machine if the emergency stop is not working.
 - ⇒ Isolate the drive power connection by means of an emergency stop circuit or use a starting lockout to prevent unintentional start.
 - ⇒ Make sure that the drives are brought to a safe standstill before accessing or entering the danger zone. Safe standstill can be achieved by switching off the power supply contactor or by safe mechanical locking of moving parts.
 - ⇒ Secure vertical axes against falling or dropping after switching off the motor power by, for example:
 - mechanically securing the vertical axes
 - adding an external braking/ arrester/ clamping mechanism
 - ensuring sufficient equilibration of the vertical axes
- The standard equipment motor brake or an external brake controlled directly by the drive controller are not sufficient to guarantee personal safety!

- ⇒ Disconnect electrical power to the equipment using a master switch and secure the switch against reconnection for:
 - maintenance and repair work
 - cleaning of equipment
 - long periods of discontinued equipment use
 - ⇒ Prevent the operation of high-frequency, remote control and radio equipment near electronics circuits and supply leads. If the use of such equipment cannot be avoided, verify the system and the installation for possible malfunctions in all possible positions of normal use before initial startup. If necessary, perform a special electromagnetic compatibility (EMC) test on the installation.
-

3.8 Protection Against Magnetic and Electromagnetic Fields During Operation and Mounting

Magnetic and electromagnetic fields generated near current-carrying conductors and permanent magnets in motors represent a serious health hazard to persons with heart pacemakers, metal implants and hearing aids.



WARNING

Health hazard for persons with heart pacemakers, metal implants and hearing aids in proximity to electrical equipment!

- ⇒ Persons with heart pacemakers, hearing aids and metal implants are not permitted to enter the following areas:
 - Areas in which electrical equipment and parts are mounted, being operated or started up.
 - Areas in which parts of motors with permanent magnets are being stored, operated, repaired or mounted.
 - ⇒ If it is necessary for a person with a heart pacemaker to enter such an area, then a doctor must be consulted prior to doing so. Heart pacemakers that are already implanted or will be implanted in the future, have a considerable variation in their electrical noise immunity. Therefore there are no rules with general validity.
 - ⇒ Persons with hearing aids, metal implants or metal pieces must consult a doctor before they enter the areas described above. Otherwise, health hazards will occur.
-

3.9 Protection Against Contact with Hot Parts



CAUTION

**Housing surfaces could be extremely hot!
Danger of injury! Danger of burns!**

- ⇒ Do not touch housing surfaces near sources of heat! Danger of burns!
- ⇒ After switching the equipment off, wait at least ten (10) minutes to allow it to cool down before touching it.
- ⇒ Do not touch hot parts of the equipment, such as housings with integrated heat sinks and resistors. Danger of burns!

3.10 Protection During Handling and Mounting

Under certain conditions, incorrect handling and mounting of parts and components may cause injuries.



CAUTION

Risk of injury by incorrect handling! Bodily harm caused by crushing, shearing, cutting and mechanical shock!

- ⇒ Observe general installation and safety instructions with regard to handling and mounting.
- ⇒ Use appropriate mounting and transport equipment.
- ⇒ Take precautions to avoid pinching and crushing.
- ⇒ Use only appropriate tools. If specified by the product documentation, special tools must be used.
- ⇒ Use lifting devices and tools correctly and safely.
- ⇒ For safe protection wear appropriate protective clothing, e.g. safety glasses, safety shoes and safety gloves.
- ⇒ Never stand under suspended loads.
- ⇒ Clean up liquids from the floor immediately to prevent slipping.

3.11 Battery Safety

Batteries contain reactive chemicals in a solid housing. Inappropriate handling may result in injuries or material damage.



CAUTION

Risk of injury by incorrect handling!

- ⇒ Do not attempt to reactivate discharged batteries by heating or other methods (danger of explosion and cauterization).
- ⇒ Never charge non-chargeable batteries (danger of leakage and explosion).
- ⇒ Never throw batteries into a fire.
- ⇒ Do not dismantle batteries.
- ⇒ Do not damage electrical components installed in the equipment.

Note: Be aware of environmental protection and disposal! The batteries contained in the product should be considered as hazardous material for land, air and sea transport in the sense of the legal requirements (danger of explosion). Dispose batteries separately from other waste. Observe the legal requirements in the country of installation.

3.12 Protection Against Pressurized Systems

Certain motors and drive controllers, corresponding to the information in the respective Project Planning Manual, must be provided with pressurized media, such as compressed air, hydraulic oil, cooling fluid and cooling lubricant supplied by external systems. Incorrect handling of the supply and connections of pressurized systems can lead to injuries or accidents. In these cases, improper handling of external supply systems, supply lines or connections can cause injuries or material damage.



CAUTION

Danger of injury by incorrect handling of pressurized systems !

- ⇒ Do not attempt to disassemble, to open or to cut a pressurized system (danger of explosion).
- ⇒ Observe the operation instructions of the respective manufacturer.
- ⇒ Before disassembling pressurized systems, release pressure and drain off the fluid or gas.
- ⇒ Use suitable protective clothing (for example safety glasses, safety shoes and safety gloves)
- ⇒ Remove any fluid that has leaked out onto the floor immediately.

Note: Environmental protection and disposal! The media used in the operation of the pressurized system equipment may not be environmentally compatible. Media that are damaging the environment must be disposed separately from normal waste. Observe the legal requirements in the country of installation.

Notes

4 Display and Operating Devices

4.1 General Information about the CTA

The CTA, which has a liquid-crystal display (LCD), is located on the front panel of the CLM.

The display consists of 4 lines of 16 characters each. Below the display is a keypad with pressure-sensitive keys for data entry and manipulation of the display options.

A cursor blinks at the location where an input is to be made. The cursor automatically moves to the next position after a data key is pressed.

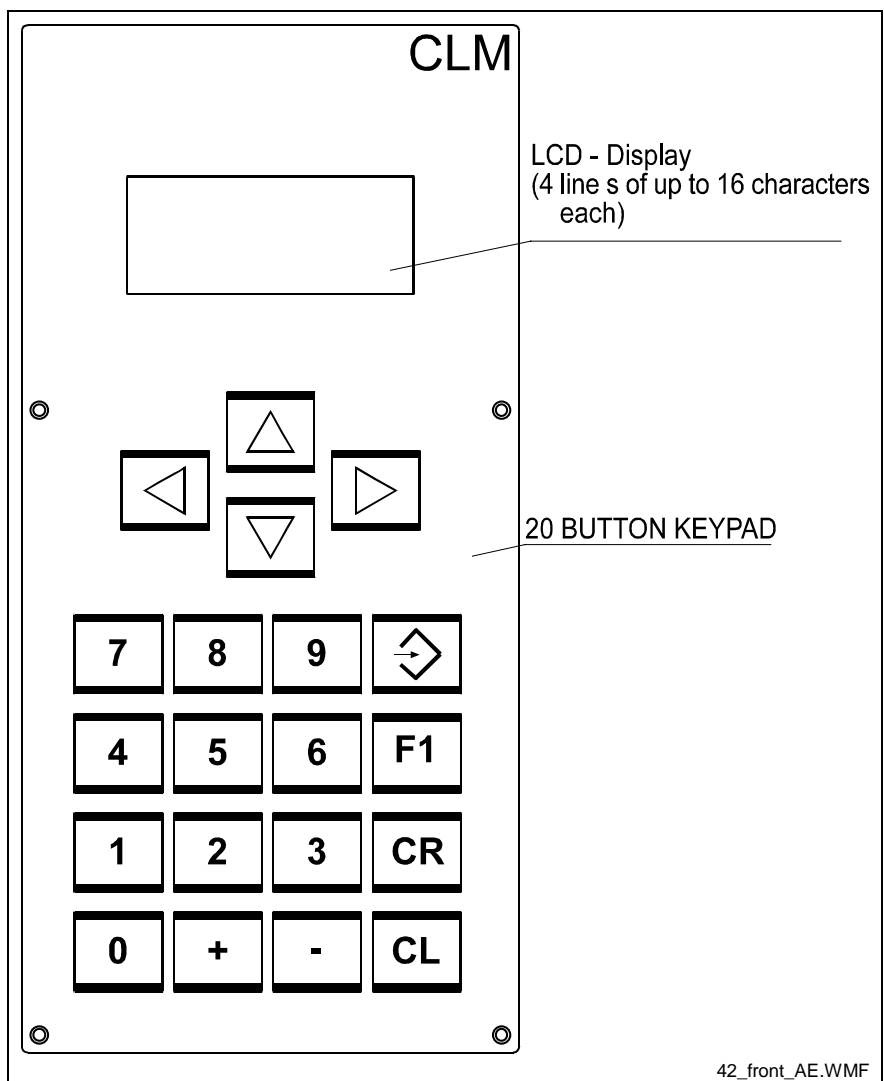

Fig. 4-1: Display / Keypad Module

CLM Display

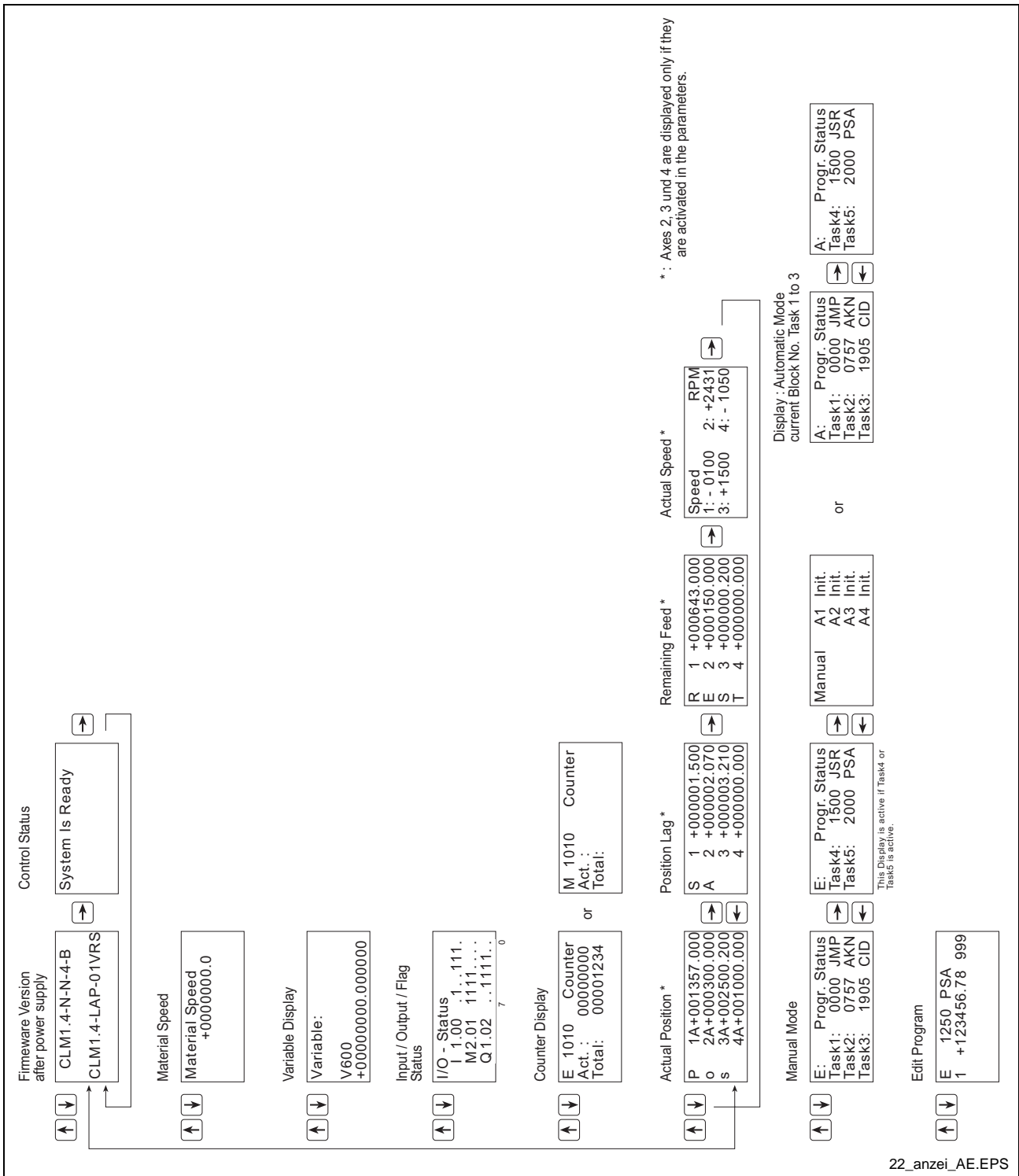
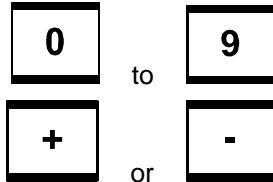

Fig. 4-2: Map of Display Screens

4.2 Description of the Input Keys

Data Entry Keys

The data entry keys allow for the input of program or parameter data and their functionality is shown depending on the type of data required.



For inputting program data, if the cursor is in the 2nd display line, these keys can be used to change the operational sign of a value (e.g. for positioning direction). If the cursor is in the 1st display line, these keys can be used to scroll up and down through the program instructions.

Control Keys



Faults can be cleared using the 'Clear' key.



Using this key, the cursor can be moved to defined positions for data input.

Program Input: Pressing the CR key twice moves the cursor from the second display line to the first line directly following the program command, and on the first digit of the program instruction number.

Parameter Input: Pressing the CR key twice moves the cursor from any position in the data field to the first position of the data field and then to the second digit of the parameter number.

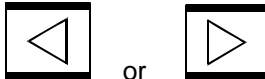

These keys move the cursor by one space to the right or left. When loading the program, the cursor can be moved within the data field (second line), depending on the internal input mask. This means that the cursor can only be moved to positions that require an input.

Refer to the description of the User Program Commands. Additional functions of this key are described.

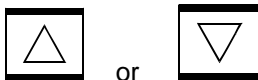

1. In the cursor's base position, these keys allow the user to switch between display modes.

2. Display Mode 'Program Input':

If the cursor is positioned after the command, the user can use these keys to scroll through the user commands.

If the cursor is positioned at a position that can contain Q,M,I or 0, the user can scroll through these characters.

If the cursor is positioned at a position that can contain a V (variable), the user can toggle between variable and constant input types.

3. Display Mode 'Parameter Input':

If the cursor is positioned on the parameter number, the user can scroll through the parameter types (B0, A1, A2, A3, A4, C0).

If the cursor is positioned at a position that can contain Q,M,I or 0, the user can scroll through these characters.



After pressing this key, the data shown on the display is transferred to the program memory or the parameter memory.

After the data is transferred, the next instruction (current instruction number +1) or the next parameter (current parameter number +1) is displayed.



Available only in Parameter mode.

4.3 Description of the Display Modes

Because of the varied information that must be displayed, the display is multi-functional. The operating mode determines the available quantity and types of display modes.

The following operating modes exist:

- Parameter
- Manual
- Automatic

Depending on the operating mode, the following displays are possible:

Operating Mode: Parameter

1. Parameter Input

Operating Mode: Manual

1. CLM Software Version / Diagnostics
2. (Material Velocity)
3. Variable Display
4. Status of the Inputs or Outputs
5. Counter
6. Position Display / Position Lag / Remaining Length / Speed
7. Task Display
8. Program Input

Operating Mode: Automatic

1. CLM Software Version / Diagnostics
2. (Material Velocity)
3. Variable Display
4. Status of the Inputs or Outputs
5. Counter
6. Position Display / Position Lag / Remaining Length / Speed
7. Task Display
8. Program Input

After turning on the control or after clearing a fault, the CLM either displays the software version or 'Parameter Input' mode is active (see Operating Mode). The display mode can be changed at any time. In order to do this, the cursor must be returned to the base position: first line, third position. This movement can be made by pressing the \rightarrow and \leftarrow keys, or, more simply, by pressing CR . Then the display mode can be changed using the \uparrow and \downarrow keys.

For some display modes, no blinking cursor is shown. In such cases, the cursor is in its base position but it is not visible.

Software Version / Status Diagnostics

In this display, the user can switch to Status Diagnostics by pressing \rightarrow or \leftarrow . The diagnostic depends on the operating mode and the status.

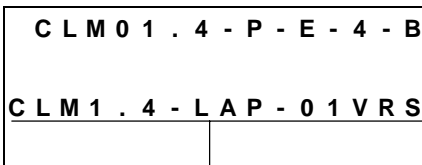

Software Description

The release version is shown in line 4 by pressing F1 .

Operating Mode: Manual



Control Status: Immediate Stop at +24V



Control Status: Immediate Stop at +0V

Operating Mode: Automatic

```
A :  N o  C y c l  S t a r t
```

Control Status:

Immediate Stop at +24V

No Start Signal (Program not running)

```
A :  S t a r t  A c t i v e
```

Control Status:

Immediate Stop at +24V

Start Signal present (Program running)

```
S t o p  A c t i v e
```

Control Status:

Immediate Stop at +0V

Material Velocity

This display is only valid in conjunction with the function 'Flying Shear Device.' The test velocity can be input.

```
M a t e r i a l  S p e e d
      + 0 0 0 0 0 0 0 . 0
```

Variable Display

The contents of a variable can be displayed. The variable number can be input directly or changed by pressing $\boxed{+}$ or $\boxed{-}$.

```
V a r i a b l e  :
V 6 0 0
+ 0 0 0 0 0 0 0 0 . 0 0 0 0 0 0
```

Display: Inputs / Outputs / Marker Flags

The bits of the selected byte are displayed. Every line allows Inputs / Outputs / Marker Flags to be displayed.

The byte address can be changed by pressing \square^+ or \square^- . Every line allows Inputs / Outputs / Marker Flags to be displayed. Using the \square^{\leftarrow} or \square^{\rightarrow} keys, you can move between lines.

I / O	-	S	t	a	t	u	s
I 1	.	0	0	.	.	1	1 . . . 1
Q 1	.	0	1	.	.	1	1 1 . . 1 1 1
M 2	.	0	2	.	.	1	1 1 . .
		Bit 7 0					

The cursor can be positioned here using the \square^{CR} key. Using the \square^{\triangle} and \square^{∇} keys, the user can invoke a different display.

Counter Display

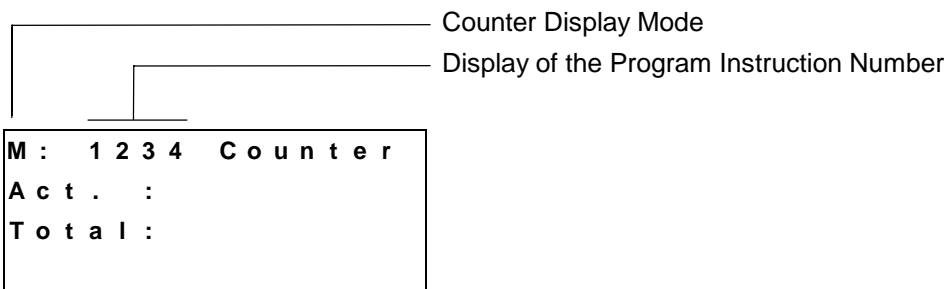



In this display mode, the current status of any programmed counter can be viewed. The desired program instruction number must be entered in the first line.

To achieve this, the cursor can be moved to the program instruction number by pressing \square^{\leftarrow} or \square^{\rightarrow} and then enter the desired number using the keys \square^0 to \square^9 . The entered program instruction number is maintained in all operating conditions, until a new number is input. If no counter is programmed in the displayed program instruction, nothing is displayed on the second, third and fourth lines.

When the cursor is in its base position, the user can leave this display mode. With the cursor in this position, the user can also scroll back or forward through program instruction numbers in increments of 1 using the \square^+ and \square^- keys.

Position Display

In this display mode, the user can display the current position by pressing  or .

Display Mode 'Length':

P	1	A	+	0	0	1	3	7	5	.	3	4	5
o	2		+	0	0	0	2	5	0	.	0	0	0
s	3		+	0	0	0	0	1	0	.	5	0	0
	4	A	+	0	0	0	5	5	5	.	1	1	0

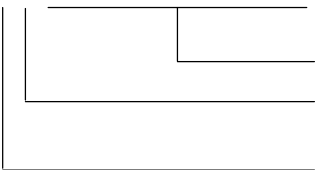

Actual position value in IUs (input units)

Travel Range: No Operation (Blank Block) = Relative
 A = Absolute

Axis Number

The travel range 'Relative' is displayed if the drive is not set to absolute while detecting a position using an incremental encoder. The actual position display can be reset to zero by pressing , so that a new relative zero point can be entered. Zeroing occurs for all axes.

The travel range 'Absolute' is displayed for the drive, while detecting a position using an incremental encoder after homing or generally when using an absolute encoder.

Display Mode 'Lag Distance':

S	1		+	0	0	0	1	0	0	.	5	0	0
A	2		+	0	0	0	2	5	0	.	5	0	0
	3		+	0	0	0	1	0	0	.	5	0	0
	4		+	0	0	0	2	0	0	.	5	0	

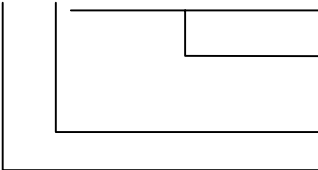

Difference between the command and actual positions (following error) in Input Units (IU).

Travel range

Axis Number

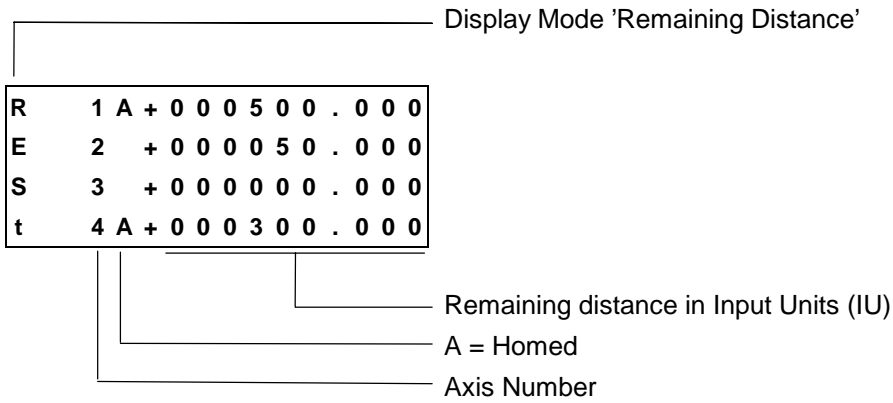

For Interrupting, Immediate Stop and Positioning Monitoring, the remaining travel distance is shown. For axes that are not programmed, no information is shown on the display.

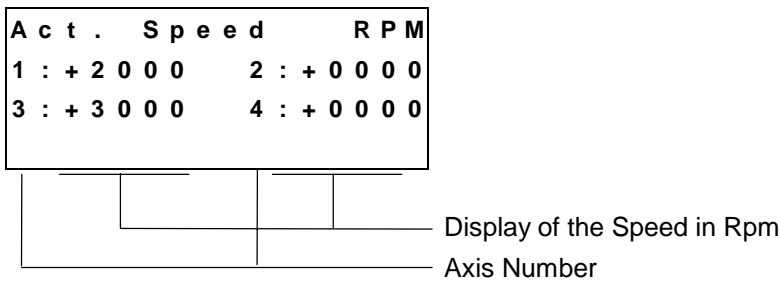

The displayed speed is a message about the last 32 cycles, in order to keep the contents of the display consistent. Speed values are rounded to the nearest whole number. For axes that are not programmed, no information is shown on the display.

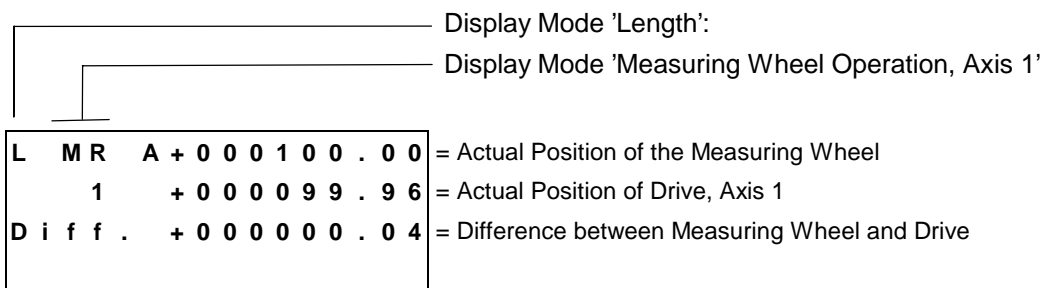



If a measuring wheel in the system is being monitored by the control, an additional display appears.

The measuring wheel position display is only active when you are in Measuring Wheel Mode. If axis 1 is not homed, the displayed position can be set to zero by pressing **CR**.

Operation Data

Automatic

In this display mode, the program instruction that is currently being processed is displayed.

The first 3 tasks (if programmed) are displayed simultaneously. If Tasks 4 and 5 are also programmed, these can be displayed by pressing  or .

The display in Automatic Mode is also valid for Manual Mode.

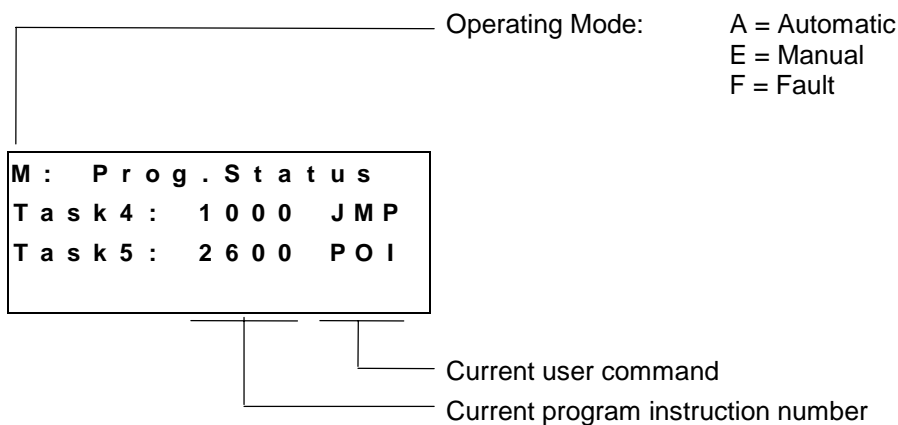
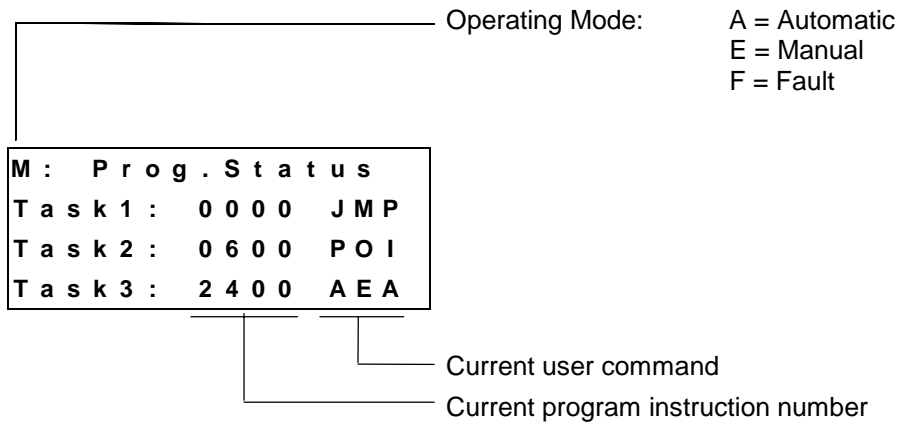

Manual

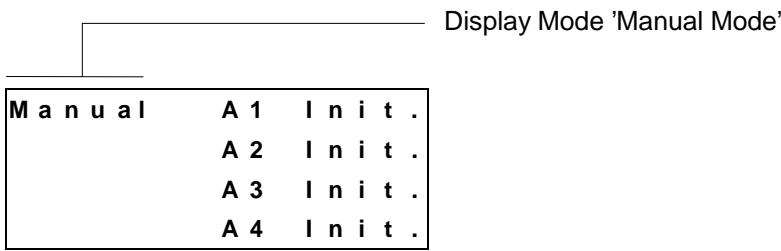

A = Homed

This information is shown when the applicable drive has been homed. For absolute encoders, the display is shown immediately; for incremental encoders it is shown after a homing operation.

`A1` to `A4` = Drive 1 to Drive 4

Individual drives are only shown if they are enabled. To accomplish this, the corresponding input 'Enable' (Connector 3/Pin 6 or 7, or Connector 22/Pin 1 or 4) must be set to 24V.

Program Input

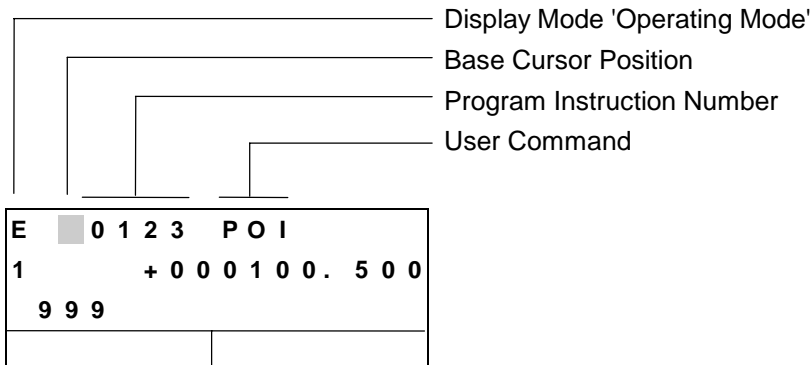

Data that belongs to the displayed user command

In this display mode, the user program can be changed via manual inputs on the keypad. By overwriting the instruction number, each program instruction between 0000 and 2999 can be retrieved and edited.

After the cursor has been returned to its base position using or , or, more simply, by pressing , the display mode can be changed again by pressing or .

The ability to enter program data via the keypad can be disabled in Parameter B001.

Parameter Input

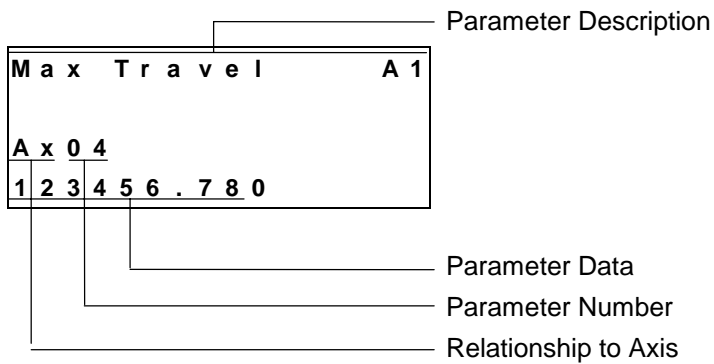

This display mode is available only in the operating mode 'Parameter.' Here, all rating data of a system is input in parameters. This display mode can only be exited by changing the operating mode. The input of parameters is described in the "Parameters" chapter.

5 Writing the User Program

5.1 Overview of All User Commands

	Command code and its meaning	Page number
A	ACC - Acceleration Change	5-10
	AEA - Bit Set / Clear	5-10
	AEO - Acceleration Override Command	5-11
	AKN - Compare Bit	5-12
	AKP - Compare Byte	5-13
	APE - Byte Set / Clear	5-14
B	BAC - Branch Conditional on Count	5-15
	BCE - Branch Conditional on Bit	5-16
	BIC - Branch Conditional on Bit Field Value	5-16
	BIO - Branch Conditional on Byte Compare	5-17
	BPA - Branch Conditional on Byte	5-18
C	CID - Change Instruction Data	5-19
	CIO - Copy Bit Fields	5-19
	CLC - Clear Counter	5-20
	CON - Continuous Operation	5-21
	COU - Count	5-21
	CPJ - Compare and Jump	5-23
	CPL - Clear Position Error	5-23
	CPS - Compare and Set a Bit	5-23
	CST - Change Subroutine Stack Level	5-24
	CVT - Converting Variable <--> Marker	5-25
F	FAK - Length Scaling Factor	5-28
	FOL - Slave (Following) Axis	5-29
H	HOM - Home Axis	5-30
J	JMP - Jump Unconditional	5-31
	JSR - Jump to Subroutine	5-31
	JST - Jump Unconditional with Immediate Stop	5-32
	JTK - Program Jump in Parallel Task	5-32
M	MAT - Mathematics	5-33
N	NOP - No Operation (Blank Block)	5-33

P	PBK - Stop Motion (Positioning Break)	5-34
	POA - Positioning, Absolute	5-35
	POI - Positioning, Incremental	5-36
	PSA - Positioning, Absolute with In-Position	5-36
	PSI - Positioning, Incremental with In-Position	5-36
R	REP - Jump on Max. Search Limit Reached	5-38
	RMI - Registration Mark Interrupt	5-38
	RSV - Restart Vector	5-41
	RTM - Rotary Table Mode	
	RTS - Return from Subroutine	5-43
S	SAC - Set Abs. Position Counter	5-44
	SET - Set Variable	5-45
	SRM - Drive to Registration Mark	5-45
V	VCC - Velocity Change Command	5-47
	VEO - Velocity Override Command	5-49
W	WAI - Wait	5-52

5.2 General Information

The basic programming is pre-set, and the user has no external access to it.

The programming language for the user program is a code similar to the BASIC programming language and was developed especially for use with this program.

The user program can have a maximum size of 3000 instructions or lines. Only one command is stored within each program instruction.

In programming, any four-digit program number between '0000' and '2999' is allowed.

The user program can be input via the keypad or loaded via the serial port.

In both cases, program loading can occur in any operating mode. A running program should not be interrupted.

The processing time for an instruction, depending on the selected cycle time, is 2 - 4 ms.

After that, the instruction with the next higher sequence number is processed (unless a jump instruction is given). In the descriptions that follow, this action is called 'proceed immediately to next instruction.'

In the case of commands involving wait states for receipt of an outcome, the process time is always extended by the cycle time required for the outcome to arrive.

In most commands, both constants and variables can be used. For clearer understanding, command examples are shown with variables and with constants. If both example lines contain a variable or a constant in the same location, only this type of value is allowed.

5.3 Program Input

Input via the Keypad

For programming via the keypad, the CLM must be in the display mode 'Program Input.'

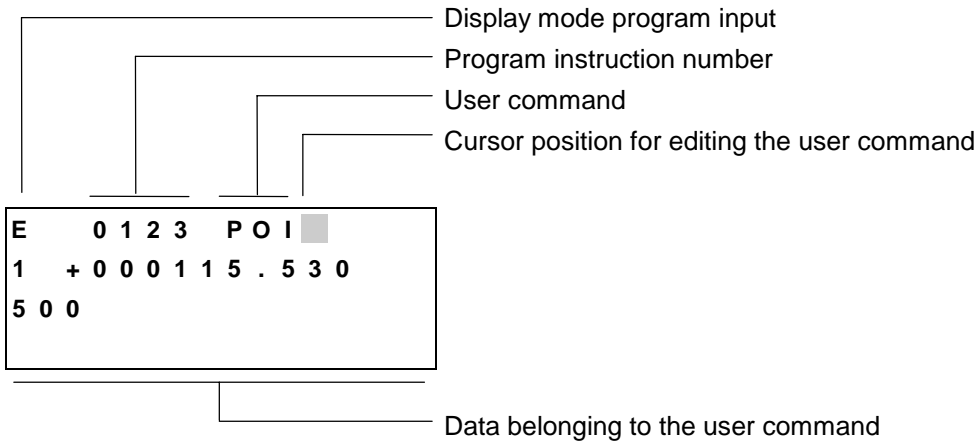

In line 1 of the input menu, the number of the program instruction to be displayed or programmed is input.

To accomplish this, move the cursor to the first position in the program instruction number by pressing and input the desired number using the data keys.

The cursor moves one space to the right after each input. Back up by pressing .

While inputting the instruction number, the command assigned to the number is displayed. After inputting the last digit of the program instruction number, the cursor moves to the first place after the user command.

In this position, it is possible to scroll through all commands in alphabetical order by pressing and .

This chapter contains an overview of all commands.



After locating the desired command, move the cursor to the data field in the 2nd (and 3rd) row using or . Here, the data for the command is input or edited using the data keys.



The new data is visible on the display, but it has not yet replaced the old data. This (replacing the old data) occurs only after saving.

To save the edited data, press the Save key.

After pressing the Save key , the information is saved. Then, the next program instruction (+1) is displayed and the cursor is placed after the command.

Cursor Movement If the cursor is placed after a command, it is moved to the first position in the instruction number by pressing .

If the cursor is in line 2 or 3, it is moved to the position after the command by pressing . From all other positions, the cursor is moved to the first position in the instruction number by pressing .

Advancing to the Next Instruction As long as the cursor is in the first row, the instruction number can be changed by pressing  and .

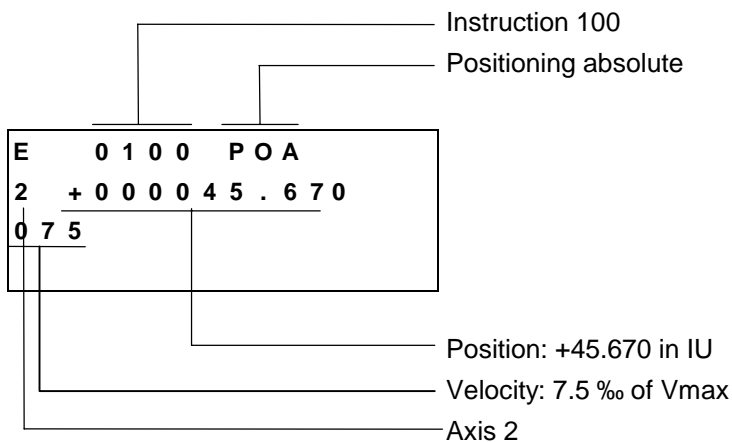

Editing data can be aborted at any time. By pressing , the cursor returns to the first position of the instruction number and the previously saved contents of the program instruction are redisplayed.

Example:



For each command, a predefined input mask is completed with data.

For each incorrectly programmed character, a '?' is displayed. A command is correctly programmed when no '?' characters appear in the instruction after pressing . If you attempt to save an instruction that contains '?,' the input is not accepted.

Using the  and  keys, the user can change to a different display. To accomplish this, the cursor must be in the input field for the program instruction number.

Loading via the Serial Port

The program can be loaded via the serial port of any computer having an RS232C or RS485 interface.

Parameters B002 and B003 control the activation and setting of the serial port.

The transmission format used by the CLM is described in the chapter entitled "Interfaces."

5.4 Starting the User Program

The user program can be started only in Automatic Mode. One exception is the 'manual vector.'

The program start address for Task 1 is reset to '0000' after each change of operating mode or CLM restart. The start addresses for Task 2 to Task 5 are set in Parameters B011 and B012.

In Task 3, the program runs as a higher-level program in every operating mode (except Parameter Mode) and is not affected by the 'Start' or 'Immediate Stop' input.

The program start command is received via the 'Start' input (refer to chapter entitled "Interfaces").

5.5 Stopping the User Program

The running program can be stopped at any time. There are two ways to accomplish this:

- 1) Stop the program externally using the 'Immediate Stop' input (refer to the chapter entitled "Interfaces").
- 2) Stop the program using the 'JST' user command.

If the operating mode was not changed after such a stop, the program continues from the point of interruption once the start command is received.

There are also two ways to interrupt the user program. Unlike a program stop, no start command is required once the cause of the interrupt is removed, i.e., the program continues from the point of the interrupt.

- 1) Program interrupt caused by signal at the 'Interrupt' input
- 2) Program interrupt caused by signal at input 'Feed angle monitoring'

Also refer to the chapter entitled "Interfaces"

In the event of an error message in the CLM, the user program is always stopped in Tasks 1, 2, 4 and 5. Continuation of the program following

correction of the problem is possible only at instruction '0000' for Tasks 1, 2, 3 and 4 for the instruction defined in Parameters B011 and B012.
Exception: refer to 'Restart' ("Functions" chapter)

5.6 Variables

The commands contain data which are contained in the instruction.

These constants can also be changed on-line via the serial interface, but not from the user program.

Using variables is an alternative. They can be programmed in place of the constants, so that this data can also be edited from the user program.

The variables are retained and all have the same format:

+12345678.123456

If a variable is used in a command, only the size of the constant that has been placed here is used. If the content of the variable is greater or less than the size of the constant, an error message is generated.

Note: The variable's operational sign is always taken into account!

e.g.

For a travel command POI, several inputs are shown.

With Constants:

POI 1 +123456.123 111

Velocity in ‰
Feed length in IU
Axis 1

For feed length, the following data size is assigned min.: -200000.000
max: +200000.000

For velocity, the following data size is assigned min.: 000
max: 999

V600 = +00123456.123456

V601 = +999.9999

V602 = +01234567.123456

V603 = -999.99999

V604 = -1234.123456

POI 1 +V600 V601

The value +123456.123 is picked up from the variable V600.

The value 999 is picked up from the variable V601.

POI 1 +V602 V603

The value of variable V602 is too large. An error message is generated.

The value of variable V603 is negative. An error message is generated.

POI 1 -V604 V601

The content of variable V604 is negative. With the operational sign from the command, the feed length becomes positive.

Available Variables

The following variables are available for NC user programs:

V600 to V999

System Variables

The system variables can only be read.

No.	Definition
V000	
V001	
V002	
V003	
V004	
V005	
V005	
V006	
V007	Analog Input 1 standardized to +/- 1
V008	Analog Input 2 standardized to +/- 1
V009	Analog Input 3 standardized to +/- 1
V010	Analog Input 4 standardized to +/- 1
V011	Actual Velocity of Master Encoder 1
V015	IDS01: Length of IDS, 5 places before decimal / 1 after
V016	IDS01: Length of IDS, 4 places before decimal / 2 after
V017	IDS01: Length of IDS, 3 places before decimal / 3 after

Fig. 5-1: System Variables

Axis Variables

The axis variables are read-only.

They exist for each axis and are assigned to variables V1xx – V4xx.

No.	Definition
Vx00	Absolute position value of motor encoder (IU)
Vx01	
Vx02	Reserved
Vx03	
Vx04	Actual velocity [IU/sec]

Legend: x = Axis Number

Fig. 5-2: Axis System Variables

5.7 Description of Commands

ACC - Acceleration Change

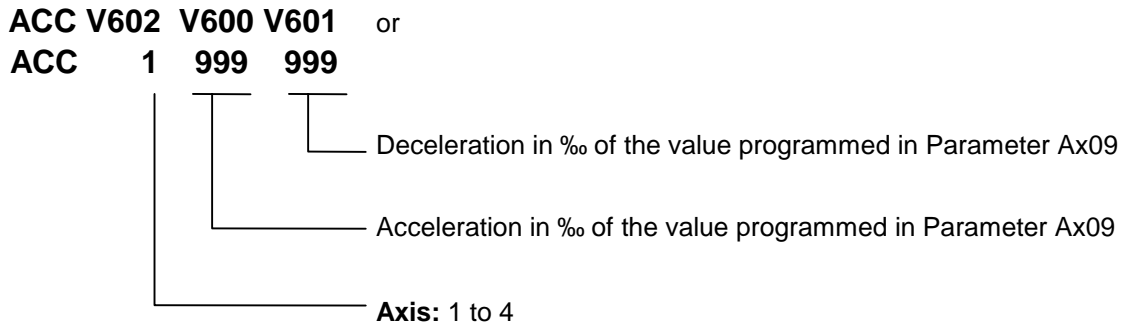

Acceptance of the new acceleration and deceleration value is immediate. The new acceleration and deceleration value is retained until changed by a new 'ACC' command.

After switching from Automatic to Manual Mode, following an error or start-up, the valid acceleration and deceleration value is always the value programmed in Parameter Ax09.

Example of how to change the acceleration value:

0000	ACC	1 999 999	- Set acceleration to 100%
0001	POI	1 +000200.000 999	- Position, then proceed immediately to next instruction
0002	AKN	MX.xx.x	- Wait until position is reached Programmed in Parameter Ax27
0003	ACC	1 500 999	- Reduce acceleration to 50%
0004	WAI	00.100	- Wait until drive unit is stabilized
0005	PSI	1 +000300.000 999	- Positioning at 50% acceleration without proceeding to next instruction
0006	WAI	02.000	- Wait 2 seconds
0007	JST	0000	- Program end in instruction 0000

Fig. 5-3: Example of Programming an Acceleration Change

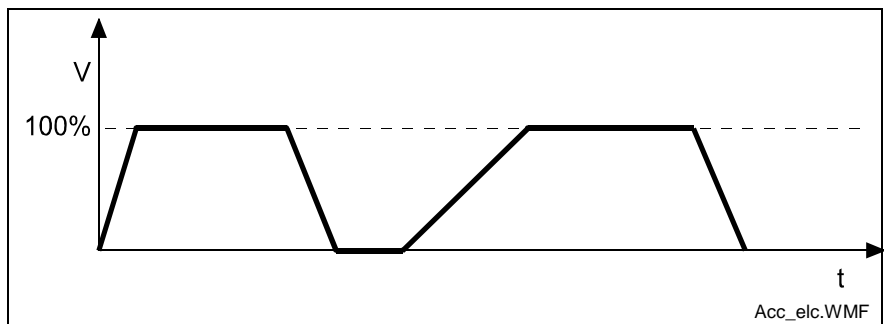
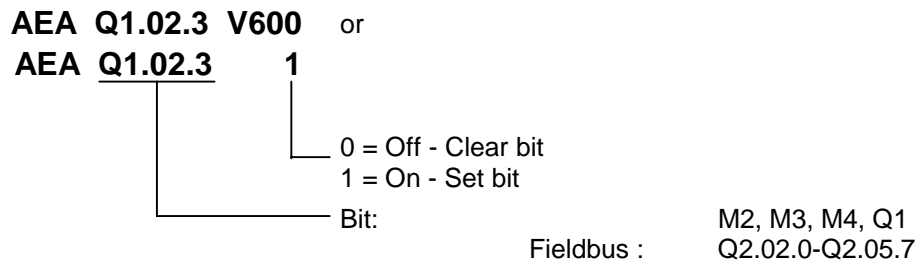

Fig. 5-4: : Example Showing Acceleration Change

The program proceeds to the next instruction following the time period of one cycle.

AEA – Bit Set/Clear



This command affects the status of the programmed bit.

Hardware outputs are set at the beginning of the following cycle. Commands in the current instruction of a task with a higher task number directly affect the changing of this bit.

The program proceeds to the next instruction following the time period of one cycle.

AEO – Acceleration Override Command

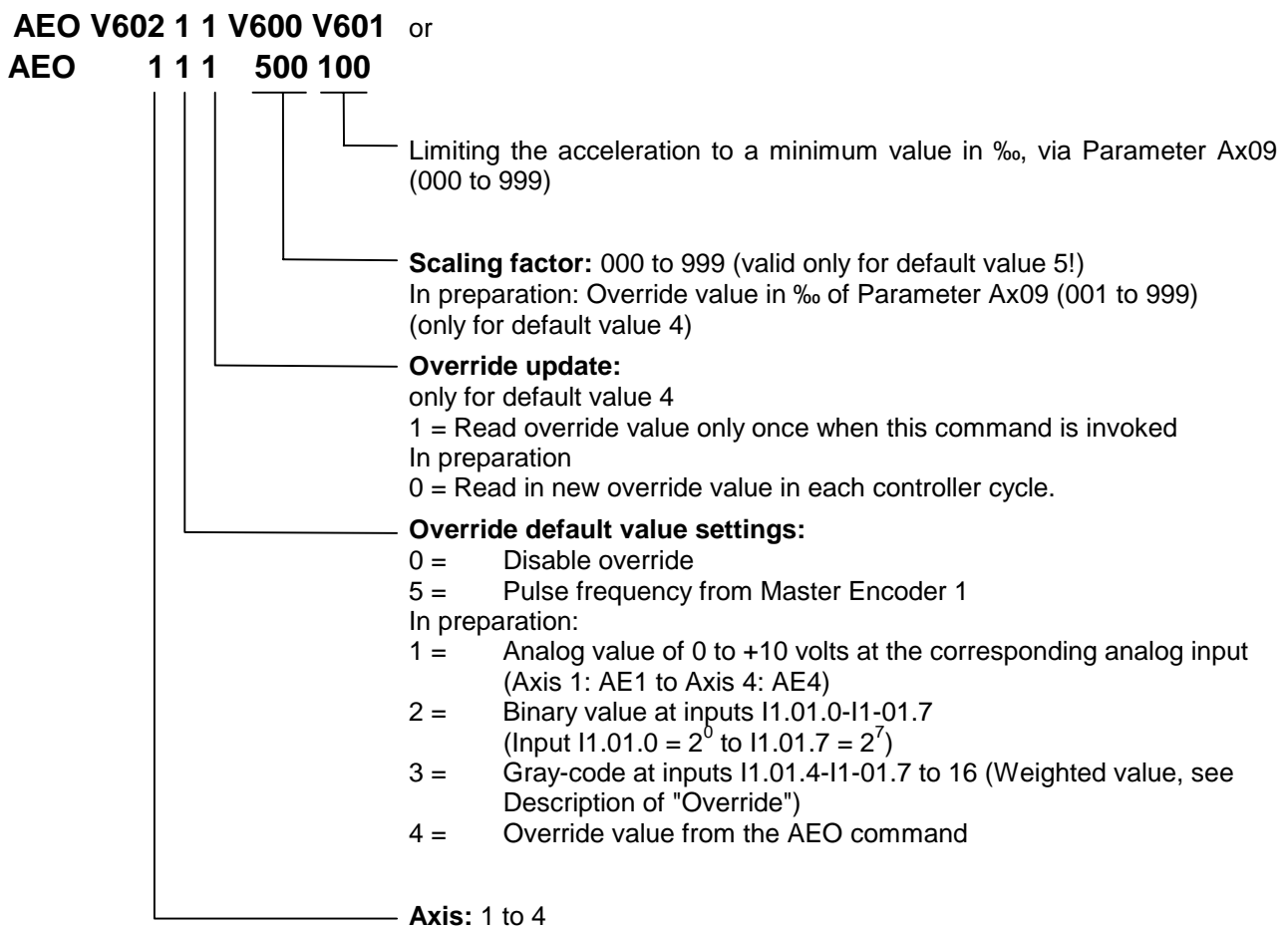

The program proceeds to the next instruction following the time period of one cycle.

Description of Override – Default value from Master Encoder 1:

This function can only be activated using the AEO command if the axis in Parameter Ax00 is set to mode 0 (normal feed axis). Additionally, Master Encoder 1 (Parameter C000 to C003) must be set up correctly in the parameters. Otherwise, the program proceeds to the following instruction immediately.

The acceleration is changed depending on the measuring wheel pulse frequency, so that the acceleration path remains constant from 0 to V (drive) = measuring wheel velocity.

The override acceleration is transferred, as for the ACC command, as soon as any positioning move in process has been completed.

The new acceleration via the override is calculated as follows:

Acceleration [IU/sec²] =

$$\text{Parameter Ax09} \times \frac{(\text{Meas. Wh. Velocity [IU / sec]})^2}{(\text{Parameter Ax06})^2} \times \frac{\text{Scaling Factor}}{1000}$$

L: IU = Input Units

Fig. 5-5: Acceleration Override

This relationship is only valid for command velocity = 999.

The value for acceleration via override may not be lower than the minimum acceleration set with the AEO command.

AKN – Compare Bit

AKN M2.02.2 V600 or
 AKN M2.02.2 1

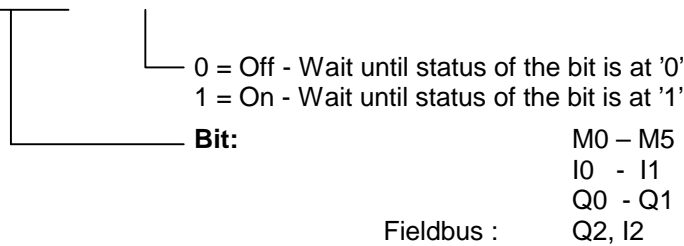

This is where the status of the programmed bit is verified. The program proceeds to the next instruction as soon as the bit assumes the desired status.

For inputs not present in the hardware, the signal level is always set to '0'.

AKP – Compare Byte

AKP M2.02 11022001

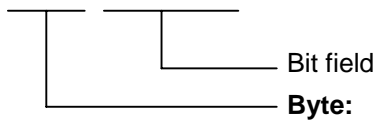

Fieldbus : M0 – M5
I0 - I1
Q0 - Q1
Q2, I2

This command represents an extension of the 'AKN' command. It can be used to verify that conditions have been met for a particular byte. The program proceeds to the next instruction if all bits have met their conditions. If not, the program waits at this instruction until all conditions for proceeding on to the next instruction have been met.

Three different conditions are possible:

- 0 = The bit is checked to see if it is set to '0.'
- 1 = The bit is checked to see if it is set to '1.'
- 2 = The bit is not checked

Example:

0008_AKP_M_0_._0_2_ _2 1 0 0 1 2 2 0
7 6 5 4 3 2 1 0

Bits 0, 4 and 5 are checked to see if they are set to '0.'
 Bits 3 and 6 are checked to see if they are set to '1.'
 Bits 1, 2 and 7 are not checked.

The program proceeds to the next instruction once all bits are in the correct state.

APE – Byte Set/Clear

APE M2.02 21022001

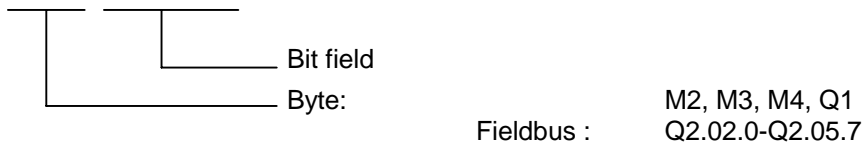

This command represents an extension of the 'AEA' command. It can be used to switch the bits in a byte. At the same time, each of the bits can be controlled independently.

Three different conditions are possible:

- 0 = The bit is set to '0'.
- 1 = The bit is set to '1'.
- 2 = The status of the bit remains unchanged

Example: a)

0008_APE_M2.02	_2	1	0	0	2	2	1	0	
		7	6	5	4	3	2	1	0

Bits 0, 4 and 5 are set to '0.'
 Bits 1 and 6 are set to '1.'
 Bits 2, 3 and 7 are not changed.

Example: b)

0008_APE_M2.02	_2	1	1	1	0	0	0	2	
		7	6	5	4	3	2	1	0

Bits 1, 2 and 3 are set to '0.'
 Bits 4, 5 and 6 are set to '1.'
 Bits 0 and 7 are not changed.

The program proceeds to the next instruction following the time period of one cycle.

BAC – Branch Conditional on Count

BAC V600 +1234 V603 or
BAC 0345 +1234 12345

Preset count
 Actual quantity offset
 Target location

Like the COU command, this command allows the program to count events, process cycles, quantities, etc.

First the quantity is incremented. Then, the actual quantity is compared with the desired target quantity. If the programmed target quantity is not reached, the program jumps to the target location. If the target quantity is reached, the actual quantity is reset to zero and the program proceeds to the next instruction.

Examples: a) Count following the event

0000	WAI	01.000
0001	PSI	1 +000050.000 250
0002	BAC	0000 +0000 00010
0003	JST	0000

Positioning is executed 10 times, and then the program waits for a new start signal.

Examples: b) Count prior to the event

0000	BAC	0002 +0000 00010
0001	JST	0000
0002	PSI	1 +000050.000 250
0003	WAI	01.000
0004	JMP	0000

Positioning is executed 9 times, and then the program waits for a new start signal.

For additional information on this command, see the explanation below under the COU command.

BCE – Branch Conditional on Bit

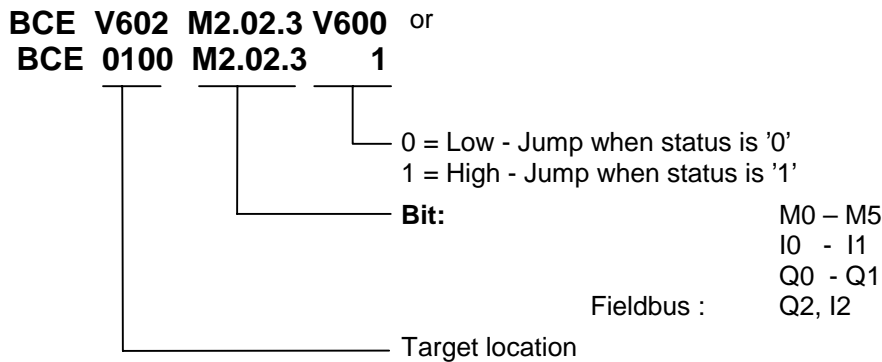

The jump is executed if the programmed bit has met the preselected condition.

If the condition is not met, the program continues at the instruction with the next higher number.

The program continues after the time period of one cycle.

BIC – Branch Conditional on Bit Field Value

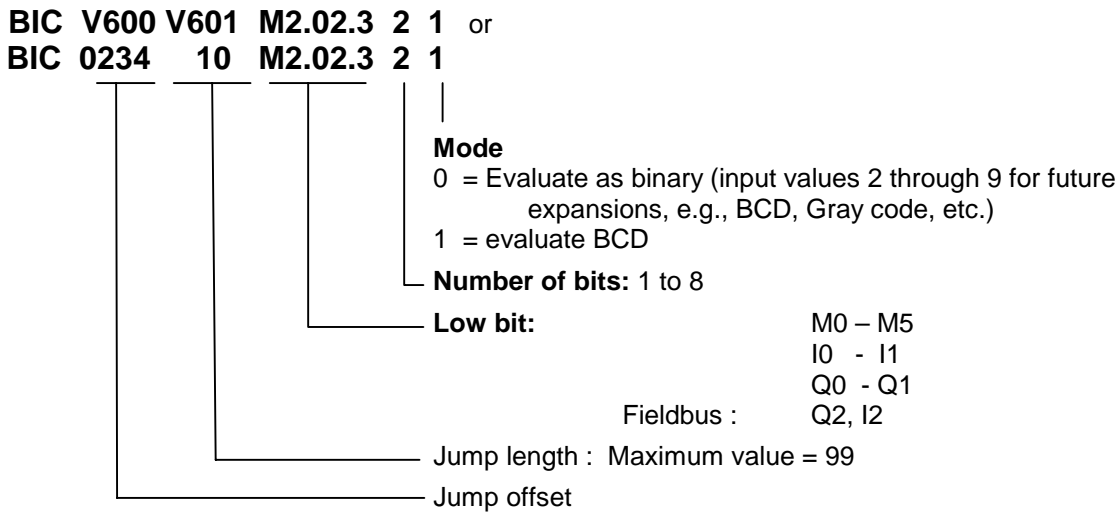

This command executes a jump to a calculated target location. The destination depends on the state of the programmed bits. Up to 8 bits are considered. If a target location of >2999 is produced, the error message 'illegal instruction' is generated.

The target location is calculated as follows:

$$Target\ Instruction = Instr.Offset + (Total\ Scaling \times Jump\ Interval)$$

Fig. 5-6: Calculation of Target Location with Binary Input Logic

Examples:

	M2.03			M2.02							
Starting bit	: 2	1	0	7	6	5	4	3	2	1	0
Current status	: 0	1	1	0	1	1	0	1	0	1	1

1) Input : BIC 0500 11 M2.02.4 5 0
 Selected bits: 1 0 1 1 0
 Binary value : 2⁴ 2³ 2² 2¹ 2⁰
 corresponds to decimal value : 16 8 4 2 1
 Target location : (16 + 0 + 4 + 2 + 0) = 22
 22 * 11 + 500 = 0742

2) Input : BIC 0300 02 M2.02.2 8 0
 Selected bits: 1 1 0 1 1 0 1 0
 Binary value : 2⁷ 2⁶ 2⁵ 2⁴ 2³ 2² 2¹ 2⁰
 corresponds to decimal value : 128 64 32 16 8 4 2 1
 Target instruction : (128 + 64 + 0 + 16 + 8 + 0 + 2 + 0) = 218
 218 * 02 + 300 = 0736

The program proceeds to the target location following the time period of one cycle.

BIO - Branch Conditional on Byte Compare

BIO V600 M2.02 Q1.06 01201201 or
BIO 0123 M2.02 Q1.06 01201201

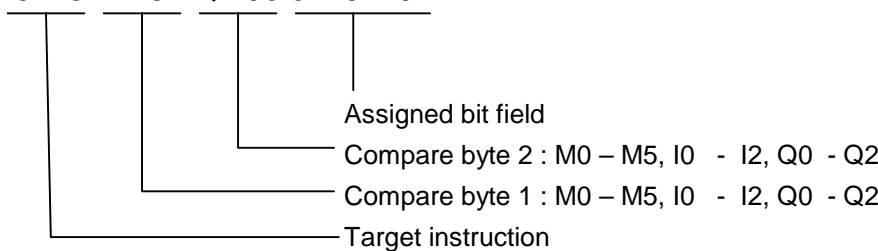

The assigned bit field is to designate which bits of the two compare bytes are to be checked for which states.

- 0 = The bit is checked to see if it is set to '0.'
- 1 = The bit is checked to see if it is set to '1.'
- 2 = The bit is not checked

The condition is met when the state of all selected bits in both compare bytes matches the state of the assigned bit field.

The jump is executed when all conditions are met.

Example:

0032_BIO_0123_M2.02_Q1.00	1	1	1	1	0	0	0	0
Compare Byte 1	1	1	1	0	0	0	1	0
Compare Byte 2	1	1	1	0	0	0	1	0
Result	1	1	X	X	0	0	X	X
	7	6	5	4	3	2	1	0

For results places with a content of 0 or 1, the condition is met. For results places with a content of X, the conditions are not met, and therefore the overall condition is not met.

The program continues after the time period of one cycle.

BPA - Branch Conditional on Byte

BPA V123 M2.02 21112212 or
BPA 0123 M2.02 21112212

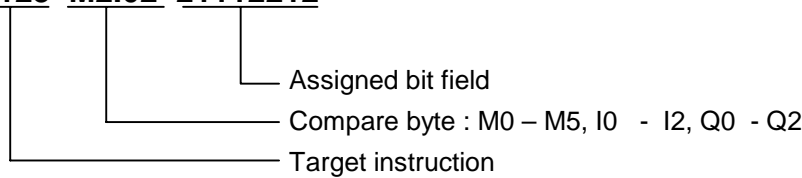

Here, the byte is checked for a met condition. At the same time, the condition can be stipulated separately for each bit. The jump to the target location is executed only if all programmed conditions are met. Otherwise, the program proceeds to the next instruction.

Three different conditions are possible:

- 0 = The condition is true if the bit is set to `0.`
- 1 = The condition is true if the bit is set to `1.`
- 2 = The bit is not checked.

The program continues after the time period of one cycle.

CID - Change Instruction Data

CID V600 0 + V601 or

CID V600 1 +000000.100

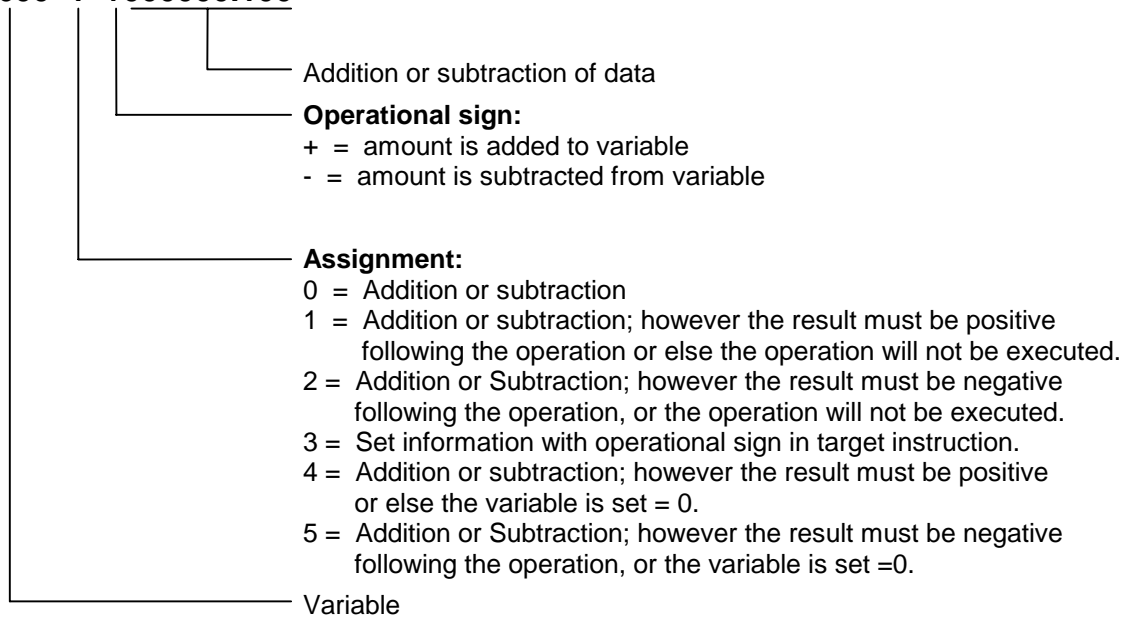

This command changes the data in a variable.

CIO - Copy Bit Fields

CIO M2.02.3 Q1.01.3 V123 or

CIO M2.02.3 Q1.01.3 07

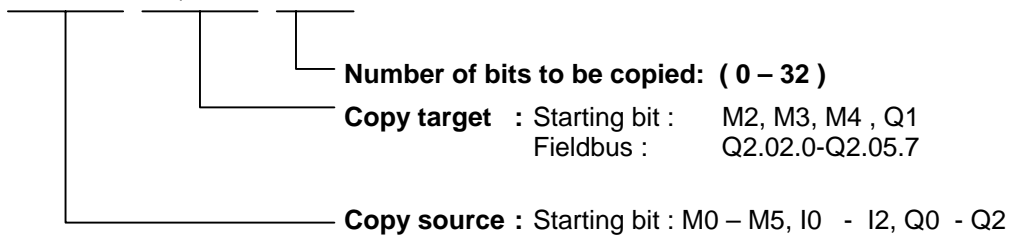

This command can be used to copy bit states. This command is particularly important for security programs. Regularly saving the data ensures that it may be possible to continue the program with the proper state settings following a fault.

Example:

```
0456 CIO I1.01.0 M2.02.0 5
```

The status of inputs I1.01.0 to I1.01.4 is copied to markers M2.02.0 to M2.02.4.

```
Status of the Input Bits = 7 6 5 4 3 2 1 0
                          1 0 1 0 1 0 1 1
```

```
Status of the Marker Bits = 7 6 5 4 3 2 1 0
before                    = 0 0 0 0 0 0 0 0
after                     = 0 0 0 0 1 0 1 1
```

The program proceeds to the next instruction following the time period of one cycle.

CLC - Clear Counter

CLC V661 or
CLC 0123

Instruction number of the counter to be set to zero

At the specified instruction number, this command resets the current value of a counter to zero. If the specified instruction contains no 'BAC' or 'COU' count command, this instruction is skipped.

The program proceeds to the next instruction following the time period of one cycle.

CON – Continuous Operation

CON V600 V601 +V602 or
 CON 1 1 + 999

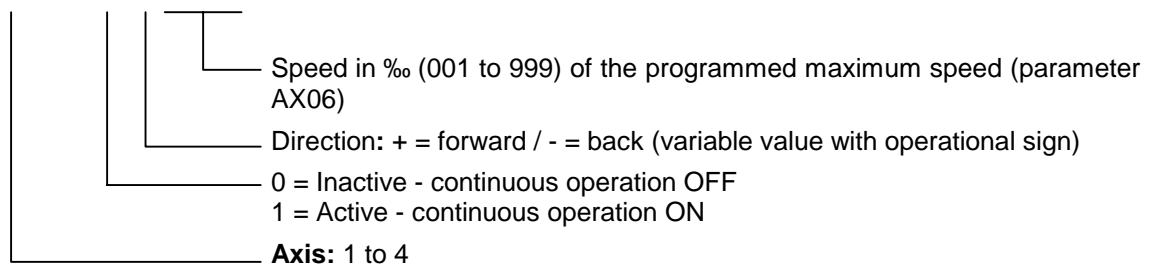

The CON command can also be used in the 'Homed' state. In that case, however, the position limit values (**Parameters Ax03** and **Ax04**) must be noted.

Within the program, continuous operation can be switched off only using the commands 'CON,' 'JST' or 'PBK.'

A change in the operating mode (e.g., from automatic to manual) switches continuous operation off.

Acceleration and deceleration are always executed using the current values.

The program proceeds to the next instruction following the time period of one cycle.

COU - Count

COU +12345 Q1.01.3 V601 or
 COU +12345 Q1.01.3 123456

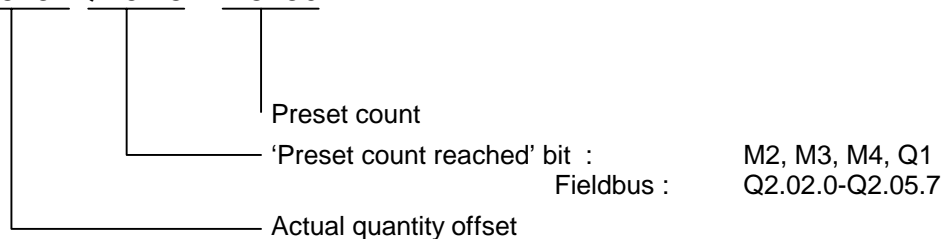

In the same way as the 'BAC' command, this command allows the program to count events, process cycles, quantities, etc.

The quantity is incremented each time the instruction is processed. Then, the actual quantity is compared with the desired target quantity. Once the target quantity is reached, the programmed bit is activated and the actual quantity is set to zero.

The programmed bit is only enabled here. If it is necessary for this bit to be disabled, this action must take place at another location within the user program.

Counters can be set at any digit position as often as desired within the user program.

Example:

```
0000 CLC 0002
0001 AEA Q1.00.4 0
0002 COU +00000 Q1.00.4 000010
0003 PSI 1 +000050.000 999
0004 WAI 01.000
0005 BCE 0001 Q1.00.4 0
0006 JST 0001
```

Positioning is executed ten times. Then, output Q1.00.4 is set and the system waits for a new start signal.

Note on actual count offset for 'COU' (Count) and 'BAC' (Branch Conditional on Count):

The counter shown on the display or using Status 4 via the serial interface can be used to check the counter status. The actual quantity is not apparent within the command itself. Once a 'COU' command ('BAC' command) has been read in, the actual quantity can be manipulated. To accomplish this, the actual quantity offset must be entered. With the 'BAC' command, the offset has one less digit.

Actual Quantity Offset	Effect
+00000 or -00000	No effect on the actual quantity
+02345 or -02345	The actual quantity offset, with its operational sign, is added to the actual quantity
000000	When the operational sign is a '0,' the actual quantity is set to zero

The actual quantity offset is significant only if the 'COU' command ('BAC' command) has been read in (even via the RS interface). When the program is running, the offset has no meaning. In the user program, the actual quantity can be reset to zero using the '**CLC**' command.

During a production cycle, it may be necessary to change the desired target quantity. This can be accomplished by overwriting the quantity within the command and then resaving.

In order to prevent unintentional repetition of a one-time correction every time the program is read in, the offset within the command itself is reset to '+00000' once the actual quantity offset has been accepted. This prevents unintentional changes from being made to the actual quantity.

Note: The current actual quantity of every counter is retained even in the event of a fault, emergency stop, change of operating mode or shutdown!

The program proceeds to the next instruction following the time period of one cycle.

CPJ – Compare and Jump

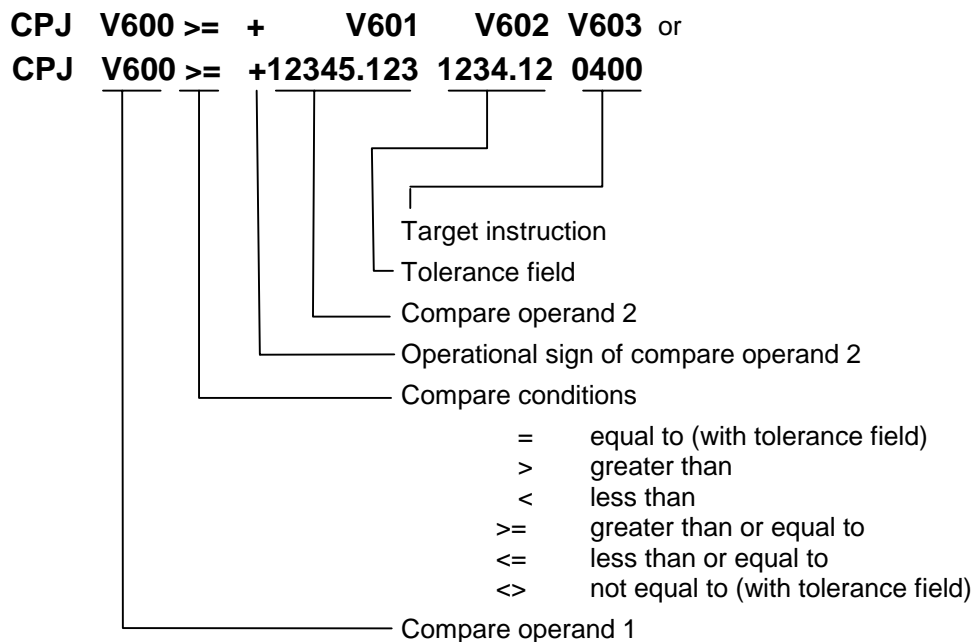

The jump to the target location is executed when the comparison has been made.

If the condition is not met, the program continues at the instruction with the next higher number.

The program continues after the time period of one cycle.

Example: CPJ V600 >= +V601 0000.00 0400

V600 = 100.000

V601 = 090.000

The command branches to instruction 400

CPL - Clear Position Error

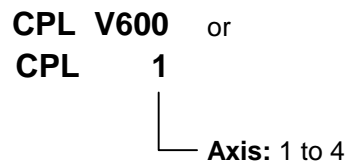

The position lag of the axis is set to zero on a one-time basis. Normally, this action is useful only for special tasks such as moving to a positive stop. When this task is performed, buildup of a substantial position lag is possible because the monitoring systems are deactivated and the performance of the drive has been affected.

The program proceeds to the next instruction following the time period of one cycle.

Note: This command directly accesses the position control circuit. It is therefore possible for unauthorized changes to be made in the values for length, position and acceleration.

CPS - Compare and Set a Bit

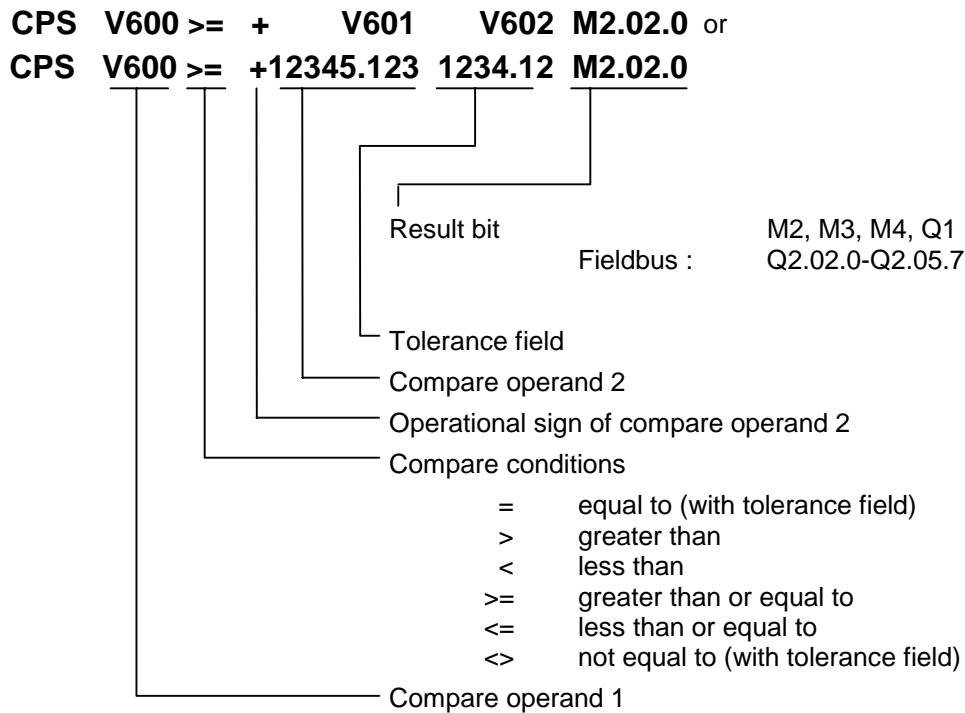

The result bit is set when the comparison has been made.

The program continues after the time period of one cycle.

CST - Clear Subroutine Stack Level

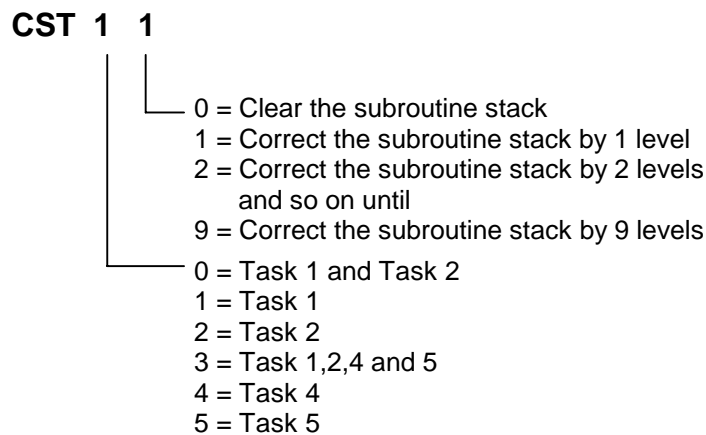

This command can be used to correct the subroutine stack.

If several subroutines are accessed within one program cycle, a direct return across several levels is not possible with the RTS command. If the subroutine stack has been corrected using the 'CST' command, a subsequent 'RTS' command will execute a direct return across several levels.

Note: If all subroutine stacks have been cleared, issuing an 'RTS' command after the 'CST X 0' command will result in an RTS nesting 'error.'

Example:

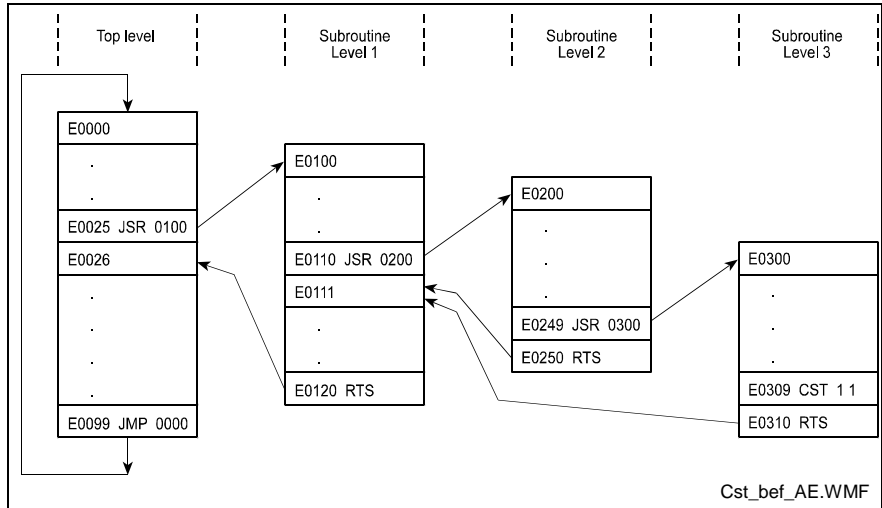
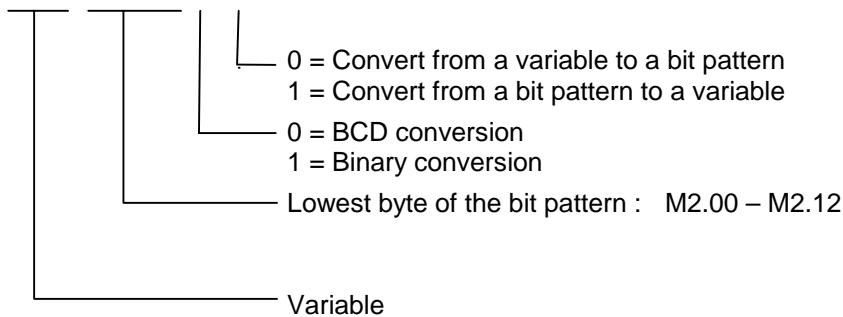

Fig. 5-7: Example Overview of Subroutine Stack Levels

CVT – Convert Variable <- -> Marker

CVT V601 M2.02 1 1



This command converts a binary or BCD bit pattern to a variable or converts a variable to a binary or BCD bit pattern.

Binary : 1 x operational sign bit (1 = negative 0 = positive)
 highest bit in the highest byte before the decimal point
 4 x bytes before the decimal point
 4 x bytes after the decimal point

BCD : 1 x byte before the decimal point (1-FF = negative 0 = positive)
 4 x bytes before the decimal point (8 decimal places)
 3 x bytes after the decimal point (6 decimal places)

The program proceeds to the next instruction following the time period of one cycle.

Example:

Convert the content of a variable to a BCD bit pattern

V600 = -87654321.654321

CVT V600 M2.00 0 0

Marker Flag	Bit Number 7654 3210	Value	Comment
M2.00	0010 0001	2 1	After decimal point
M2.01	0100 0011	4 3	After decimal point
M2.02	0110 0101	6 5	After decimal point
M2.03	0010 0001	2 1	Before decimal point M2.03.0 indicates if value is even or odd.
M2.04	0100 0011	4 3	Before decimal point
M2.05	0110 0101	6 5	Before decimal point
M2.06	1000 0111	8 7	Before decimal point
M2.07	1111 1111		Operational sign

Fig. 5-8: Marker Use According to CVT Command

Example:

Loading the Decade Switch

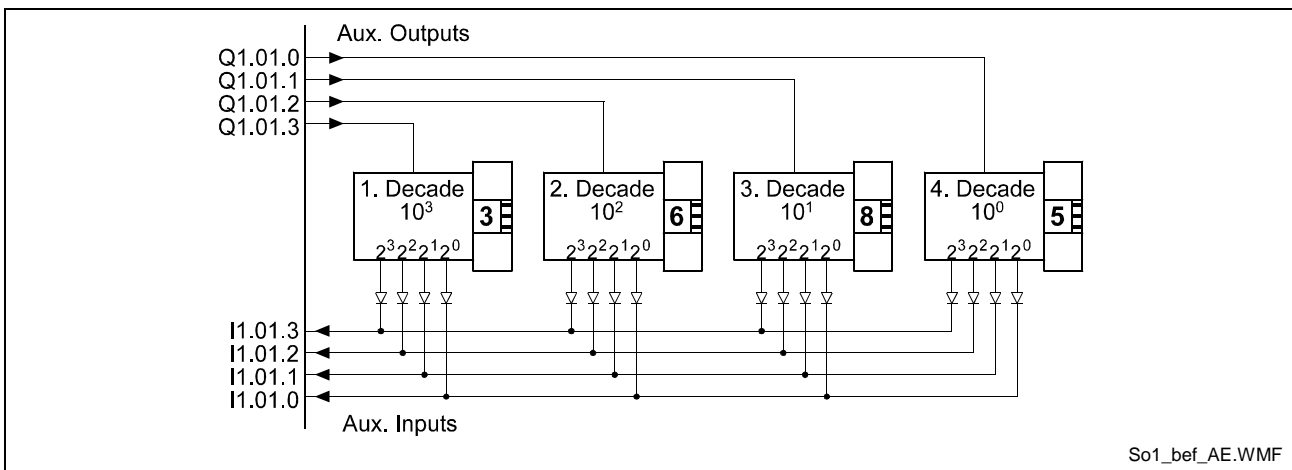

Fig. 5-9: Loading the Decade Switch

Commands	Comment
APE Q1.01 22220001	Select decade 4 10 ⁰
WAI 00.02	Wait until level is stable
CIO I1.01.0 M2.03.0 04	Load value of the 1 st decade switch
APE Q1.01 22220010	Select decade 3 10 ¹
WAI 00.02	Wait until level is stable

CIO	I1.01.0	M2.03.4	04	Load value of the decade switch
APE	Q1.01	22220100		Select decade 2 10^2
WAI	00.02			Wait until level is stable
CIO	I1.01.0	M2.04.0	04	Load value of the decade switch
APE	Q1.01	22221000		Select decade 1 10^3
WAI	00.02			Wait until level is stable
CIO	I1.01.0	M2.04.4	04	Load value of the decade switch
CVT	V600	M2.00	0 1	Write decade switch value after V600

Fig. 5-10: Programming Example: Loading the Decade Switch

FAK – Length Scaling Factor

FAK V600 V601 or
 FAK 1 1.234567

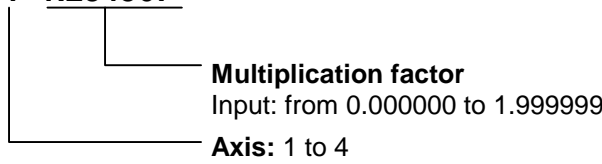

Positioning travel of the 'POA,' 'POI,' 'PSI' and 'PSA' commands is **always** the result of a preselected linear value or position and a multiplication factor.

The formula below applies for incremental positioning:

$$\textit{Positioning Travel} = \textit{Preset Length} \times \textit{Multiplication Factor}$$

Fig. 5-11: Calculation of Incremental Positioning

The formula below applies for absolute positioning:

$$\textit{Target Position} = \textit{Preset Absolute Position} \times \textit{Multiplication Factor}$$

Fig. 5-12: Calculation of Absolute Positioning

Each change in the factor applies to all subsequent positioning motions. A positioning motion already in progress is no longer affected by changes in this factor.

To make a change in the operating mode (Manual/Automatic), the multiplication factor is preset to a value of 1.000000.

0000	PSI	1 +000100.000 999	- Positioning = 100
0001	JSR	0100	
0002	FAK	1 1.234500	
0003	PSI	1 +000100.000 999	- Positioning = 123.45
0004	JSR	0100	
0005	FAK	1 1.000300	
0006	PSI	1 +000100.000 999	- Positioning = 100.03

Fig. 5-13: Example of Multiplication Factor for Positioning Motions

The program proceeds to the next instruction following the time period of one cycle.

FOL – Slave Axis

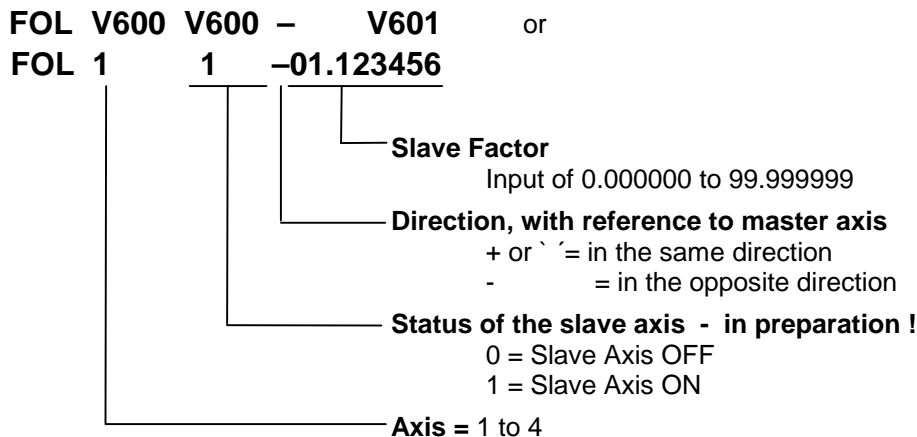

This command assigns the parameter for the axis to be used as a slave axis.

The 'FOL' command can be used to enable or disable the slave axis function. The behavior of the slave axis can also be changed by using a multiplication factor.

The positioning travel of the slave axis in IU is calculated as follows:

$$\text{Positioning Travel of Master in IU} \times \text{Multiplication Factor}$$

L: IU = input units

Fig. 5-14: Calculation of Positioning Travel of Slave Axis

In calculating the positioning travel in IU for the slave and master axes, the IU shall be considered in terms of the feed constant for the relevant axis (slave or master). Any differences in the values calculated for the input units shall also be taken into account.

Other programmed positioning motions of the slave axis (e.g., using POI or PSI) are additive in terms of velocity!

When the operating mode is changed from Manual to Automatic, or vice versa, the status (enabled or disabled) and the current value of the multiplication factor are retained.

Each time the operating mode is changed from Parameter Mode to Manual or Automatic Mode, the slave axis defaults to a multiplication factor of 1.000000.

Note: Currently, deactivating operation of the slave axis in Slave or Synchronous Mode is possible only by setting the multiplication factor to zero!

See also Section 'Slave Axis.'

The program proceeds to the next instruction following the time period of one cycle.

HOM – Home Axis

HOM V600 or
 HOM 1
 └───┬───┘
 Axis 1 to 4

This command produces an absolute measurement reference. What occurs basically corresponds to homing in Manual Mode. To accomplish this, **Parameters Ax23 through Ax25** must be programmed accordingly.

This command is not needed when the position is detected using multi-turn encoders, since they already generate an absolute measurement reference.

Otherwise, the error message 'Illegal command' is generated.

During homing, make sure that no command is processed which executes a drive motion.

A query within the program to determine whether homing has been successfully completed is accomplished by polling the 'Homed' output in **Parameter Ax24**.

Note: In general, completion of the homing routine following each 'HOM' command should be verified using an 'AKN' command.

Example:

Input in Parameter Ax24 = M2.02.0 +100 0

0011	HOM	1	- Home Axis 1
0012	AKN	M2.02.0 1	- Wait until homing is completed
0013	POA	1 +000010.000 999	- Positioning, Absolute

A detailed description of the homing function is provided in the chapter entitled 'Homing.'

The program proceeds to the next instruction following the time period of one cycle.

JMP – Jump Unconditional

JMP V601 or
JMP 0123

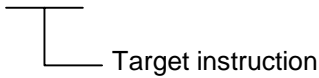

Target instruction

When it reaches this user command, the program jumps to the specified target location.

This allows the programmer to jump directly to another part of the program. This enables the main program to be divided up into fixed program blocks, which can be of great help when making changes or additions.

An unconditional jump from the end of the program to the beginning produces an endless loop. Such a program continues to run without interruption.

A valid command must be present in the target location, otherwise the error message 'Illegal command' will be generated.

The program proceeds to the target location following the time period of one cycle.

JSR – Jump to Subroutine

JSR V601 or
JSR 0123



Start instruction of the subroutine

In programs containing several identical functions, the programming can be simplified by entering repeat functions into a subroutine.

A program structure is thus clearer and shorter.

The return from a subroutine is always automatically to the instruction with the next sequential number following the instruction which initiated the jump to the subroutine.

A maximum of 127 subroutine levels are possible. At more than 127 levels, the error message 'JSR nesting' is generated.

Note: The last instruction in each subroutine must be an 'RTS' (Return From Subroutine) command. If this command is invoked without first jumping to a subroutine, the error message 'RTS nesting' is generated.

The program proceeds to the start instruction following the time period of one cycle.

JST – Jump, Unconditional with Immediate Stop

JST V611 or
JST 0123

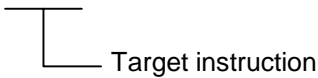

Target instruction

With this command, the program jumps to the specified target location. However, program execution stops there. The program continues only when the voltage changes from '0' to '1' at the system input 'Start.' With the new start signal, the program continues at the target location.

This command is used frequently to end a machining cycle.

If the drive is in motion, it is brought to a standstill by the programmed acceleration/deceleration values. The remaining travel distance is stored and executed after the next start. There is no loss of dimensions. Continuous operation using the 'CON' command is disabled!

The output states are not changed by a 'JST' command. In multitasking, a 'JST' command results in a programmed stop in all running tasks. Task 3 is not affected.

This corresponds to the system input: Immediate Stop

JTK – Program Jump in Parallel Task

JTK V611 1 or
JTK 0123 1

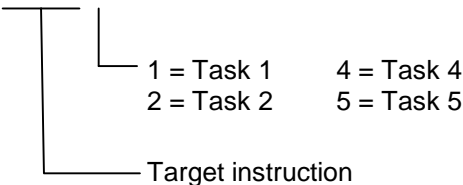

1 = Task 1 4 = Task 4
 2 = Task 2 5 = Task 5

Target instruction

This command can be used to influence program execution in one of the other tasks. Program execution within the programmed task is aborted and the task jumps to the specified target location.

- The command 'JTK_0100_2' in Task 1 causes execution of the Task 2 program to continue at instruction 100.
- The 'JTK' command can also be programmed in Task 3.
- The command 'JTK_0100_1' in Task 1 has the same meaning as the 'JMP_0100' command

The program proceeds to the next instruction following the time period of one cycle.

MAT - Mathematics

MAT V600 = V601 - + V602 or
 MAT V600 = V601 - +123456.987654

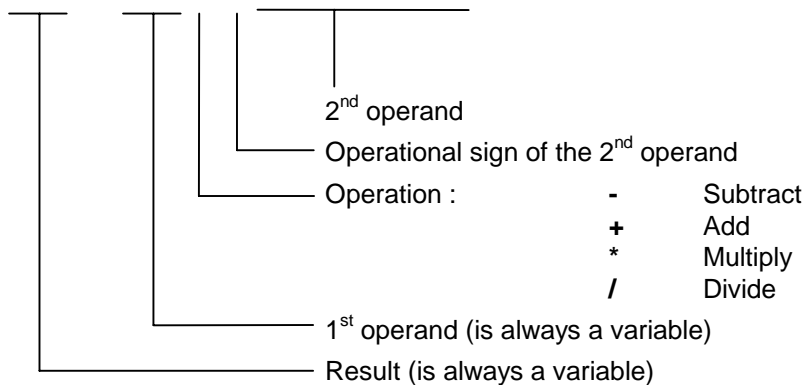

The calculation is transferred to a calculating unit. This unit functions independently from the cycle time. Furthermore, this calculating unit can be used by the other tasks. Therefore, this command can endure over the time period of multiple cycles.

The program proceeds to the next instruction when the calculation is completed.

NOP – No Operation

NOP

This command has no function and functions like a blank block. While executing the program in Automatic Mode, this command is processed like any other command.

The program proceeds to the next instruction following the time period of one cycle.

PBK – Stop Motion

PBK V600 or
PBK 1
 Axis 1 to 4

This command can be used to interrupt positioning motions in progress. The relevant axis is brought to a standstill using the current deceleration value. Following deceleration, any remaining positioning travel is ignored. If continuous operation has been enabled using 'CON,' it is disabled.

After the 'PBK' command has been executed, other positioning commands can follow immediately.

Example:

0000	CON	1 1 +999
0001	WAI	02.000
0002	PBK	1
0003	POI	1 +000050.000 100

After the 'PBK' command has been read in, the axis still moves over the deceleration distance from $V = 99.9\%$ to $V = 0$ plus 50 IU. There is, however, a continuous transition from $V = 99.9\%$ to $V = 10\%$.

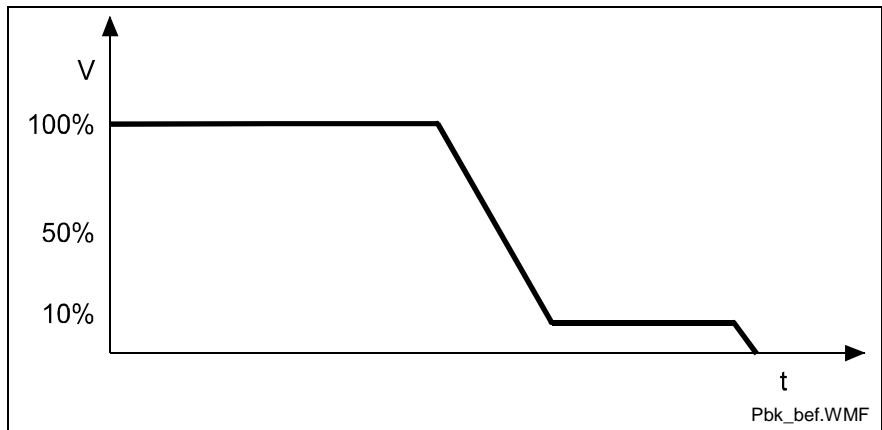
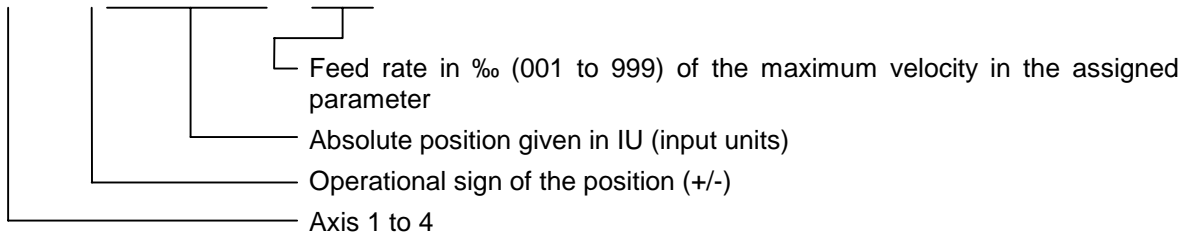

Fig. 5-15: Example of Positioning Break

The program proceeds to the next instruction following the time period of one cycle.

POA – Positioning, Absolute

POA V600 + V601 V602 or
 POA 1 +123456.789 999



From its current position, the drive is moved to the programmed absolute position referenced to the zero point.

Example: 1) current position = -100.00

```
0000 POA 1 +000200.000 999
```

The drive unit is moved 300 mm forward to the +200 position.

Example: 2) current position = +400 mm

```
0011 POA 1 +000200.000 999
```

The drive unit is moved 200 mm backward to the +200 position.

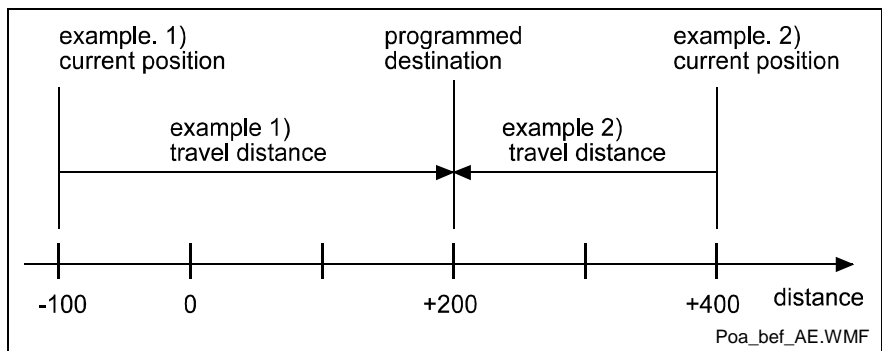

Fig. 5-16: Example of Position, Absolute

This command may be used only if an absolute measurement reference is present. This is the case when an absolute encoder is used for position detection or for position detection following a return to zero (homing) movement (see also "Homing"). Otherwise the error message 'Not homed' is generated.

Example:

```
0000 POA 1 +00010.005 999
0001 JSR 0100
0002 POA 1 +000020.003 999
0003 JSR 0100
0004 POA 1 +000030.000 500
0005 JSR 0100
```

The program proceeds to the next instruction following the time period of one cycle.

POI – Positioning, Incremental

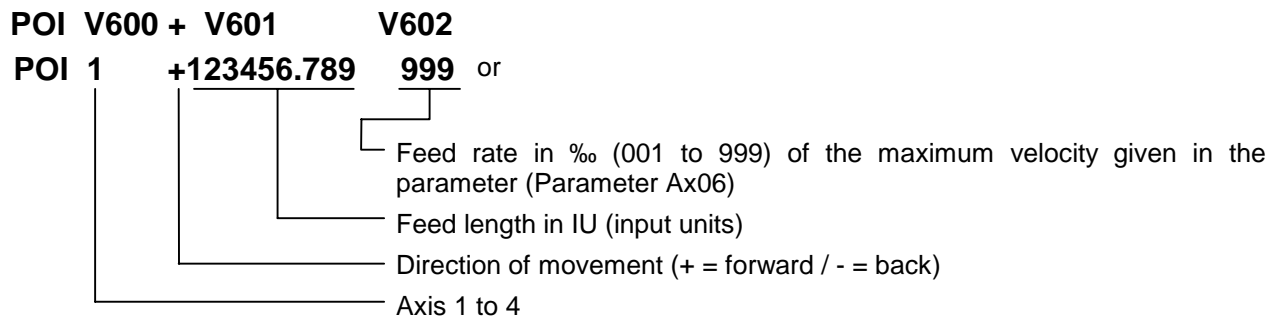

The position setpoint is incremented or decremented by the amount of the programmed value.

This feed length is adjusted to account for any remaining travel distance.

Example: The drive unit traverses the distance: -100 +200 = +100

0000	POI	1 -000100.000 999
0001	PSI	1 +000200.000 999
0002	JSR	0555
0003	JMP	0000

The program proceeds to the next instruction following the time period of one cycle.

PSA – Positioning Absolute with In-Position

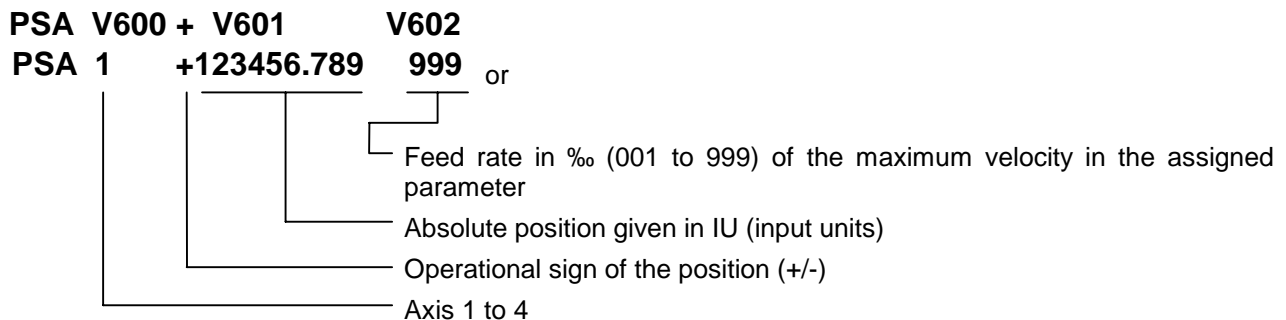

This command corresponds to the 'POA' command. However, the program proceeds to the next instruction only if the programmed absolute position has been reached.

The drive unit is considered to have reached the correct position as soon as it reaches the 'Position window' (see Parameter Ax27 'Switching Threshold') for the programmed position.

Example:

+ 100,00 = current position
 0,20 = Switching Threshold, Parameter Ax27
 ± 0,20 = Position Window

0000	PSA	1 +000200.000 999
------	-----	-------------------

The program proceeds to the next instruction when the drive unit has reached position +199.80 to +200.20.

Note: Adjustment for the highest accuracy naturally takes place even after the program has gone on to the next instruction. The adjustment accuracy is therefore not dependent on the size of the position window.

PSI – Positioning Incremental with In-Position

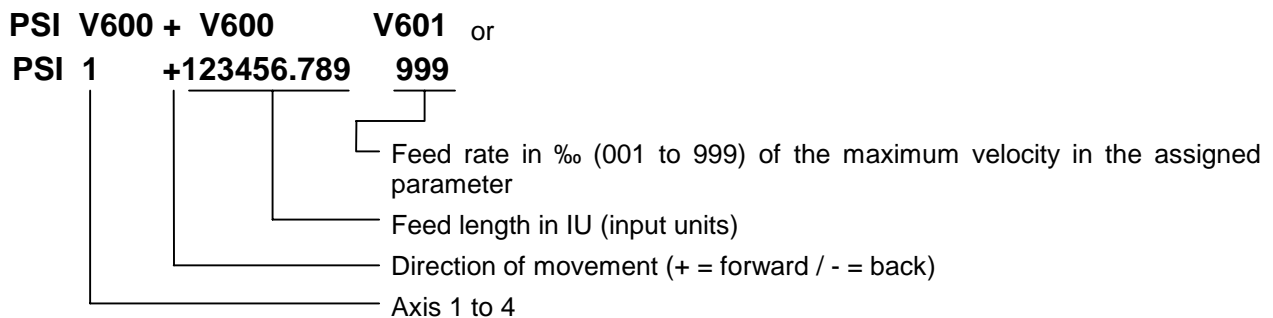

This command corresponds to the 'POI' command. However, the program proceeds to the next instruction only after the positioning procedure has been completed (position acknowledgement). This procedure is completed as soon as the drive unit has traversed the programmed feed length within the 'Position Window' (Ax27). Adjustment for the highest accuracy takes place even after the program has gone on to the next instruction.

The size of the 'Position Window' is stipulated in Parameter Ax27 (Switching Threshold).

Example:

0000	PSI	1 +000100.000 999
0001	WAI	00.500
0002	AEA	Q1.00.6 1
0003	JSR	0666
0004	JMP	0000

First, Axis 1 is started up. Once the final position has been reached and an additional waiting time of 0.5 seconds has elapsed, output Q1.00.6 is activated.

REP – Jump on Max. Search Limit Reached

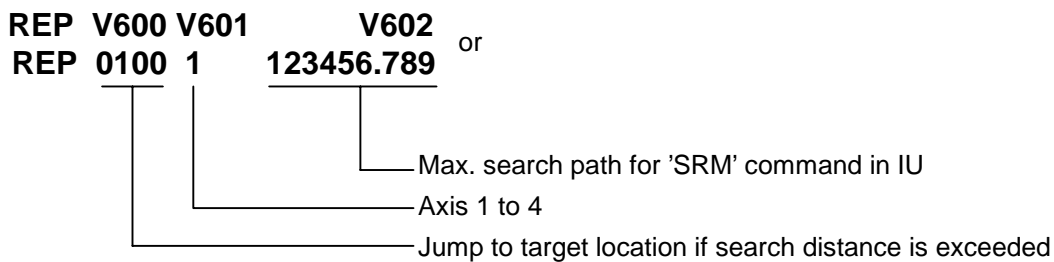

This command is a supplement to the SRM command. It permits limits to be placed on the search distance needed to find a reference marker.

If the maximum search distance entered here is exceeded without finding a reference marker, the program executes a jump to the specified target location. At the same time, the drive unit decelerates to a complete stop.

The 'REP' command must be executed immediately after the 'SRM' command. A 'REP' command alone will result in the error message 'Illegal command' when the program is executed.

The following command combinations are permissible:

- 1) Moving to a reference point without search distance limitation.

0020	SRM	1	+000000.000	+050	I1.01.0
------	-----	---	-------------	------	---------

- 2) Moving to the reference point is programmed in the 'SRM' command.

A limit of max. 500 IU is programmed in the 'REP' command. .

0030	SRM	1	+000000.000	+050	I1.01.0
0031	REP	0900	1	000500.000	

RMI – Registration Mark Interrupt

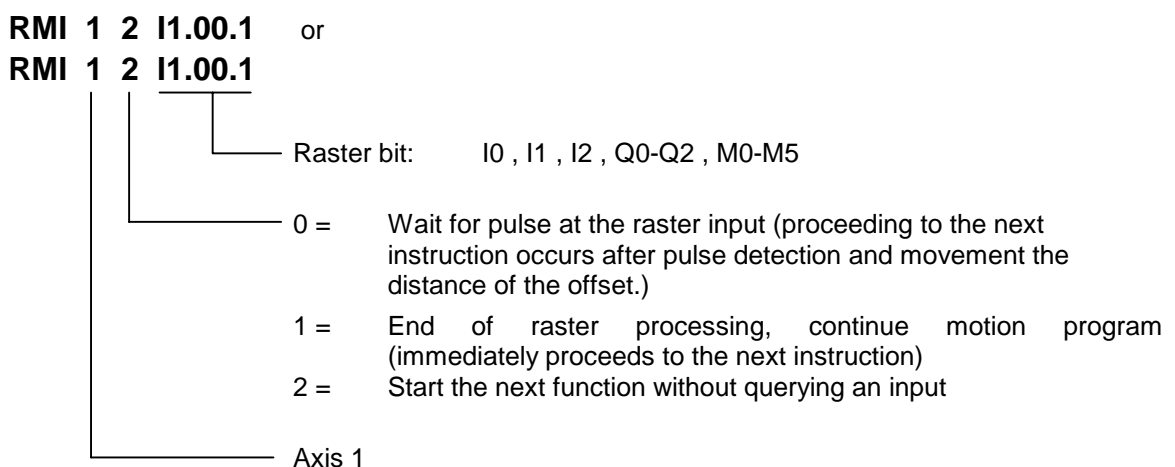

Note: This command is only available for Axis 1.

Using this command, an additional processing function can be executed, independently of the motion program for Axis 1.

The additional raster processing is initiated after detection of an input signal and movement of any offset distance for Axis 1. The rising edge of the pulse is evaluated. The motion program for this raster processing function is interrupted and continued later.

The raster program **must** be programmed in Task 2.

An offset distance can be programmed as an incremental movement (POI, PSI). This command must immediately follow the 'RMI_1_0_xx.xx.x.'

Example:

Holed sheet metal is to be sorted according to hole type. At the punching table, holes are punched in the sheet metal. Material feed is performed by the pass rolling mill. A hole is a reference signal for raster detection. Since an unknown change in length occurs during profiling, separation of the sheet metal cannot be performed using the same feed program, because it is possible that the hole pattern may drift toward the edge of the material. For this reason, separation is performed according to the reference hole. The reference hole can be detected using a light barrier, approach switch, or similar mechanism.

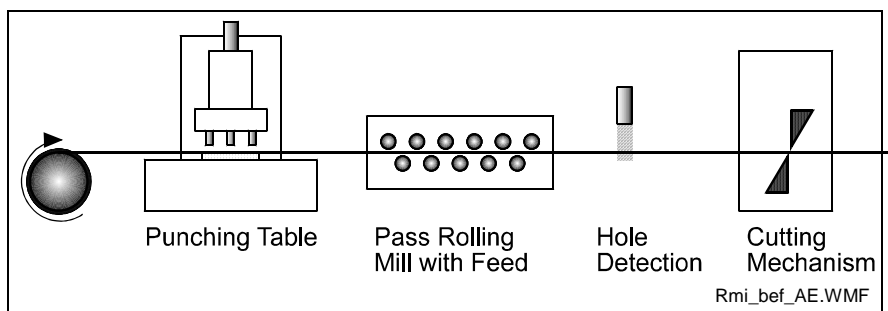

Fig. 5-17: RMI Command Example

Constraints using the RMI command:

- The 'RMI' command is not executed when a restart occurs.
- The 'RMI' command only functions correctly for feed and offset feed operations in the direction of the positioning move (e.g. 'PSI_1_+...').
- In Task 2 ('RMI' program), no feed operation besides the offset may be programmed.
- After the RMI command ('RMI_1_0_xx.xx.x') has been invoked, it is no longer possible to mask a hole.
- Detecting an additional raster before the command 'RMI_1_1_xx.xx.x' is not possible.

The velocity that can be altered using the offset feed is reset to its previous value when the feed program continues.

If the velocity indication is = 000% in the offset feed, the previous command velocity remains valid.

The functions 'Interrupt,' 'Feed Angle Monitoring,' and 'Override' are permitted.

Programming Example:

Task 1				
0000	PSI	1 +000050.000 999		- Main Program
0001	JSR	0005		- Punching Unit 1
0002	PSI	1 +000025.000 999		
0003	JSR	0009		- Punching Unit 2
0004	JMP	0000		- New Cycle
Punching Unit 1				
0005	AEA	Q1.00.0 1		- Punching Unit 1 ON
0006	WAI	00.200		- Wait
0007	AEA	Q1.00.0 0		- Punching Unit 1 OFF
0008	RTS			- back to Main Program
Punching Unit 2				
0009	AEA	Q1.00.1 1		- Punching Unit 2 ON
0010	WAI	00.200		- Wait
0011	AEA	Q1.00.1 0		- Punching Unit 2 OFF
0012	RTS			
Task 2				
0200	RMI	1 0 I1.01.7		- Wait for raster signal and movement of the offset distance
0202	PSI	1 +000015.500 500		- Offset distance from the raster position
0202	JSR	0210		- Tool program
0203	RMI	1 1 I1.01.7		- Perform feed operation in the Main Program
0204	JMP	0200		- New Cycle
Tool Program				
0210	AEA	Q1.00.2 1		- Cutting Mechanism ON
0211	WAI	00.250		- Wait
0212	AEA	Q1.00.2 0		- Cutting Mechanism OFF
0213	WAI	00.250		- Wait
0214	RTS			

Fig. 5-18: RMI Command Programming Example

RSV – Restart Vector

RSV 1 V600 1 0 0 1 1 or

RSV 1 0000 1 0 0 1 1

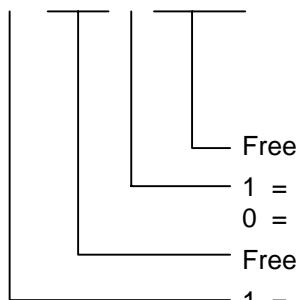

Free

1 = 1 = Restore status of outputs

0 = 0 = Status of outputs has **not** been restored

Free

1 = Restore status from before interrupt (but not the output status) and terminate the Re-Start Program.

0 = Re-Start Program not yet terminated

This command affects the execution of the Re-Start Program. It selectively restores the status of the interrupted program and then terminates the Restart Program.

Example: B016 = 2000

Program 1:

2000	RSV	1 0000 10000	- Terminate Re-Start Program and completely restore status
------	-----	--------------	--

Program 2:

2000	AKN	I1.00.4 1	- Wait for input
2001	WAI	01.000	- 1-second wait time
2002	RSV	1 0000 10000	- Terminate Re-Start Program and completely restore status

Program 3:

2000	RSV	0 0000 10000	- Restore status of outputs
2001	AKN	I1.00.4 1	- Wait for input
2002	WAI	01.000	- 1-second wait time
2003	RSV	1 0000 00000	- Terminate Re-Start Program and completely restore status, except for outputs

See also Section 'Re-Start.'

The program proceeds to the next instruction (or the instruction in the interrupted program) following the time period of one cycle.

RTM – Rotary Table Mode

In preparation
 or
RTM 1 V600
RTM 1 0

Rotary table mode:
 0 = mode accepted from **Parameter Ax05**
 1 = shortest distance
 2 = programmed direction
 >2 = no change in mode

Axis 1 to 4

Rotary table must be preselected under the type of motion in **Parameter Ax00** and the axis must be homed.

The **parameter setting Ax05** is active after each restart or error acknowledgement, or after termination of Parameter Mode. Changing between Manual and Automatic Modes does not change the current Rotary Table Mode.

RTS – Return from Subroutine

RTS

As described for the 'JSR' command, a subroutine must be concluded with an 'RTS' return command.

If several subroutine levels have been accessed in one program cycle, a return from a higher subroutine level leads first to the next lower subroutine level rather than directly back to the main program.

Example:

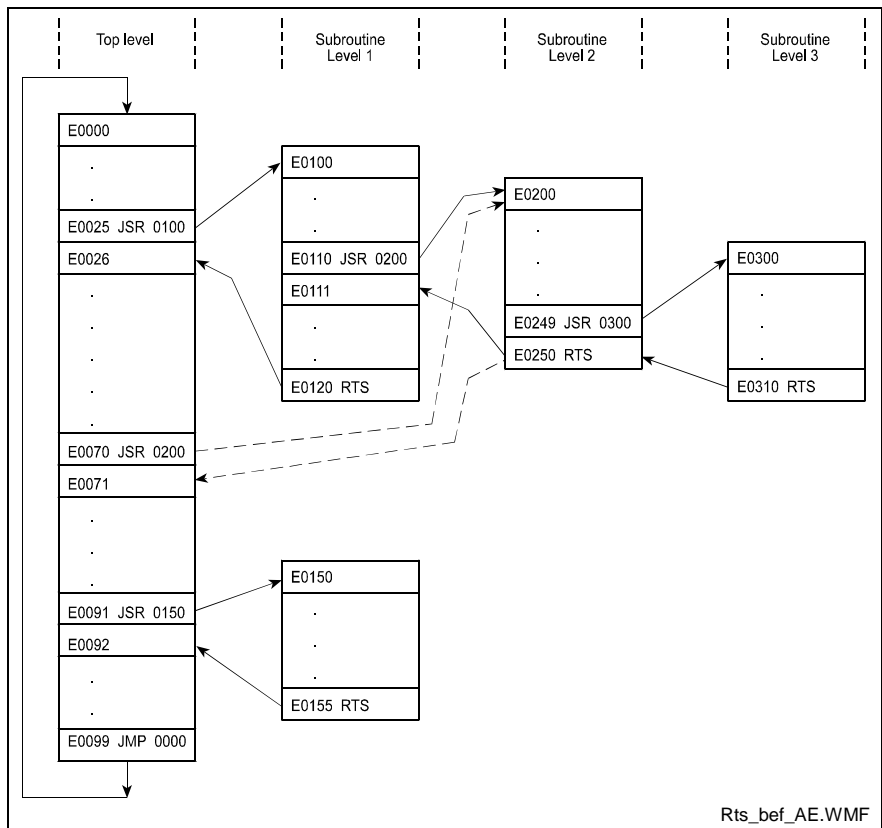
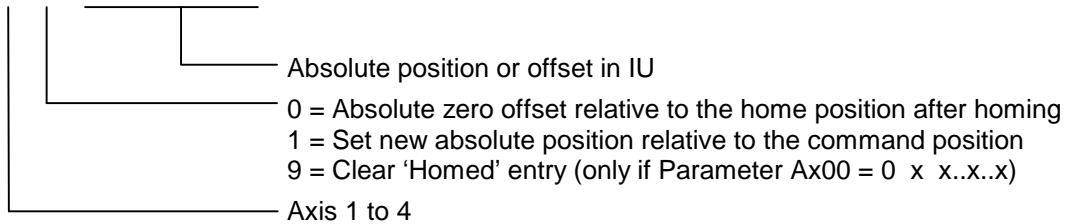

Fig. 5-19: Example of Return from Subroutine Levels

The program proceeds to the next instruction following the time period of one cycle.

SAC - Set Abs. Position Counter

SAC 1 0 +12345.678



The axis must be homed, otherwise the error message 'Axis not homed' is generated. The command is executed correctly only when the axis signals 'Position reached' (Parameter Ax27).

Example:

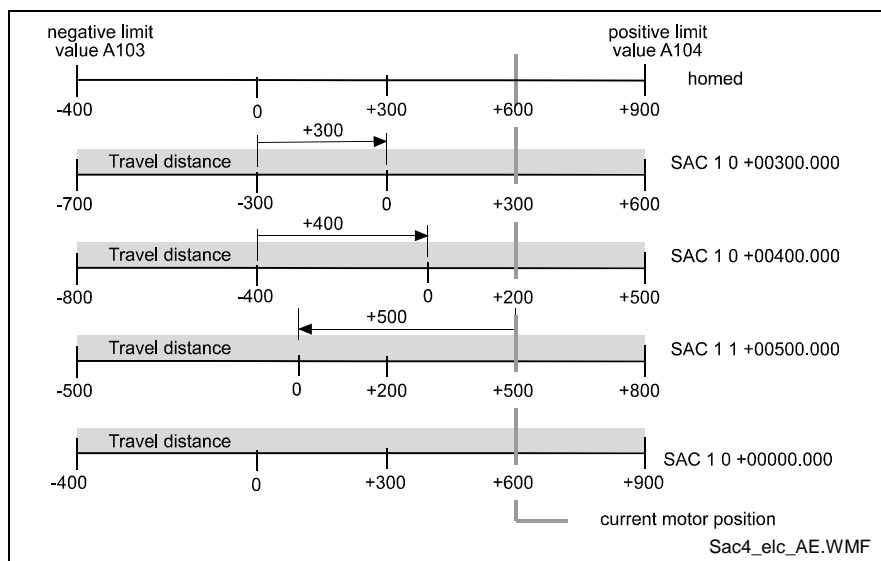

Fig. 5-20: How the SAC command works

The coordinate system is offset by a value of x for the command SAC 1 0 +xxxxx.xxx. The offset can be cancelled via command SAC 1 0 +00000.000.

Furthermore, the actual position can be defined as a value using the command SAC 1 1 +xxxxx.xxx. The coordinate system is thus shifted. This way, the coordinate system is offset.

The first time this command is used in Application Type Ax00 = 0 x, the actual axis position is set to the offset value of the SAC command. For further uses of the SAC command while the drive is homed, the offset is processed as shown in the figure.

The program proceeds to the next instruction following the time period of one cycle.

SET – Set Variable

SET V600 = + V601 or
 SET V600 = +12345678.123456

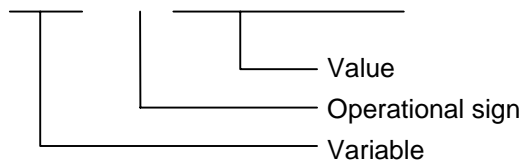

Using this command, variables can be set from the program or copied from another variable.

The program proceeds to the next instruction following the time period of one cycle.

SRM – Drive to Registration Mark

SRM V602 + V600 +V601 I1.01.0 or
 SRM 1 +123456.123 + 123 I1.01.0

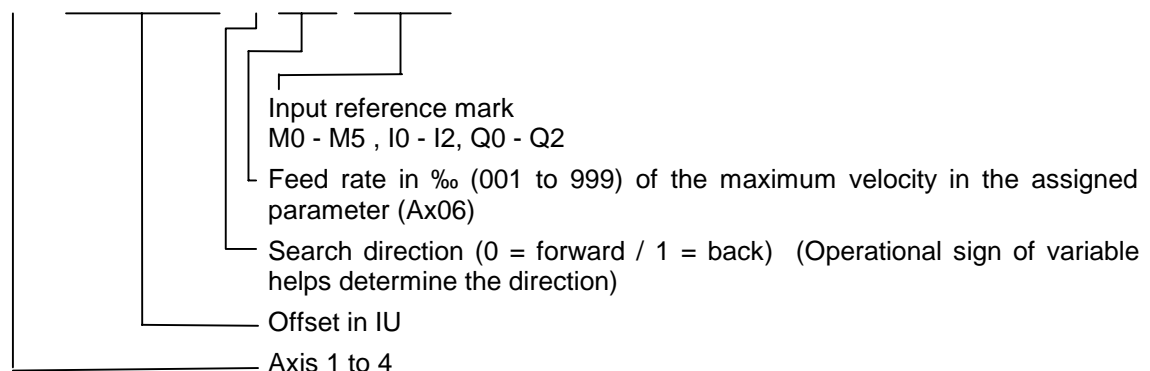

This command can be used to search for a reference marker at any time. The axes, the search direction, the search velocity and the reference signal input can be selected by the user. Once the command is invoked, the search for the reference marker proceeds at the preselected velocity. The reference marker is detected by means of the rising edge of a pulse (from 0V to 24V) at the programmed input.

As soon as the reference marker is detected, the program proceeds to the next instruction.

If a value of I0.01.7 is programmed for the reference marker input, then that input (connector X3 / pin 16) is selected as the reference marker input. This input has no hardware debouncing. This input can also initiate an interrupt. This input is therefore able to detect the reference marker substantially more accurately (within a time frame of approx. 100 microseconds).

Offset dimension:

The move to an offset dimension (referenced to the reference point) is accomplished immediately after detection of the reference point.

It is also possible to limit and monitor the search travel until the reference marker is found (see also the 'REP' command).

Note: No new absolute measurement reference (zero point) is created using the 'SRM' command. This is possible only through the homing function.

Detection of the reference point occurs within a time frame of 2 to 4 ms (controller cycle time). If a highly accurate reference point is required, the search velocity must be reduced. The achievable accuracy is determined as follows:

$$\text{SearchVelocity in IU/s} \times 2 \times \text{CycleTime [s]}$$

L: IU = Input Units
s = seconds

Fig. 5-21: Calculation of the Search Velocity

Example: The maximum velocity is 200 IU/s. The cycle time is 2 ms. A normal input with a debouncing time of the time period of one cycle is selected.

```
0000 SRM 1 +000000.000 +500 I1.01.0
```

The search velocity is 200 IU/s * 500 ‰ = 100 IU/s. The accuracy is > 0.4 mm.

With the system input, Connector X3 / Pin 16, there is no debouncing time and the detection time is approx. 0.1 ms. The accuracy is > 0.01 IU

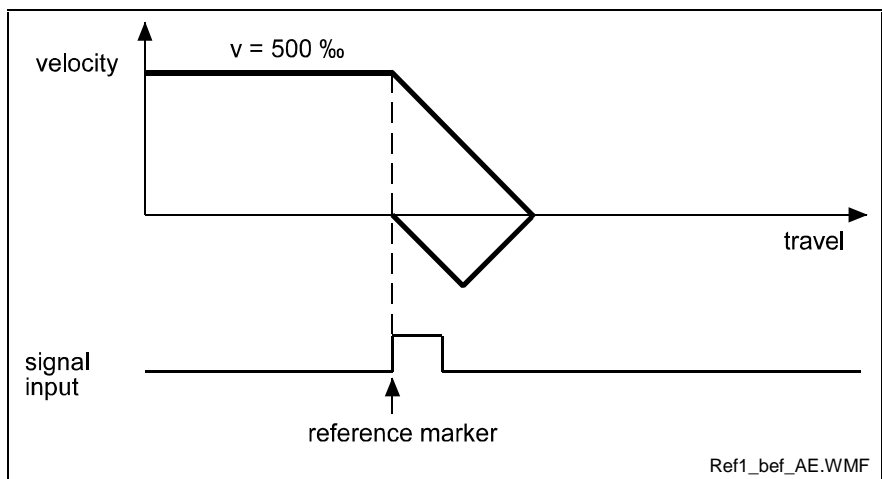

Fig. 5-22: Example of Movement to a Reference Mark

Example of moving to a reference mark with offset programming:

```
0000 SRM 1 +000200.000 +500 I1.01.0
```

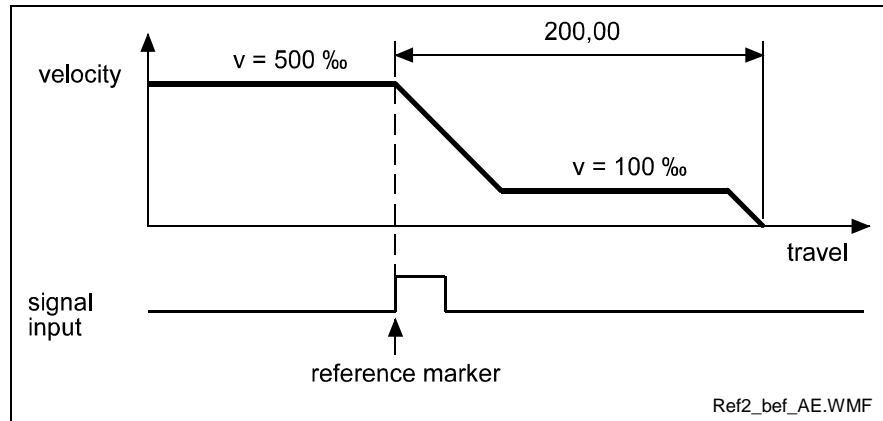
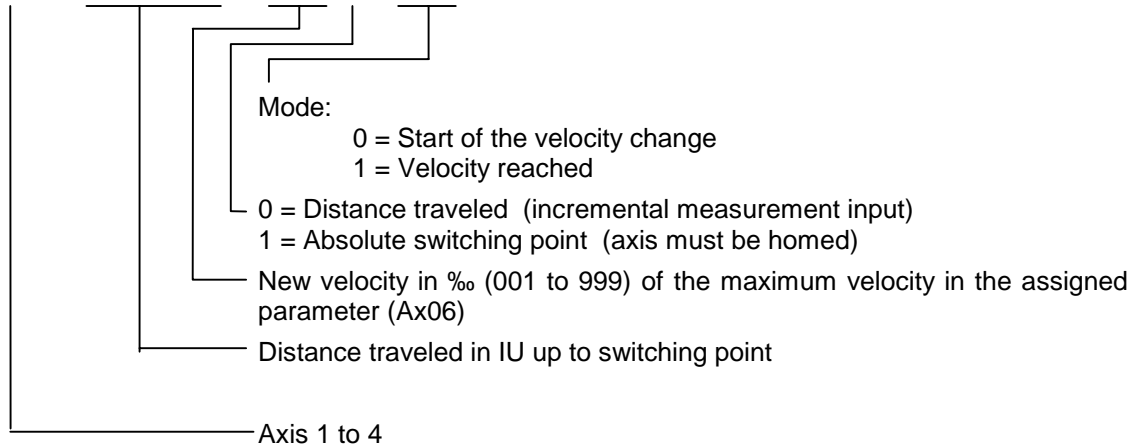

Fig. 5-23: Example of Moving to a Reference Mark with Offset Programming

VCC – Velocity Change Command

```
VCC V603 + V600 V601 0 V602 or
VCC 1 +123456.789 999 0 1
```



Mode 0 : Start of velocity change

Velocity changes are always referenced to the most recently initiated positioning function.

The program proceeds to the next instruction immediately after the distance programmed in the VCC command, referenced to the start position of the most recent positioning function, has been traversed.

A change in velocity can take place only when the positioning functions do not include position acknowledgement (POI, POA).

The position portion in the last VCC value must be smaller than the previously started positioning function, otherwise that VCC command is not executed and the program proceeds to the next instruction.

Example:

The actual start position is 0 mm.

0000	POI	1 +000100.000 999	- Move 100 IU, then proceed to next instruction
0001	VCC	1 000050.000 250 0 0	- after 50 IU, change to 25% velocity
0002	VCC	1 000075.000 500 0 0	- after 75 IU, change to 50% velocity
0003	VCC	1 000090.000 100 0 0	- after 90 IU, change to 10% velocity
0004	AKN	M2.00.0 1	- Wait until target position is reached
0005	WAI	01.000	- End of cycle, wait 1 second
0006	JMP	0000	- Repeat program

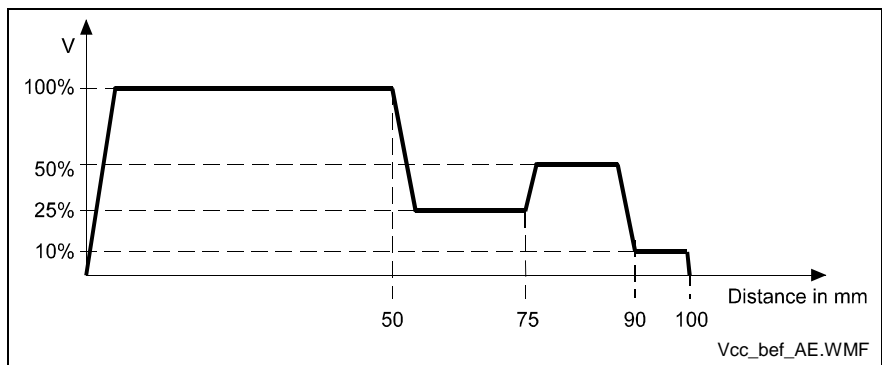

Fig. 5-24: Change Velocity

Mode 1 : Velocity reached

This command changes the velocity of a positioning move in progress such that the desired velocity is reached at the specified absolute position.

The program proceeds to the next instruction immediately after the drive unit begins changing its velocity. This point depends on the acceleration, the difference in velocity and the position lag.

If this point has already been reached or exceeded when the VCC command arrives, the program proceeds immediately to the next instruction, accepting the new velocity.

The axis must be homed to zero.

Example:

The actual start position is 0 mm.

0000	POA	1 +000200.000 999	- Move to absolute position +200 IU
0001	VCC	1 +000100.000 500 1 1	- at position +100 IU, V = 50%
0002	VCC	1 +000180.000 100 1 1	- at position +180 IU, V = 10%
0003	AKN	M2.00.1 1	- Wait until target position is reached
0004	WAI	01.00	- End of cycle, wait 1 second

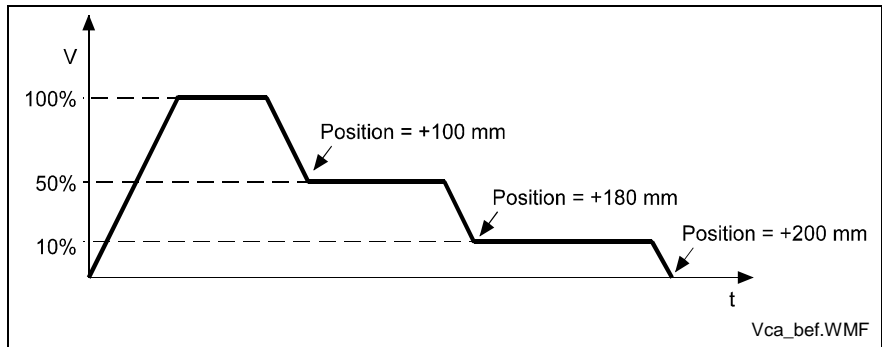
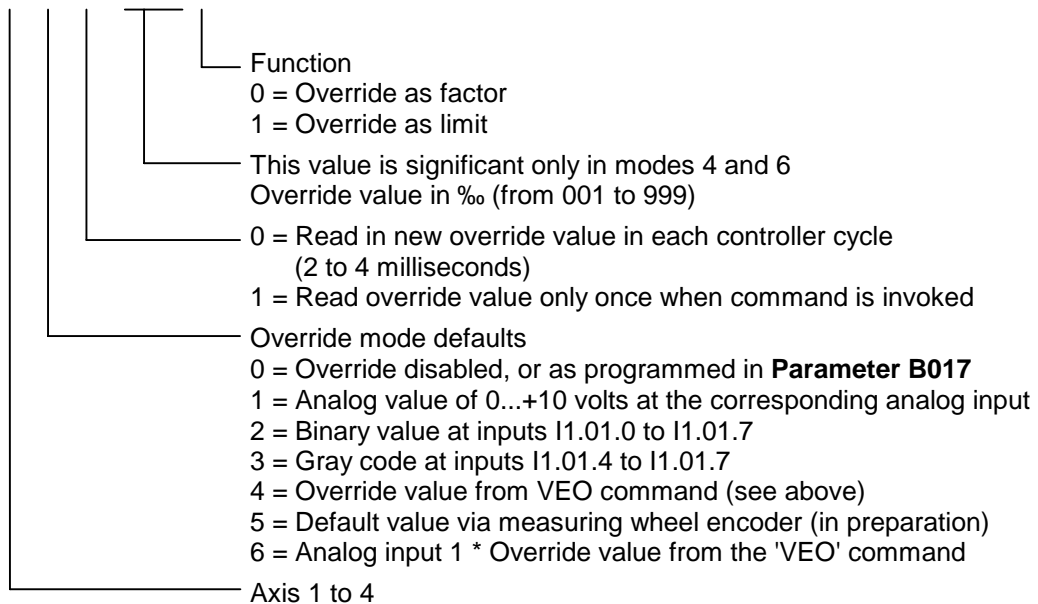

Fig. 5-25: Change Velocity (Absolute Position)

VEO – Velocity Override Command

VEO V601 1 0 V600 1 or
 VEO 1 1 0 500 1



This command produces a reduction in the velocity of all of the programmed traversing commands.

With the 'Override as factor' function, the override value is multiplied by the programmed velocity from the commands.

With the 'Override as limit' function, the override value is multiplied by the programmed velocity from the parameter Vmax (**Param. Ax06**), and therefore limits the velocity. Activation of an override function using the VEO command has priority over activation of any function within **Parameter B017**.

Once a 'VEO' command has been invoked, it applies to all subsequent motions until it is canceled. See also the examples on the following pages.

Any change in operating mode between 'Automatic' and 'Manual' cancels the override function invoked by the 'VEO' command. The values can be changed again in Task 3.

The program proceeds to the next instruction following the time period of one cycle.

Description of Override Mode 5 (in Preparation)

This function can only be activated using the 'VEO' command if the axis is designated as a 'Normal Axis' in Parameter Ax00. Additionally, Master Encoder 1 must be set up correctly in the parameters (Parameter C000, C001 and C002). Otherwise, the program proceeds to the following instruction immediately.

The following relationship applies:

$$\text{Override Value} = \frac{\text{Meas. Wheel Velocity} [\text{IU} \text{ - Meas. Wh. / sec}]}{\text{Max. Velocity} [\text{IU} \text{ - Motor / sec}]} \times \text{Multiplier}$$

L: IU - Input Units

Fig. 5-26: Formula for Default Values via Measuring Wheel Encoder

The maximum velocity is taken from **Parameter Ax06**.

The multiplier is always equal to 1 after each restart or error acknowledgement, or after termination of Parameter Mode.

If the axis reaches a velocity of more than 1.25 times Vmax (Parameter Ax06), because of a programming error or excessive velocity of the measuring wheel encoder, the error message ' max. Override Ax ' is issued.

However, the velocity of the drive is limited to Vmax in any case, for measuring wheel encoder speeds > Vmax.

Examples: 'VEO' - Velocity Override

0000	BPA	0004 M2.02 21022222	- program selection 1; jump to Program A
0001	BPA	0006 M2.02 20122222	- program selection 2; jump to Program B
0002	BPA	0008 M2.02 21122222	- program selection 3; jump to Program C
0003	JMP	0000	- Input 0 selected; wait loop
0004	VEO	1 4 1 999 1	- Program A; velocity unchanged
0005	JMP	0009	- Execute positioning function
0006	VEO	1 4 1 700 1	- Program B; velocity limited
0007	JMP	0009	- Execute positioning function
0008	VEO	1 4 1 500 0	- Program C; reduce velocity
			- Execute positioning function
0009	POI	1 +000100.000 999	- Move 100 mm and proceed to next instruction
0010	VCC	1 +000035.000 800 0 0	- after 35mm, change to 80% velocity
0011	VCC	1 +000050.000 600 0 0	- after 50mm, change to 60% velocity
0012	VCC	1 +000065.000 400 0 0	- after 65mm, change to 40% velocity
0013	VCC	1 +000080.000 200 0 0	- after 80 mm, change to 20% velocity
0014	AKN	M2.02.4 1	- Wait until switching threshold is reached
0015	WAI	01.000	- At end of cycle, wait 1 second
0016	JMP	0000	- Jump to program selection

The above example from the program generates the following velocity profiles:

1) Program A – Unaffected velocity profile

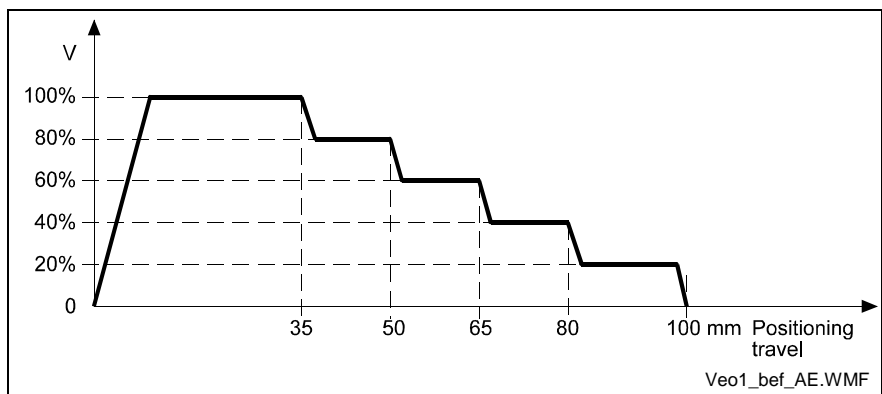

Fig. 5-27: VEO Command – Change Velocity

- 2) Program B – Velocity limited to 70% from instruction number 0006

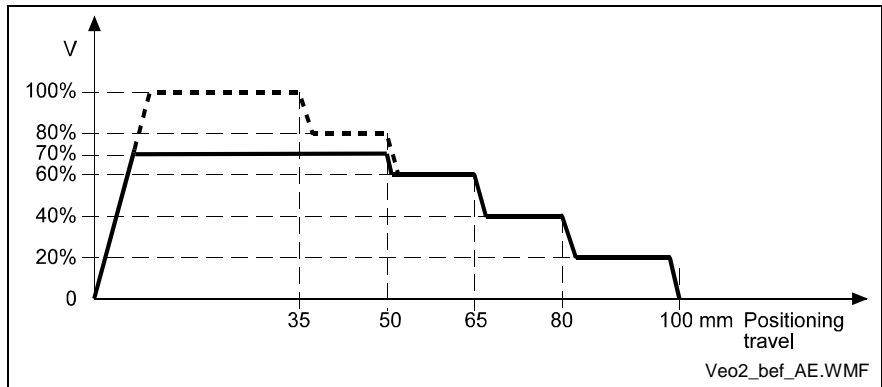

Fig. 5-28: VEO Command – Limit Velocity to 70%

- 3) Program C - Multiplication by factor of '500' from instruction number 0008

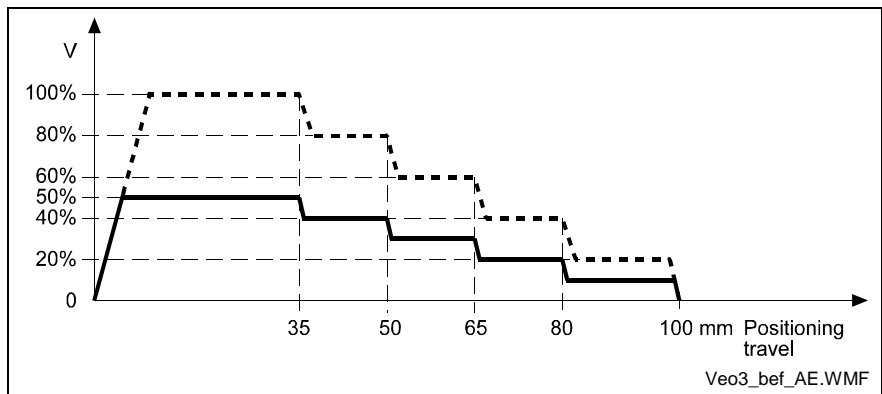

Fig. 5-29: VEO Command - Multiplication by a Factor

WAI – Wait (Time Delay)

```
WAI V600 or
WAI 00.500
```

└── Wait time in seconds

Execution of the next instruction is delayed until the programmed time has elapsed, i.e., the program proceeds to the next instruction after the waiting time has elapsed.

6 Logic Task

6.1 Tabular View

Load, Save, Set and Reset Assignments		Logical Assignments	
LD	SET	AND	XOR
LDN	SETC	ANDN	XORN
ST	RES	OR	
STN	RESC	ORN	

Timer		Other	
		NOP	

Fig. 6-1: Logic Task Commands

6.2 Load, Save, Set and Reset Assignments

Commands for Loading and Saving

LD	Loads the value of the operand
LDN	Loads the negative value of the operand
ST	Assigns the current value to the operand
STN	Assigns the bit-by-bit negated value to the operand

Allowed data type: BOOL

Set and Reset Commands

SET	Setting the bit operand, unconditional
SETC	Setting the bit operand, if the previous result is TRUE; otherwise no change
RES	Resetting the bit operand, unconditional
RESC	Resetting the bit operand, if the previous result is TRUE; otherwise no change

6.3 Logical Assignments

AND Logic

The 'AND Logic' functions bit-by-bit.

AND AND logic of the current value with the value of the operand

ANDN AND logic of the current value with the bit-by-bit negated value of the operand

Examples: AND Logic

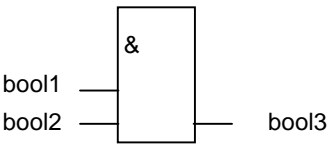
FBS		AWL	Type
		LD bool1	bool1: BOOL
		AND bool2	bool2: BOOL
		ST bool3	bool1: BOOL
bool1	1 0 1 0		
bool2	1 1 0 0		
bool3	1 0 0 0		

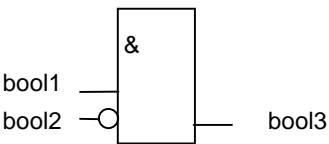
FBS		AWL	Type
		LD bool1	bool1: BOOL
		ANDN bool2	bool2: BOOL
		ST bool3	bool1: BOOL
bool1	1 0 1 0		
bool2	1 1 0 0		
bool3	0 0 1 0		

OR Logic

The 'OR Logic' functions bit-by-bit.

OR OR logic of the current value with the value of the operand

ORN OR logic of the current value with the bit-by-bit negated value of the operand

Examples: OR Logic

	FBS	AWL	Type
		LD bool1 OR bool2 ST bool3	bool1: BOOL bool2: BOOL bool1: BOOL
bool1	1 0 1 0		
bool2	1 1 0 0		
bool3	1 1 1 0		

	FBS	AWL	Type
		LD bool1 ORN bool2 ST bool3	bool1: BOOL bool2: BOOL bool1: BOOL
bool1	1 0 1 0		
bool2	1 1 0 0		
bool3	1 0 1 1		

XOR Logic

The 'XOR Logic' functions bit-by-bit.

XOR Exclusive OR logic of the current value with the value of the operand

XORN Exclusive OR logic of the current value with the bit-by-bit negated value of the operand

Examples: XOR Logic

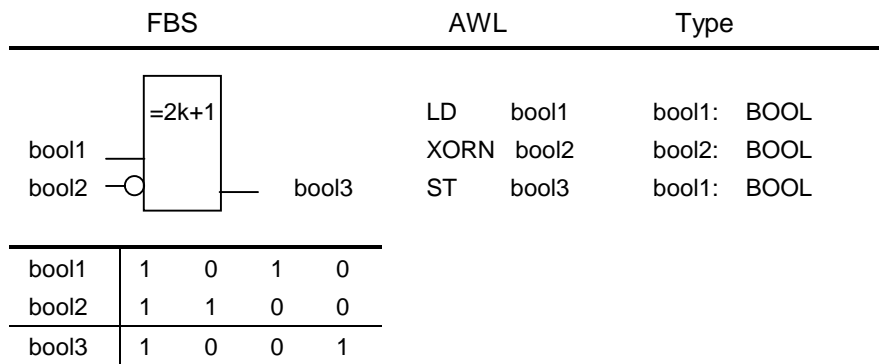
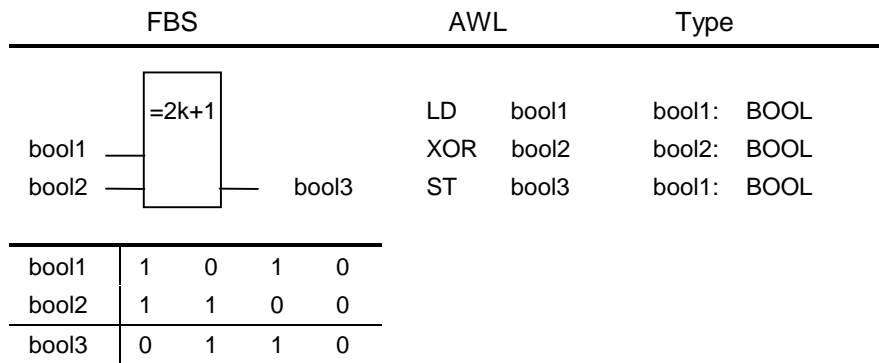

7 Functions

7.1 Operating Modes

Parameter Mode

Programming the parameters is possible only in this operating mode. When this mode is exited, the interactions between the parameters are reviewed and tested.

In Parameter Mode, the power is turned off and all tasks are halted. The outputs and non-retained marker flags are cleared.

Manual Mode

The unit is in Manual Mode when there is no error and it is not in Parameter or Automatic Mode. It is used primarily to move the axis using the Jog+ (forward) or Jog- (backward) functions.

The two tasks

- NC task 3
- Logic Task

are functioning. The following functions can also be called up.

- Homing
- Manual vector
- Interrupt
- Feed angle monitoring

Automatic Mode

In Automatic Mode, NC tasks 1, 2, 4 and 5 can be activated using the start command.

All functions are possible except for the jog and manual vector functions.

7.2 Measuring Wheel Mode

Roll-feed drives are used to feed material that is processed downstream (for example, sheet-metal cutting). The motor encoder cannot be used to measure the material length if there is slip between the material and the drive. In such cases, an optional encoder (the measuring wheel encoder) can be used. Ideally, there is no slip between this encoder and material, and the individual lengths can be measured accurately.



CAUTION

If the measuring wheel encoder has no contact with the material:

The position control circuit is open via the encoder, i.e. the motion of the drive is uncontrolled.

⇒ Start the measuring wheel mode command (automatic or manual input) only if the measuring wheel is in contact with the material.

Pertinent Parameters

- **Ax00, Application Type:**
- **Ax31, Measuring wheel operating mode.**
- **Ax16, Encoder difference monitoring**
- **C000, Encoder Data of the Master Encoder 1**
- **C001, Encoder Type of the Master Encoder 1**
- **C002, Feed Constant of the Master Encoder 1**
- **C003, Offset of Master Encoder 1**

Functioning

Repositioning is always controlled by the servo drive in Manual Mode. In Automatic Mode, repositioning is controlled by the measuring wheel encoder. If an input is defined (see Parameter Ax31), the user can switch between measuring wheel encoder and motor encoder at any time in Automatic Mode.

Repositioning by measuring wheel can be activated only if the following three conditions are met:

- The material is in feed rollers and under the measuring wheel.
- The feed rollers are closed.
- The measuring wheel encoder is pressed against the material.

If one of the previous conditions is not met, the drive can temporarily run on until it is stopped by error detection within the control. The following two error messages can be shown:

- Encoder Error
- Drive Runaway

If position loop reset is required in conjunction with 'measuring wheel mode,' the 'measuring wheel mode' signal must be removed via the signal input while resetting the position loop. Care must be taken not to exceed switching times.

For length measurements with a measuring wheel, the following two options are available:

- Option 1) The position loop is closed via the measuring wheel encoder when measuring wheel operating mode is active. The motor encoder is only used for monitoring. Disadvantage: When mechanical construction is unstable, this system is susceptible to variances.
- Option 2) The position loop is closed via the motor encoder. The position difference between the motor encoder and the measuring wheel encoder is added to the current movement as a correction. When construction is unstable, only the correction value varies. The correction is disabled as soon as the motor reaches the switching threshold defined in Parameter Ax27. The position differences that occur after disabling the correction are compiled and added to the next movement. Activation occurs via Parameter Ax00.

Note: Option 2 is not appropriate for exact positioning (depending on Parameter Ax27, Switching Threshold), because of premature disabling of the correction function.

7.3 Velocity Override

The override function permits an infinitely variable reduction in the currently programmed velocity in Manual and Automatic Modes (exception: homing using the HOM command).

Override via Analog Input

The override is controlled via the connection of current to:

AE1 (X5/11 and X5/12)

AE2 (X5/14 and X5/15)

AE3 (X7/4 and X7/5)

AE4 (X7/7 and X7/8)

The graph below shows the relationship between the applied voltage and the override factor.

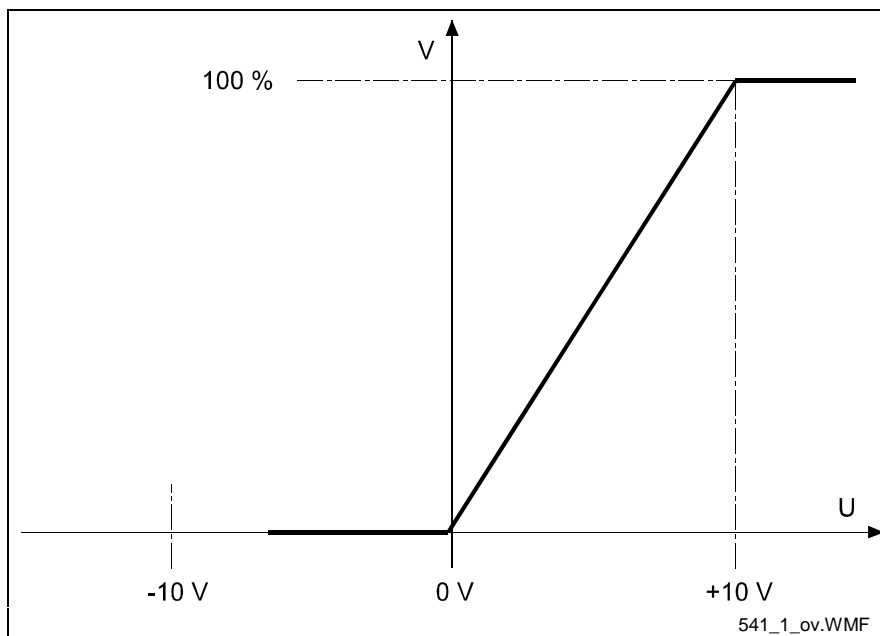

Fig. 7-1: Analog Override

The velocity 'Vo' is produced by multiplying the programmed traversing velocity 'Vp' by the override factor 'F' (F = 0 - 1 corresponds to 0V - 10V):

$$V_o = V_p \times F$$

L: V_o = velocity
 V_p = traversing velocity
 F = override factor

Fig. 7-2: Velocity Calculation with Override

This function can be activated in Parameter B017 or using the VEO command.

Override via Gray-code Inputs

The override velocity can also be set using a step switch programmed with Gray code. This switch must be connected to inputs I1.01.4 to I1.01.7. This function is activated in Parameter B017 or using the 'VEO' program command.

The set velocity always references the currently programmed velocity.

Input No.	I1.01.4	I1.01.5	I1.01.6	I1.01.7	Velocity in %
Weighted Value	2 ⁰	2 ¹	2 ²	2 ³	
	0	0	0	0	0
	1	0	0	0	1
	1	1	0	0	2
	0	1	0	0	4
	0	1	1	0	6
	1	1	1	0	8
	1	0	1	0	10
	0	0	1	0	20
	0	0	1	1	30
	1	0	1	1	40
	1	1	1	1	50
	0	1	1	1	60
	0	1	0	1	70
	1	1	0	1	80
	1	0	0	1	90
	0	0	0	1	100

Example:

The max. velocity is entered in parameter A106.

A106	000500.000
------	------------

The following program instruction is processed.

0000	PSI	1 +001000.000	500
------	-----	---------------	-----

Input I1.01.4 = weighted value of 1
 Input I1.01.5 = weighted value of 1
 Input I1.01.6 = weighted value of 0
 Input I1.01.7 = weighted value of 0

The max. velocity is 500 mm/sec.

In the sample instruction, the velocity is reduced to 50%. The result is 250 mm/sec.

If the override has also been activated in Parameter B017, the velocity is $0.02 \times 250 = 5$ mm/sec.

Override via Binary-code Inputs

The evaluation is handled via inputs I1.01.0 through I1.01.7. This function is activated separately for each axis in Parameter B017 or via the 'VEO' program command.

Input Number	:	I1.01.7							I1.01.0
binary value	:	2^7	2^6	2^5	2^4	2^3	2^2	2^1	2^0
decimal value	:	128	64	32	16	8	4	2	1

The decimal values of all of the above inputs set to 1 are added together. The resulting velocity is obtained as follows:

$$V_o = V_p \times \frac{\text{Sum of all decimal values}}{255}$$

L: V_o = Velocity
 V_p = Traversing Velocity

Fig. 7-3: Velocity Calculation

7.4 Vector Programming

Manual Vector

This makes it possible to run a user program in Manual Mode. The vector program must be concluded with an RTS command (the stack is not changed).

Note: In the manual vector program, no feeds can be programmed.

When the operating mode is changed from 'Manual' to 'Parameter,' the manual vector program is terminated. While the manual vector program is running, any attempt to change the operating mode to 'Automatic' is suppressed until the program has concluded.

The manual vector program is started by detection of the rising edge of a signal pulse at the programmed input (Parameter B014).

If '00.00.0 0 0000' is programmed in this parameter, the manual vector program is to be started only via a change in operating mode. The start instruction for the manual vector program must not be within the main program.

During jogging or homing in Manual Mode, no manual vector is accepted. No jogging or homing is possible while the manual vector program is running. Any such command is ignored.

Example: Input in Parameter B014

B014	11.01.0 0 0400
------	----------------

Input in the programming instruction

0400	AEA	Q1.00.0	0
0401	AEA	Q1.00.1	0
0402	RTS		

Outputs Q1.00.0 and Q1.00.1 are cleared when the manual vector is invoked.

Interrupt Vector

With the interrupt vector, a program running in Automatic Mode in Task 1 can be interrupted externally at any time. The program sequence then continues at the interrupt program address (Parameter B015). There is no return to the interrupted main program.

The interrupt vector can be invoked only in Automatic Mode. Therefore, the 'Start' or 'Stop' actions remain in effect. The subroutine stack (JSR, RTS) is cleared each time the interrupt vector is invoked.

Invoking the interrupt vector during a subroutine can wait until the subroutine has ended (Parameter B015).

The interrupt vector is available only in Task 1.

7.5 Multitasking

The control can process 5 cycles simultaneously (Task). The user can enter a program in each of these 5 tasks. In each task, one instruction (command) is processed within the NC cycle time.

When programming Tasks 1 through 5, take note of the following:

- The same subroutine may not be called up by more than one task at the same time!
- Movements of a given axis may not be initiated by more than one task at the same time!
- Prior to activation of Task 3, make sure that a program is present at its start instruction!

Task 1 Task 1 runs only in Automatic Mode. Program execution begins after a 'Start' and ends with a 'Stop' command. After re-entering Automatic Mode, the program counter resets to 0000 with each start command. If the start command follows execution of a prior immediate stop, the program continues from the point of interruption.

Normally, only Task 1 is in operation.

Example:

0000	AKN	M2.00.0	1
0001	PSI	1 +000100.000	999
0002	AEA	Q1.01.0	1
0003	WAI	00.250	
0004	AEA	Q1.01.0	0
0005	COU	+00000 Q1.00.0	000100
0006	JMP	0000	

Task 2 Task 2 is activated only if it has been enabled in Parameter B011. That is also where the start instruction that begins the program in Task 2 is entered for each start following re-entry into Automatic Mode.

Example: Input in Parameter B011

B011	0200 0000 0
------	-------------

Input in the programming instruction

0200	AKN	I1.00.0	1
0201	AEA	Q1.00.0	0
0202	PSI	1 +000500.000	999
0203	APE	Q1.01.0	22001112
0204	WAI	00.500	
0205	APE	Q1.01.0	22221112
0206	WAI	00.800	
0207	APE	Q1.01.0	22000002
0208	WAI	02.000	
0209	COU	+00000 Q1.00.7	000010
0210	JMP	0200	

Task 3 Task 3 is also enabled in Parameter B011, and the start instruction is defined. Program execution of Task 3 begins automatically immediately after power-up (even in Manual Mode).

Task 3 is deactivated only in Parameter Mode. Task 3 continues to run in the event of a fault or emergency stop.

Lockouts can therefore also be monitored via this cycle.

Note: Axis movements may not be processed in Task 3.

Example: Input in Parameter B011

B011	0000 0800 0
------	-------------

Input in the programming instruction

0800	AKN	I1.00.0	1
0801	APE	Q1.01.0	00000000
0802	WAI	02.000	
0803	AEA	Q1.01.0	1
0804	AKN	I1.00.00	1
0805	AEA	Q1.01.0	0
0806	AEA	Q1.01.1	1
0807	WAI	00.100	
0808	AEA	Q1.01.1	0
0809	JMP	0802	

Tasks 4 and 5 Tasks 4 and 5 are equivalent to Tasks 1 and 2. They can be enabled in Parameter B012.

Note: Tasks 1, 2, 3, 4 and 5 are equivalent. Within the NC cycle, the tasks are completed in numerical order (1, 2, 3, 4, 5).
An output set in Task 1 is processed in Task 4 as a set output.

7.6 Slave Axis

If Slave Axis Mode is enabled, the slave axis executes all movements synchronously with the master axis.

The slave axis is enabled separately for each axis in Parameter Ax00. There, the master axis is also selected.

Possible following modes for Slave Axis 1:

- 1) The master axis is Master Encoder 1

Possible following modes for Slave Axis 2:

- 2) The master axis is Master Encoder 1
- 3) The master axis is Motor Encoder Axis 1
- 4) Slave Axis 2 is assigned the same command position values as Axis 1.

If a movement is programmed for the slave axis in a later part of the program, only the slave axis is moved.

The 'FOL' command sets the ratio at which the slave axis will follow the master axis. The 'FOL' command is only effective if Slave Axis Mode is enabled.

To keep the following errors to a minimum, a following error compensation value (feedforward) can be set in Parameter Ax11.

The following conditions should be met:

- 1) If interrupt or feed angle monitoring is planned, it must be programmed for both axes. Additionally, the same input must be used for both axes.
- 2) For jogging, the jog buttons must only be used for the master axis. If the slave jog buttons are pressed, only the slave axis moves.
- 3) Possible positioning commands are POI, PSI, POA, PSA and CON.

The CLM takes into account the obvious differences between the two axes, such as encoder graduation mark, feed constants and drive sensitivity. Measuring Wheel Mode is possible for Axis 1.

The slave factor for the slave axis can be changed using the 'FOL' command.

7.7 Mechanical Data

Mechanical Transmission Elements

Mechanical transmission elements are gearboxes and feed mechanisms between the motor shaft and the load. These data must be entered in order to perform the load-side conversion of the physical parameters for position, velocity and acceleration. To see if these parameters have been entered correctly, move the shaft and compare the path followed with the position feedback value and the path actually taken.

Gear Ratio

The gear ratio can be set using the following parameters

- **Ax02, Load Gear, input revolutions**
- **Ax02, Load Gear, output revolutions**

The parameters for the ratio between gear input and output are set here.

Example:

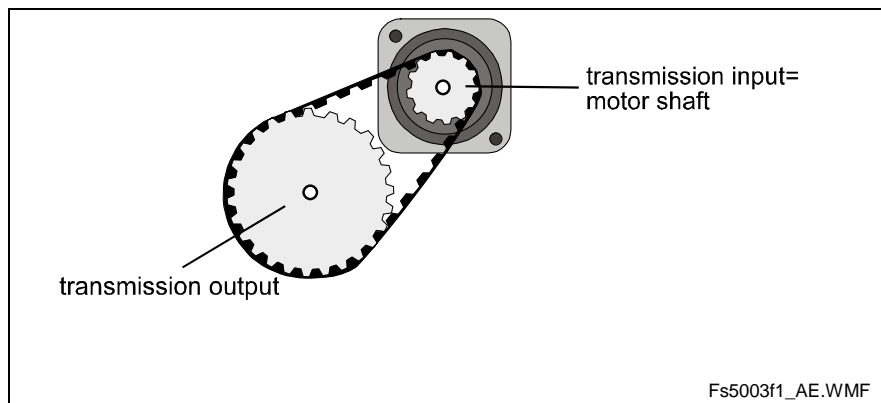

Fig. 7-4: Setting the Gear Ratio Parameters

In the illustration above, 5 gear input revolutions (= motor revolutions) were equivalent to 2 gear output revolutions. The proper parameter settings for this would be :

Input revolutions of load gear = 5

Output revolutions of load gear = 2

Feed Constant

The feed constant defines how far the load moves linearly per output revolution of the gear. It is stipulated in Parameter **Ax01, Feed constant**.

The value programmed here is used along with the gear ratio for converting the position, velocity, and acceleration data from motor reference to load reference.

Example:

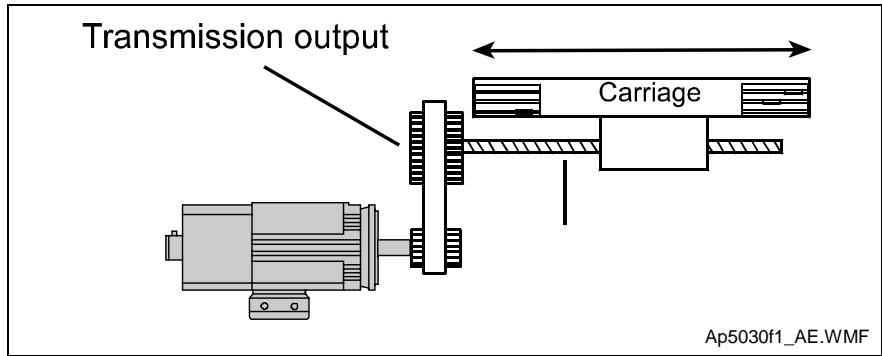

Fig. 7-5: Feed Constant Parameters

Example:

In the illustration above, the feed module would cover 10 mm per output revolution of the gear. The proper parameter settings for this would be :

Ax01, Feed constant = 10 mm/rev

Modulo Function

If Parameter Ax00 is programmed for a rotary table, the modulo function is activated and all position data in the vicinity of the 0..modulo value are displayed. Thus it is possible to implement an axis which can move infinitely in one direction. There is no overrunning of the position data.

The modulo value is set via parameter **Ax05, Modulo value**.

Note: Modulo processing of position data is allowed only in operating mode Ax00, Rotary Table. This is verified when Parameter Mode is exited, and an error message is issued if necessary.

The following illustration shows the difference in displaying the position data in absolute format and modulo format:

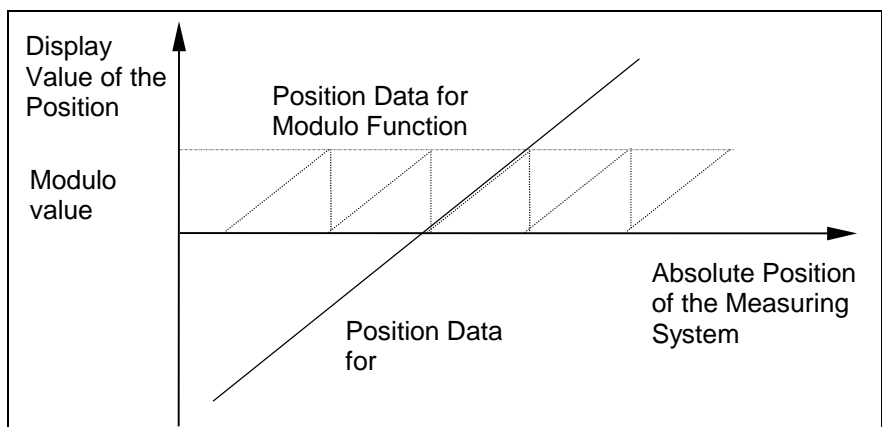

Fig. 7-6: Display Value of Positions in Absolute Format and Modulo Format

7.8 Decade Switch 'IDS01'

The decade switch 'IDS01 is designed for installation in a front panel. This decade switch can be used to input lengths in input units 'IU' and velocity values in percent into the CLM. Data transfer and power supply of the decade switch occur via a cable connection between the CLM and Connector 6 (serial interface).



CAUTION

Malfunction in the control of motors and moving elements

Risk of electric shock by touching.

⇒ Safe software and hardware design. This connector may not be connected while the unit is powered.

When using an RS232C interface, the distance between the IDS01 and the CLM may not exceed 15 meters. Use of an external power supply allows for much larger distances.

Enabling querying of the decade switch in Parameter B002 causes continuous monitoring of the decade switch transmission in Automatic Mode. If the transmission contains errors or there is no transmission, the error message 'IDS01-Break-Error' is issued.

In the program structure, the IDS01 information can be processed with variables V015 to V018.

Example:

0000	PSI	1 +V016	V018
0001	AEA	Q1.00.0	1
0002	WAI	00.500	
0003	AEA	Q1.00.0	0
0004	JMP	0000	

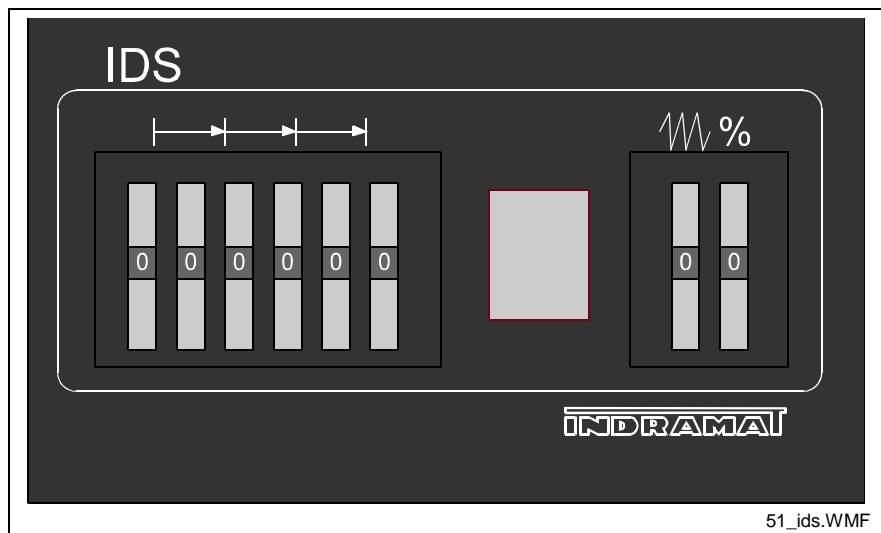

Fig. 7-7: IDS01 - Front View

The following models are available: IDS01.1-2 for programming with 2 decimal places and IDS01.1-3 for 3 decimal places.

7.9 Homing

For absolute positioning of the motor with an incremental encoder, it is necessary to establish an accurate reference point using a positioning routine (homing).

General Information

Homing is possible in 2 operating modes:

- Manual Mode - via input signal (see Parameter Ax23)
- Automatic Mode - via the 'HOM' command

There are 2 available homing options.

Option 1: Homing to home switch and marker pulse
(Parameter Ax24)

Option 2: Homing to marker pulse (without home switch)
(Parameter Ax24)

The resulting 'homing' is signaled by turning on the output programmed in Parameter Ax24.

The output is turned off by:

- re-homing
- 'Position Lag' / 'Drive Runaway' Fault
- Switching to Parameter Mode

The output can be turned off via the program; the axis remains homed.

For operation in an absolute system with an incremental encoder, all axes homed by absolute means remain homed during faults and E-Stop conditions. Detected position(s) remain, so that movements during the fault can be considered. Re-starting the CLM or exiting and re-entering Parameter Mode clears the 'homed' condition.

Note: The 'Drive Runaway' and 'Position Lag' Faults always clear the 'homed' condition.

Option 1: Homing to a Home Switch

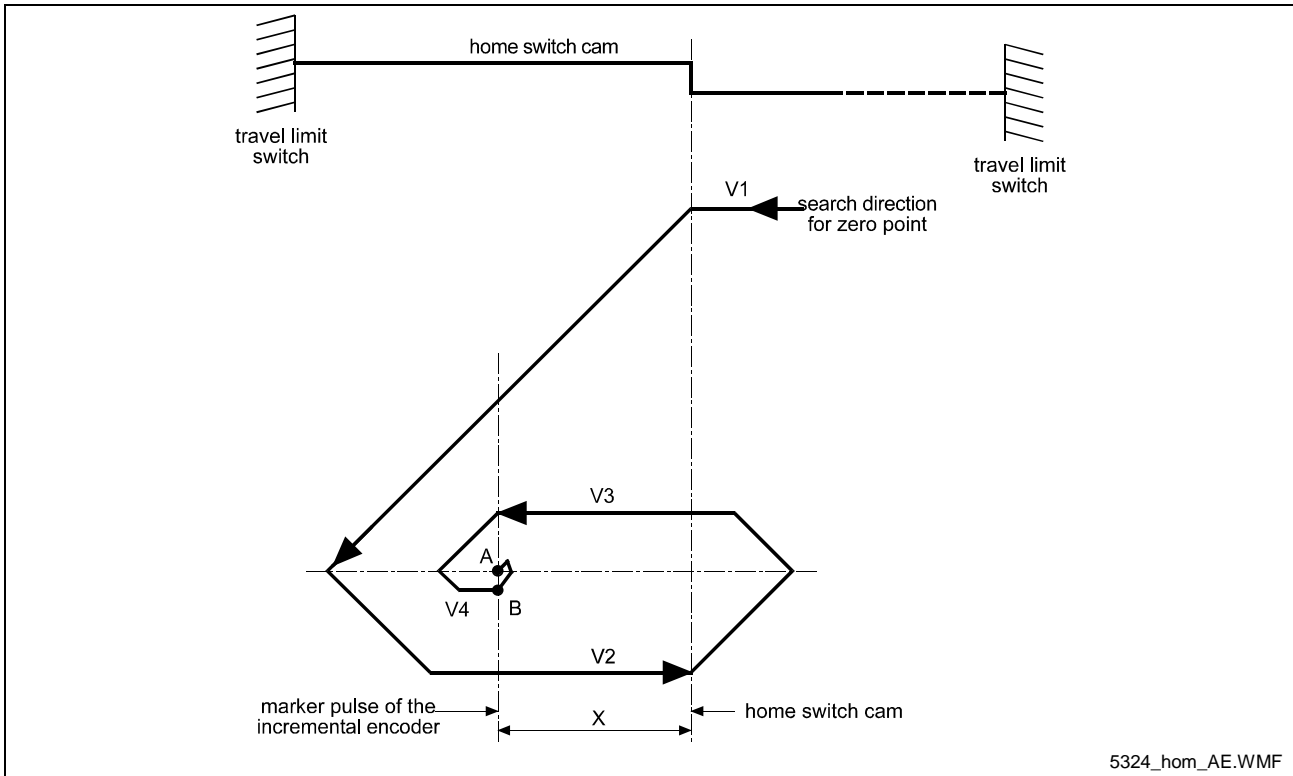

Fig. 7-8: Schematic of the Homing Routine Process

Legend

- A = Stop Position/Marker Pulse
- B = Acceptance of New Position (Norming of the Absolute Position)
- V1 = Parameter - Homing Velocity
- V2 = 25% of the Parameter - Homing Velocity
- V3 = max. 10 increments/controller cycle (system velocity)
- V4 = max. 1 increment/controller cycle (system velocity)
- X = $> 1/16$ and $< 15/16$ Feed Constant

- 1.): If the carriage is not positioned on the home switch cam, it is moved to the home switch cam using the homing velocity designated in Parameter Ax24.
- 2.): As soon as the cam switch is activated, the carriage reverses and moves off the cam using 1/4 of the Parameter Homing Velocity. After leaving the cam, the carriage is reversed again and moved to the cam at 10 increments per controller cycle (see Parameter B010), until the first marker pulse from the incremental encoder has been evaluated. Now the carriage is reversed again, and moved to the exact position of the marker pulse (± 1 increment) at 1 increment per controller cycle.

- 3.): If the carriage is positioned on the cam when the homing routine is initialized, it is moved off the cam at 1/4 the velocity designated in the parameter. Then, the same process as described in 2.) is followed.

Placement of the Home Switch

As described above, the zero position of the AC servo drive is determined by contact with the home switch cam. The zero position can also be set in increments of one motor revolution each through the activation position of the switch.

The CLM diagnostics ensure that the home switch and the marker pulse cannot be too close together, by monitoring their switching points. This eliminates instability in the evaluation of the motor revolution because of switching tolerances.

If the switching point of the home switch is closer than 1/16 motor revolution to the marker pulse, the control does not complete the homing routine but enters fault mode with the error message 'Marker Pulse.'

The home switch must be moved by 1/3 of the feed constant.

Activation of the Home Switch

Activating the home switch must occur so that the switch is completely closed by reverse motion (movement away from the workpiece).

The cam for activating the home switch must be long enough to ensure that the activation will not be cancelled while completing the reverse motion to the travel limit switch of the unit. This is necessary to indicate to the control the direction the carriage must travel to approach the zero position.

Because the relationship between the turning direction of the servo motor and the movement from and to the workpiece is dependent upon machine construction, the homing direction must be set in a parameter. If no marker pulse is detected from the encoder within one encoder revolution, the CLM enters fault mode with the error message 'No Marker Pulse.'

Termination of the Homing Routine

If a stop, interrupt, feed monitoring or mode change command is received in Manual Mode, the cycle is terminated and must be reinvoked.

In Automatic Mode, the homing routine restarts immediately after the interrupt or stop is cleared and the start button is pressed.

Following an error or a change in operating mode during the homing routine, the homing routine must be reinvoked.

Option 2: Homing without a Home Switch

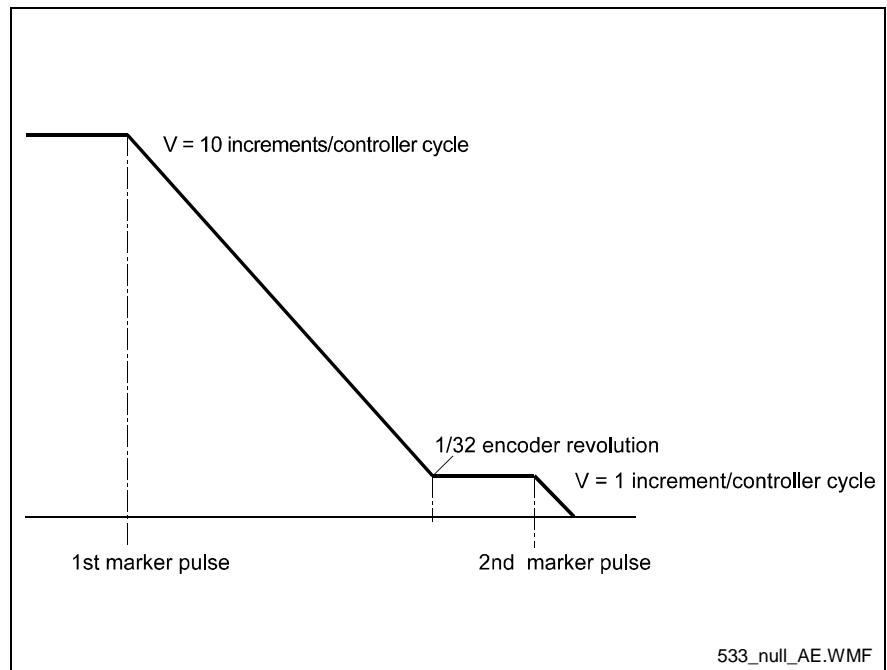

Fig. 7-9: Homing

The first marker pulse is searched for at 10 increments/controller cycle. If it is found, a positioning move in the same direction occurs, to a position 1/32 revolution before the second marker pulse. After reaching this position, the second marker pulse is searched for at 1 increment/controller cycle.

The input unit is defined in Parameter Ax24.

A possible application is a spindle drive with a pre-designated turning direction.

7.10 Position Loop Reset (Electrical Release)

The function 'Position Loop Reset' is activated by programming an input in Parameter Ax30. If it contains '00.00.0,' this function is not programmed.

By placing 24V at the input 'Position Loop Reset,' the function is activated.

In addition, an output must be programmed. This output is powered when the drive is in position. At the same time, a command value of 'Null' is issued. Then, it is possible that the drive may drift.

The function 'Position Loop Reset' is available for Axes 1 to 4, independently.

Also refer to the description for Parameter Ax30.

During the position loop reset, when a feed instruction is encountered, motion and proceeding to the next instruction are delayed until the input becomes '0.'

Example:

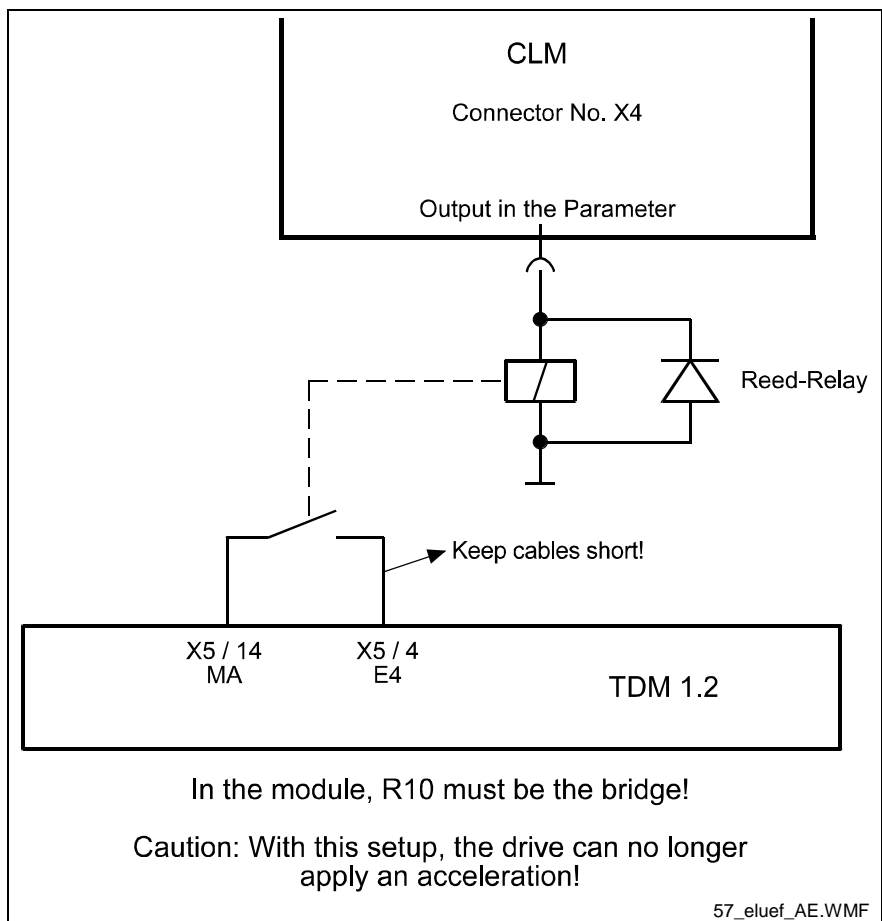

Fig. 7-10: Electrical Release

7.11 Restart

The Restart function continues a program interrupted by a loss of power, an error message or a switch from Automatic to Manual Mode.

Restart is only possible following one of the situations mentioned above.

The condition is that a program was running in Automatic Mode.

For each of these situations, the current status of Task 1, 2, 4 and 5 (feedrate, absolute target position, status of the outputs, etc.) is saved temporarily.

A Restart is initiated by a rising signal edge (jump from 0V to +24V) at the system input 'Re-Start' (CLM connector X3 / pin 15) in Automatic Mode.

If no Restart is possible at the time, this input has the same functionality as the system input 'Start.'

The functionality of this input can be determined by considering the status of the output described below.

Restart is not possible when, for example:

- a) power loss, error or E-Stop occurred during a program stop or in Manual Mode.
- b) the error message 'Position Lag' or 'Drive Runaway' was issued during position evaluation with an incremental encoder.

The system output 'Restart possible' (CLM connector X4 / pin 9) indicates whether or not a Restart can be executed.

Output set to:	0 Volts	=	no Restart possible
	+24 Volts	=	Restart possible

With a Restart program, the Restart process can be controlled.

It can be activated by inputting a Start instruction for the Restart program in Parameter B016.

When the parameters are set, this program is called by a rising edge at the 'Re-Start' input. The actual Restart process is not initiated until the end of the program.

The 'RSV' command affects the execution of the Restart program. It allows selective restoration of the interrupted program's status.

The Restart program ends with another 'RSV' command.

See also descriptions of the 'RSV' command and Parameter B016.

Notes

8 Parameters

8	PARAMETERS.....	8-1
8.1	GENERAL INFORMATION	8-3
8.1	SYSTEM PARAMETERS	8-5
	<i>Ax00</i> Axis x Mode.....	8-5
	<i>Ax01</i> Axis x Feed Constant.....	8-6
	<i>Ax02</i> Gear.....	8-7
	<i>Ax03</i> Axis x Minimum Travel Limit Value	8-7
	<i>Ax04</i> Axis x Maximum Travel Limit Value	8-9
	<i>Ax05</i> Axis x Modulo Value.....	8-10
	<i>Ax06</i> Axis x Maximum Velocity.....	8-11
	<i>Ax07</i> Axis x Jog Velocity.....	8-11
	<i>Ax08</i> Axis x Acceleration Rate.....	8-12
	<i>Ax09</i> Acceleration / Deceleration Rate.....	8-12
	<i>Ax10</i> Jerk Constant.....	8-13
	<i>Ax11</i> Axis x Kv Factor	8-14
	<i>Ax12</i> Axis x Drive Sensitivity.....	8-15
	<i>Ax13</i> Reserved (Free).....	8-16
	<i>Ax14</i> Axis x Position Monitoring Window.....	8-16
	<i>Ax15</i> Feed Angle Monitoring / Interrupt	8-18
	<i>Ax16</i> Axis x Encoder Difference.....	8-19
	<i>Ax17</i> Axis x Absolute Encoder Monitoring Window.....	8-19
	<i>Ax18</i> Reserved (Free).....	8-19
	<i>Ax19</i> Axis x Encoder Data.....	8-20
	<i>Ax20</i> Axis x Encoder Type	8-20
	<i>Ax21</i> Axis x Drive Direction.....	8-21
	<i>Ax22</i> Axis x Absolute Encoder Home Position.....	8-21
	<i>Ax23</i> Axis x Homing I/O.....	8-22
	<i>Ax24</i> Axis x Homing Search Distance	8-22
	<i>Ax25</i> Axis x Homing Offset.....	8-23
	<i>Ax26</i> Reserved.....	8-23
	<i>Ax27</i> Axis x Switching Threshold.....	8-23
	<i>Ax28</i> Position Window.....	8-24
	<i>Ax29</i> Axis x Presignaling.....	8-24
	<i>Ax30</i> Axis x Open Feed Roll.....	8-24
	<i>Ax31</i> Axis x Measuring Wheel Mode	8-25
	<i>Ax32</i> Axis x Various Functions.....	8-25
	<i>Ax33</i> Axis x Cut Inhibit	8-25
	<i>Ax34</i> Axis x Cut Vector	8-26
8.1	GENERAL PARAMETERS	8-27
	<i>B000</i> Enable Axis.....	8-27
	<i>B001</i> Display.....	8-27
	<i>B002</i> RS Interface Format X6	8-28
	<i>B003</i> RS Interface Functions X6.....	8-29
	<i>B004</i> RS Interface Format X8.....	8-29
	<i>B005</i> RS Interface Functions X8.....	8-29
	<i>B006</i> Fieldbus Time Monitoring	8-30
	<i>B007</i> Fieldbus Baudrate.....	8-30
	<i>B008</i> Fieldbus Formats	8-31
	<i>B009</i> Reserved (Free).....	8-31
	<i>B010</i> Cycle Time	8-32
	<i>B011</i> Start Program Instruction - Task 2, Task 3.....	8-32
	<i>B012</i> Start Program Instruction - Task 4, Task 5.....	8-33
	<i>B013</i> Logic Task.....	8-33
	<i>B014</i> Manual Vector.....	8-33
	<i>B015</i> Interrupt Vector.....	8-34
	<i>B016</i> Re-Start Vector.....	8-34
	<i>B017</i> Analog Input / Override.....	8-35

<i>B018</i>	<i>Clear Outputs</i>	8-36
<i>B019</i>	<i>Memory Display</i>	8-40
8.1	MASTER ENCODER PARAMETERS.....	8-41
<i>C000</i>	<i>Master Encoder 1, Measuring Wheel Encoder Data</i>	8-41
<i>C001</i>	<i>Master Encoder 1, Measuring Wheel Encoder Type</i>	8-41
<i>C002</i>	<i>Master Encoder 1, Measuring Wheel Encoder Feed Constant (VK)..</i>	8-42
<i>C003</i>	<i>Master Encoder 1, Measuring Wheel Offset</i>	8-42
<i>C004</i>	<i>Master Encoder 2, Measuring Wheel Encoder Data</i>	8-42
<i>C005</i>	<i>Master Encoder 2, Measuring Wheel Encoder Type</i>	8-42
<i>C006</i>	<i>Master Encoder 2, Measuring Wheel Encoder Feed Constant (VK)..</i>	8-42
<i>C007</i>	<i>Master Encoder 2, Measuring Wheel Offset</i>	8-42
8.5	LIST OF CLM PARAMETERS	8-43
8.6	MINIMUM AND MAXIMUM VALUES FOR PARAMETER INPUT	8-46

8.1 General Information

The parameters and the user program are stored on a module card. This card has the description 'MOK19.'

Note: This data can be lost in the event of an error. Therefore, it is critically important to back up this data in another place outside the control. (e.g.: external computer or as a hard copy)

All system rating data and mechanical details are input into the CLM as parameters.

Parameters are input in Parameter Mode. For most parameter numbers, only one piece of information can be stored.

The parameters and user program are protected from power loss.

After start-up, pressing the 'Clear' key for faults, or loading parameters, the parameters are checked. For erroneous or missing parameters, an corresponding error message (Invalid Input) is issued.

When parameters are changed, a recalculation of all parameter-dependent program instructions is performed when exiting Parameter Input mode. During this time, the message 'Please Wait' appears on the display.

Note: The parameter data is transferred to the memory using the Save key .

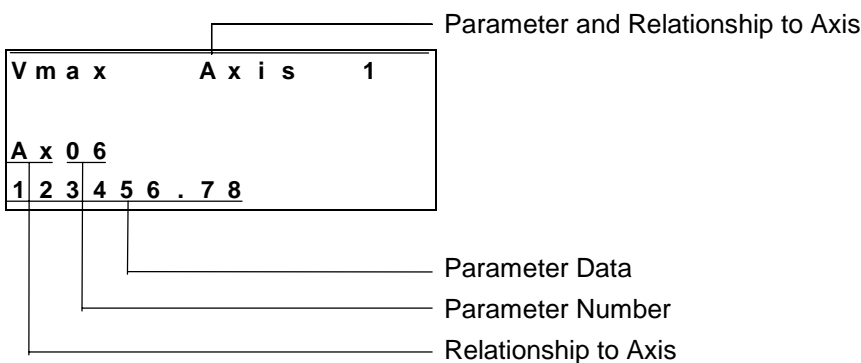

In the first display line, the parameter description with the corresponding relationship to the axis is always displayed.

In the third display line, the relationship to the axis and the parameter number is displayed.

In the fourth display line, the parameter data is displayed.

The unit designation 'IU' that is used in the parameter descriptions means that an input in 'input units' is required.

Parameter Mode The parameters are organized in 6 groups. The first group is the general parameters. The next four groups are assigned to Axes 1 to 4. The data structure is identical for all four axes. In the last group, the parameters are for the additional encoders, e.g. measuring wheel.

The parameter identification is comprised of a block identifier and the actual (two-digit) parameter number.

Parameter Instruction	Group Designation	Parameter Number
General Parameters	B0	00 to 19
Axis 1 Parameters	A1	00 to 34
Axis 2 Parameters	A2	00 to 34
Axis 3 Parameters	A3	00 to 34
Axis 4 Parameters	A4	00 to 34
Encoder Parameters	C0	00 to 07

The CLM functions at least with Axis 1, which means that parameter sets B0xx, C0xx and A1xx must be programmed in any case.

The inputs and outputs listed in the parameter description, as well as all input values shown are only examples.





Note: Double assignment of inputs and outputs results in malfunctions and must be avoided.



Parameter Input To store a parameter, the Store key  must be pressed.



A validity check of the parameters is performed after leaving Parameter Mode. Erroneous parameters are displayed and must be corrected.

When entering Parameter Mode, Parameter A100 is displayed. The cursor is placed on the tens digit of the parameter number.

Repeatedly pressing  places the cursor to the left on the first digit of the parameter data or on the tens digit of the parameter number.

Repeatedly pressing  or  places the cursor on the tens digit of the parameter number. Each press of  or  switches to the next parameter block (from B000 to A100, A200, A300, A400 and C000). The blocks for the axes that do not have set parameters (see B000) are skipped and not shown.

The individual parameters can be selected in Parameter Mode by directly inputting the parameter number or scrolling using  and .

Using  and , the cursor can be placed on the parameters. There, the new parameter number can be input directly using the numbered keys.

After storing a parameter, the next parameter is shown.

8.2 System Parameters

Ax00 Axis x Mode

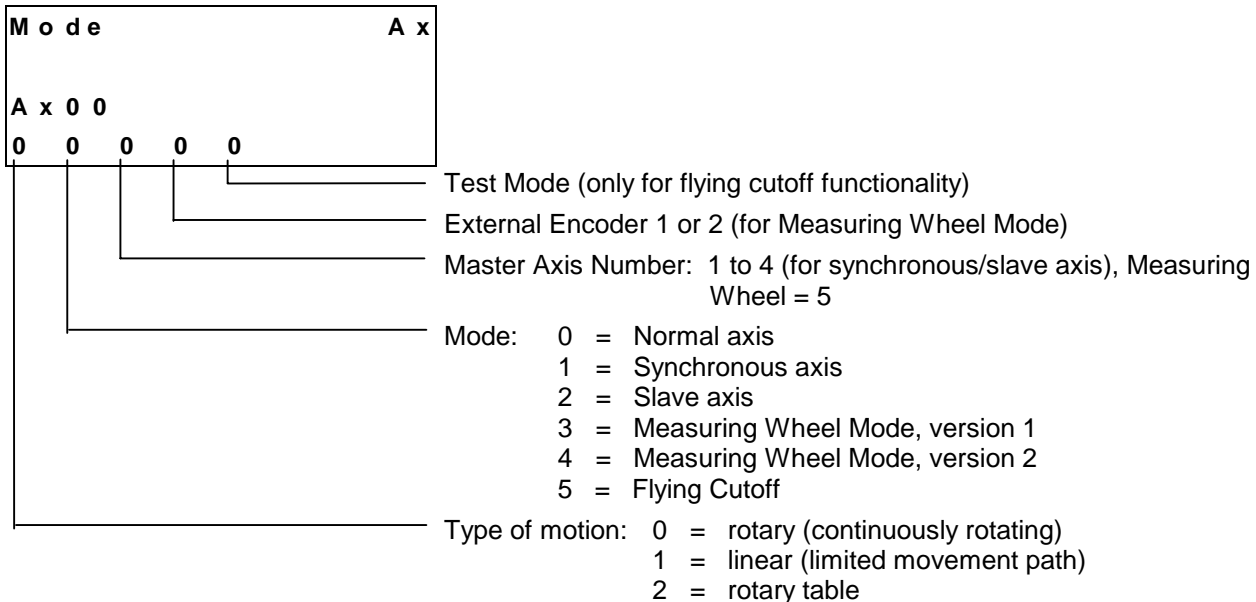

Type of motion: With **rotary** motion, the drive unit normally turns continuously in one direction. The product is brought to its relative position using rollers and is then processed. Roll feed mechanisms are typically used. There are no travel limit switches.

With **linear** motion, the drive unit moves a mechanical system only a specified distance. Normally, absolute positioning is performed and travel limit switches monitor the distance traversed.

The **rotary table** normally turns continuously.

Positioning is absolute within one revolution (modulo value). There are no travel limit switches.

Mode:

- 0** = No second encoder is available
- 1** = Synchronous axis: This axis executes the same movements as the master axis, without phase adjustment.
- 2** = Slave axis: This axis follows the actual position of the master axis. An evaluation of the actual impulses for the master axis is possible using the FOL command.
- 3** = Using this function, at times an external encoder detects the position. It is possible to switch back and forth between the motor encoder and the measuring wheel encoder. Only relative distances are traversed.
- 4** = Measuring wheel operating mode: The actual values of the motor encoder and the measuring wheel encoder are compared and the travel distance is corrected by the difference.

Ax01 Axis x Feed Constant

F	e	e		C	o	n	s	t	a	n	t		A	x
A	x	0	1											
0	0	5	0	.	0	0	0	0	0	0				

Feed constant in IU

Note: This is where the IU is defined

IU = Input Unit

This parameter describes the conversion from rotary to linear motion. It is defined as the linear displacement of the load during one revolution of the gear drive shaft.

Input can be in any desired dimension (e.g. mm, cm, m, inch, degrees, etc. and is referred to below as the input unit (IU).

It is important that all other measurements entered be referenced to this same unit.

The input has five decimal places.

Input range: from 0.01000 to 5000.00000 in IU

Note: For rotary table programming using an incremental encoder, the unit per table revolution is set in Parameter Ax01, e.g.: Ax01 = 0360.00000 corresponds to 360° per table revolution
The gear ratio is defined in Parameter Ax02.

Ax02 Gear

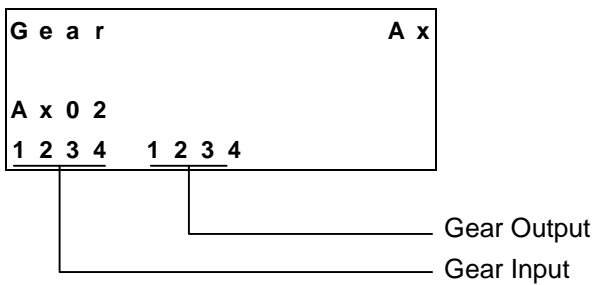

A mechanical gear is often employed between the motor and the load. This parameter defines the gear ratio of the motor shaft to the output gear shaft for rotary applications with incremental encoders.

The **gear ratio** is defined as:

$$i = \frac{\text{Input revolutions of load gear}}{\text{Output revolutions of load gear}}$$

Fig. 8-1: Gear Ratio

See also functional description for: "Gear Ratio" and "Modulo Function"

Example:

5 turns of the motor shaft produce 2 turns of the output gear shaft.

⇒ Input revolutions: 5
 Output revolutions: 2

Input min.: 1
 Input max.: 9999

Note: This function is valid only when rotary table with incremental encoder is selected.

Ax03 Axis x Minimum Travel Limit Value

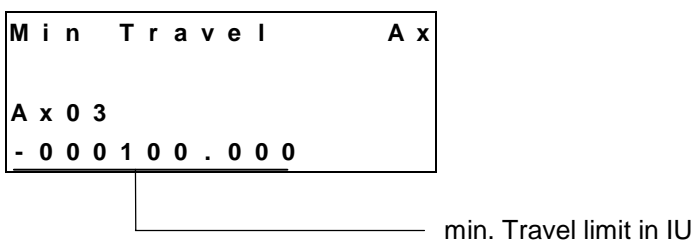

Here, the minimum allowable travel limit value is input. The limit is available only in Absolute Mode.

In Manual Mode, the corresponding jog key becomes inactive when this position is reached. If the actual position is smaller than this limit value in Automatic Mode, **error message 46, 76, A6, D6** is generated.

The travel range value is measured from the home position and is not calculated using the offset dimension Ax25.

If a target position beyond the negative travel limit is stipulated for the drive, **error message 50, 80, B0, E0** is generated.

Example, when using an incremental encoder:

When using an incremental encoder, depending upon programming, the home position shifts forward or backward from the home switch. The minimum value is always input as a negative value.

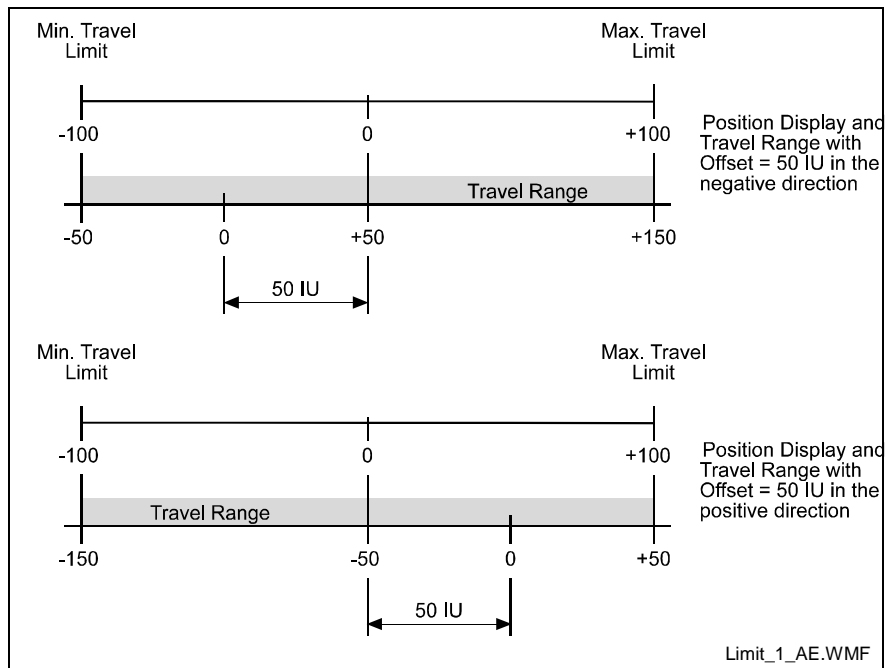

Fig. 8-2: Minimum Travel Range with Incremental Encoder

Example, when using an absolute encoder:

For absolute encoders, the home position always shifts in the positive direction from the encoder home position. The minimum value is always input as a positive value.

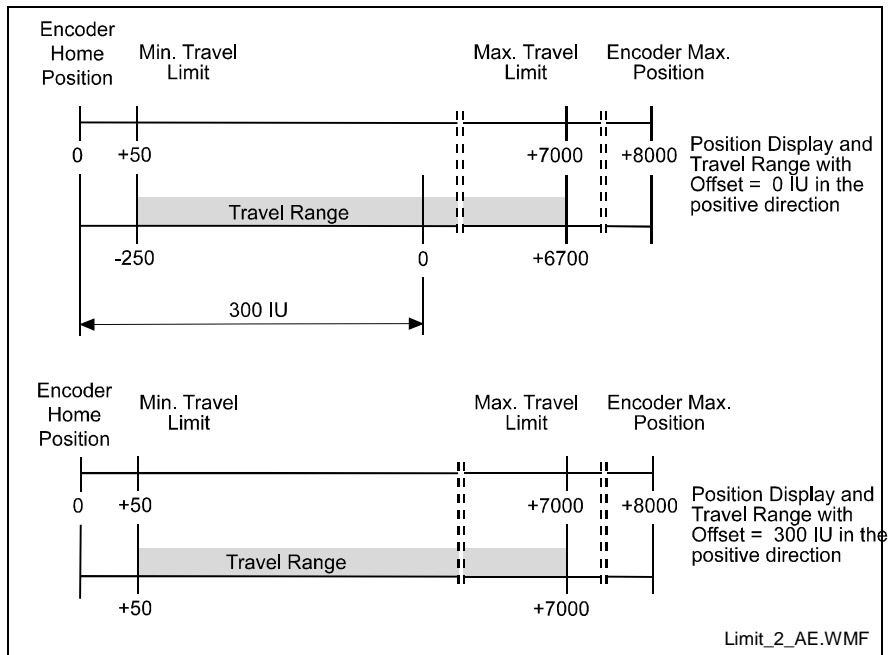

Fig. 8-3: Minimum Travel Range with Absolute Encoder

Ax04 Axis x Maximum Travel Limit Value

```

Max Travel Ax
Ax04
+ 0 1 2 3 4 5 . 7 8 9
    
```

Max. travel limit in IU

Here, the maximum allowable travel limit value is input. The limit is available only in Absolute Mode.

In Manual Mode, the corresponding jog key becomes inactive when this position is reached. If the actual position is larger than this limit value in Automatic Mode, **error message 47, 77, A7, D7** is generated:

The travel range value is measured from the home position and is not calculated using the offset dimension Ax25.

If a target position beyond the positive travel limit is stipulated for the drive, **error message 51, 81, B1, E1** is generated.

The maximum value is always input as a positive value.

Ax05 Axis x Modulo Value

M	o	d	u	l	o	V	a	l	u	e	A	x
A	x	0	5									
0	1	2	3	4	5	.	7	8	9		0	

0 = programmed direction (for rotary table)

1 = shortest path

modulo value (in preparation)

When the modulo format is set, the modulo value determines the numeric value at which the position data overflow to 0.

This parameter is used only with motion type 2 (rotary table, **Parameter Ax00**) and normally indicates the circumference of the table.

Input min.: 0.000 IU

Input max.: 200000.000 IU

Ax06 Axis x Maximum Velocity

```

max . Velocity Ax
Ax06
1 2 3 4 5 6 . 7 8 9

```

Maximum velocity in IU/sec

The maximum velocity input here is the highest velocity to be used for travel.

The maximum velocity may not be larger than the maximum possible velocity, which is calculated as follows:

$$V_{\text{max possible}} = \frac{\text{Rpm}(P. Ax12)}{60} \times \text{Feed constant}$$

L: Vmax = Maximum velocity
Rpm = Revolutions per minute

Fig. 8-4: Axis x Maximum Velocity

If the velocity is larger than 'Vmax possible,' the error message 'Invalid Input' is shown on the display.

Input range: from 0.100 to 50000.000 in IU/sec

Ax07 Axis x Jog Velocity

```

man . Velocity Ax
Ax07
0 0 0 1 6 6 . 6 6 6

```

Velocity in Manual Mode in IU/sec

With the velocity entered here, the drive is moved using 'Jog forward' or 'Jog reverse.'

Input range: from 0.100 to 50000.000 in IU/sec

also: Ax07 <= Ax06

Ax08 Axis x Acceleration Rate

A c c e l	R a t e	A x
A x 0 8		
0 0 0 1 0 0		

Acceleration in IU/sec²

The drive accelerates with the value set here. A different deceleration value can be programmed in Parameter Ax09.

Input range: from 1 to 999999 in IU/sec²

Ax09 Acceleration / Deceleration Rate

A c c e l / D e c e l	A x
A x 0 9	
1 2 3 1 2 3	

Deceleration in ‰ of Ax08

Acceleration in ‰ of Ax08

If the value 000 is input, the value in Parameter Ax08 is valid.

Ax10 Jerk Constant

```

J e r k   C o n s t a n t   A x
A x 1 0
0 . 2 3 4
    
```

Time constant for acceleration change (sec)
 Input range: 0.000 to 1.024
 0 = Jerk limiting inactive, constant acceleration

The 'Time Constant for Acceleration' sets the time during which the CLM accelerates. Internally, the CLM rounds the time constant up.

$$\frac{\text{Jerk Constant (s)} \times 1000}{\text{Position Loop Cycle Time (ms)}} = 2^n$$

Fig. 8-5: Calculation of the Time Constant

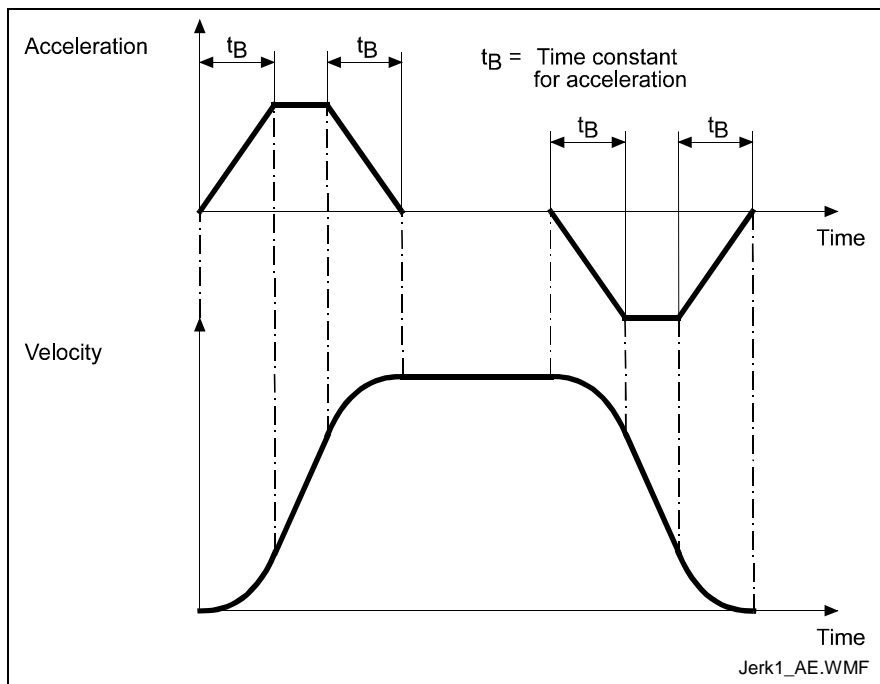

Fig. 8-6: Jerk Limiting

Ax11 Axis x Kv Factor

K v	F a c t o r	A x
A x 1 1		
0 1 . 2 3	0	

Feedforward

0 = off

1 = on

1 = on + with interim values for command pulses

2 = Average of 2 values

3 = Average of 4 values

4 = Average of 8 values

5 = Average of 16 values

6 = Average of 32 values

7 = Average of 64 values

8 = Average of 128 values

9 = Average of 256 values

Kv Factor

Feedforward can only be turned on for 'Flying Cutoff' or 'Slave Axis.'

With the Kv Factor, the position gain is defined. The Kv Factor determines the position lag that would be calculated at maximum velocity.

Kv = 1 produces a position lag of 1 mm at a velocity of 1 m/min.

Input range: from 0.01 to 20.00

The Kv factor must be matched to the given mechanical conditions.

A Kv Factor that is too small reduces drive dynamics.

A Kv Factor that is too large causes the drive to become unstable.

To determine the optimal value, begin with Kv = 1.00.

Ax12 Axis x Drive Sensitivity

D r i v e S e n s i t i v A x
A x 1 2
0 1 0 0 0 0 9 . 0

Command voltage at maximum velocity in volts, with 1 decimal place (00.5 to 10.0)

Max. encoder velocity in Rpm (0001 to 9999)

The maximum velocity Ax06 is calculated as follows:

$$V_{\max} = \frac{\text{Rpm}}{60} \times \text{Feed Constant}$$

Fig. 8-7: Maximum Velocity

For drive amplifiers with analog inputs ≤ 10 V that limit the velocity command value, the drive amplifier and the CLM should be calibrated at 9 V to ensure sufficient system resources at maximum velocity.

Ax13 Reserved (Free)

Free	Axis
Ax13	

Ax14 Axis x Position Monitoring Window

Monitor Wind.	Axis
Ax14	
0 1 2 3	Q1.00.0

Output 'Position error > Max. allowable difference'

This output is set when the position difference is greater than the allowed difference. An input of 00.00.0 means no output programmed. The output programmed here is set only when the error message is deactivated. The error message can be deactivated by inputting 1 as the first character in Parameter Ax14.

Maximum allowable position difference in percent of the maximum position difference (position lag). Normally, a value of 10-20 % is to be entered here.

Input range: from 001 to 100

0 = Error messages 'Drive Runaway,' 'Position Lag,' 'Encoder Error' are active

1 = Error messages deactivated

The CLM constantly monitors the position of Axis x. The CLM uses a mathematical model of the system to calculate the expected position error.

'Drive Runaway' is present when the current position of the encoder exceeds the command position of the motor.

'Position Lag' is present when the current position of the encoder is less than the expected position of the motor.

'Drive Runaway' and 'Position Lag' lead to a corresponding error message.

The maximum allowable difference between the actual position and the position calculated in the motor is set in Parameter Ax14 in %.

The maximum position difference is calculated as follows:

$$\text{Position Difference in IU} = \frac{\text{max. velocity in IU/sec}}{Kv} \times \frac{60}{1000}$$

$$\pm \text{Max. Position Difference in IU} = \frac{\text{Velocity (as in Ax12)} \times \text{VK (as in Ax01)}}{Kv \text{ Factor (as in Ax11)} \times 1000}$$

L: IU = Input Units
 Kv = Factor Value / Parameter Ax11
 VK = Feed Constant / Parameter Ax01

Fig. 8-8: Position Monitoring

Example:

IU = mm
 Maximum velocity (Ax21) = 2000 Rpm
 VK (Ax01) = 100 mm
 Kv (Ax11) = 1

$$\pm \text{Max. Pos. Difference in IU} = \frac{2000 \text{ Rpm} \times 100 \text{ mm}}{1 \times 1000} = 200 \text{ mm}$$

Fig. 8-9: Example of Position Monitoring

With a change to the parameters 'Kv Factor' and 'Maximum Velocity,' because the input is in percent, the monitoring window does not need to be reprogrammed.

So that the correct error message is always issued, Parameter Ax27 (Switching Threshold) should be smaller than:

$$\frac{\text{Parameter Ax14 in \%}}{100} = \text{max. Position Difference}$$

Fig. 8-10: Calculation of the Switching Threshold

If Parameter Ax14 is programmed as too small a value, even a normal movement generates a 'Drive Runaway' or 'Position Lag' fault.

Example for 'Drive Runaway':

- 1) Parameter Ax21 'Direction' conflicts with the encoder wiring or the command value.
- 2) The axis moves without the output of a command position.
- 3) The input value in Parameter Ax19 does not correspond with the encoder data (too small).
- 4) The maximum velocity in Parameter Ax12 is smaller than the indication on the amplifier module.

Example for 'Position Lag':

- 1) The programmed positioning command is not executed (no movement) because:
 - a) the encoder cable is not connected
 - b) the encoder cable is not defective
- 2) The input value in Parameter Ax19 does not correspond with the encoder data (too large).
- 3) The maximum velocity in Parameter Ax12 is larger than the indication on the amplifier module.
- 4) The acceleration is too large.
- 5) The signal 'Controller Enable' from the CLM does not reach the drive.
- 6) The value selected in Parameter Ax14 is too small.

Ax15 Feed Angle Monitoring / Interrupt

Feed	Angle	Mon	Axis
Ax 1 5			
1	1	0	0
0	0	1	1

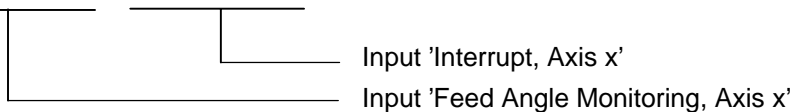

1) Feed angle monitoring

Whether or not the feed is to be monitored is entered here.

With an input of '00.00.0,' the axis is not monitored.

If no signal is present at the specified input, no feed takes place. The CLM processes all instructions that do not contain a feed length. As soon as the program encounters an instruction containing a feed distance, the CLM stops at this instruction until a signal is applied at the input. If the signal drops out during feed, an error message is issued.

This function is enabled in Manual and Automatic Mode.

2) Interrupt

Whether or not it is possible to interrupt the current feed is entered here.

With an input of '00.00.0,' no interrupt monitoring occurs. If the signal at the specified input is lost, any initiated positioning functions are not executed, or those already in progress are stopped. All instructions containing no feed distances continue to be processed as usual. As soon as the program encounters an instruction containing a feed distance, the CLM stops at this instruction until a signal is applied at the input.

If any other operating condition is retained, execution or continuation of the positioning function takes place as soon as the signal is present or when it reoccurs.

This function is enabled in Manual and Automatic Mode.

Ax16 Axis x Encoder Difference

E n c . D i f f e r e n c e A x A x 1 6 1 2
--

Monitoring window in % (only for Measuring Wheel Mode)

Ax17 Axis x Absolute Encoder Monitoring Window

A b s . M o n i t o r i n g A x A x 1 7 1 2 3 4 . 5 6 7
--

Absolute encoder monitoring window in IU
In preparation

Ax18 Reserved (Free)

F r e e	A x
A x 1 8	

Ax19 Axis x Encoder Data

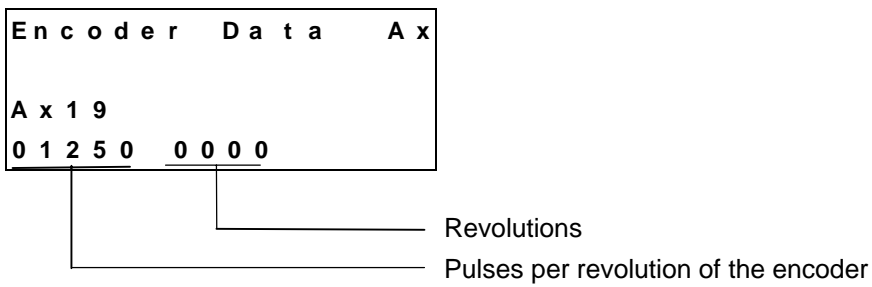

Here, the number of pulses per encoder revolution is input.

If an incremental encoder is used, the input of revolutions is meaningless.

Input range: from 100 to 5000

Ax20 Axis x Encoder Type

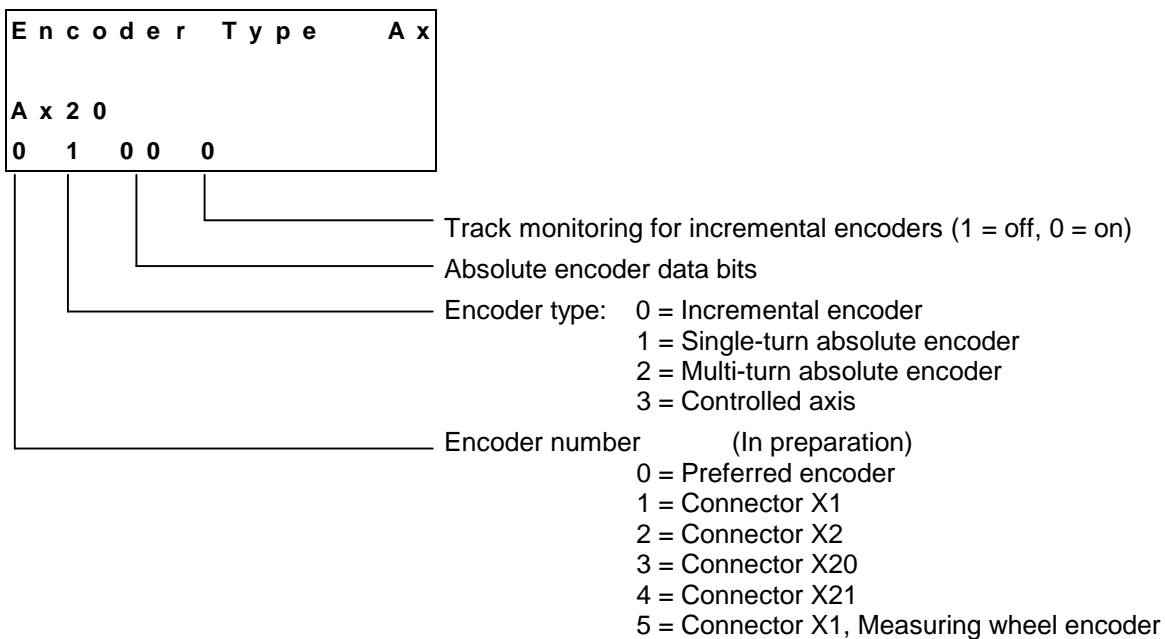

Ax21 Axis x Drive Direction

D i r e c t i o n			A x
A x 2 1			
0	0	0	

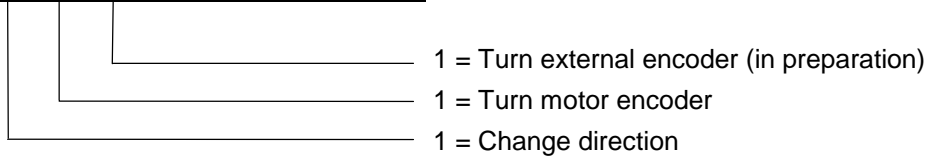

Designated directions can be mixed (combined).

Ax22 Axis x Absolute Encoder Home Position

In preparation

A b s . E n c . H o m P o s A x										
A x 2 2										
0	0	+	1	2	3	4	5	6	.	7 8 9

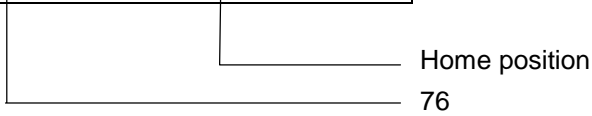

Ax23 Axis x Homing I/O

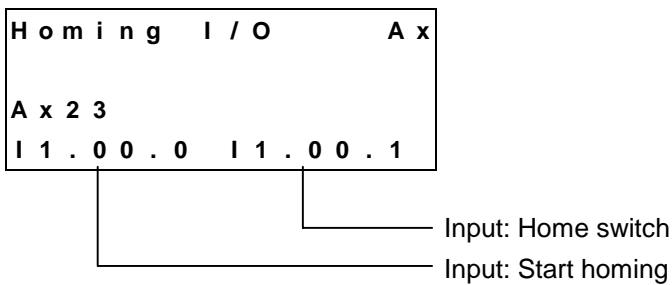

Home Switch:

- I1.xx.x = Input: Home switch for homing
 'HOM' - Option 1
 00.00.0 = Input: Homing without home switch, only to
 Marker pulse, 'HOM' Option 2

Start Homing Command:

- I1.xx.x = Input, Homing in Manual Mode
 00.00.0 = no input selected (homing is only possible using the
 'HOM' command)

With a rising signal edge at the command input, the homing cycle is started. The home position can be targeted in Manual Mode via the command input or in Automatic Mode via the 'HOM' command.

For further information, see 'Homing.'

Ax24 Axis x Homing Search Distance

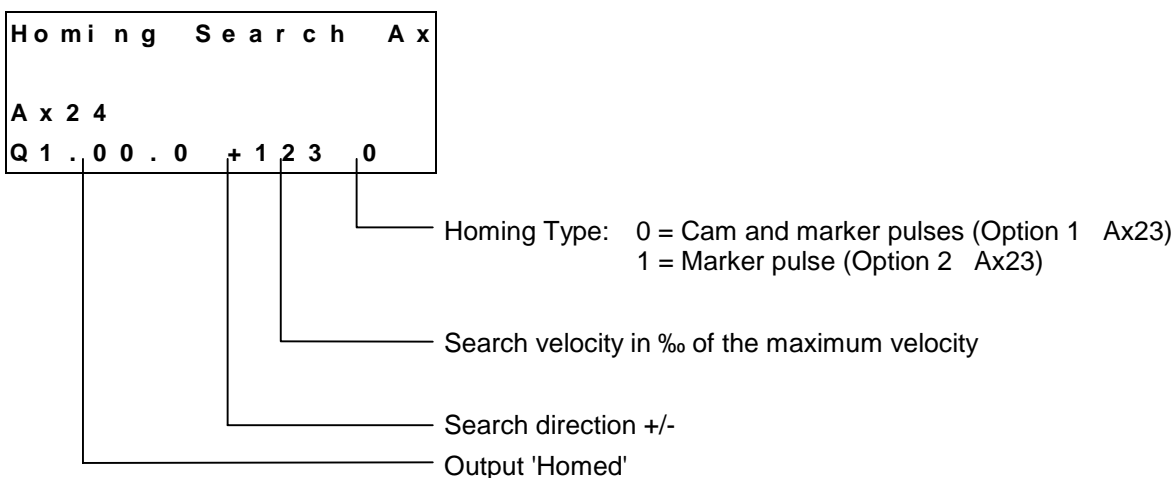

Ax28 Position Window

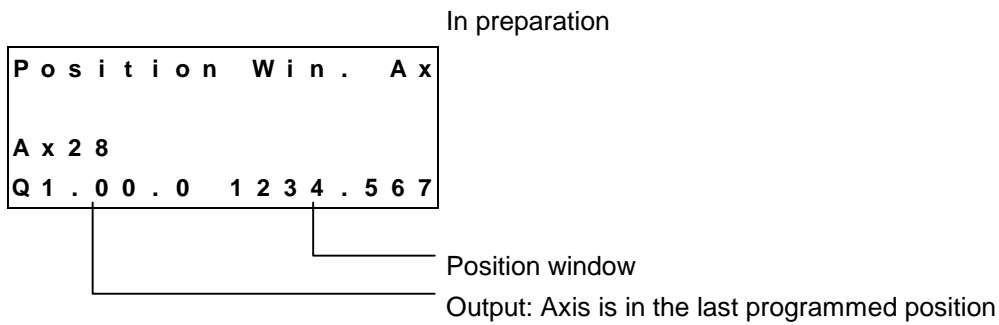

Ax29 Axis x Presignaling

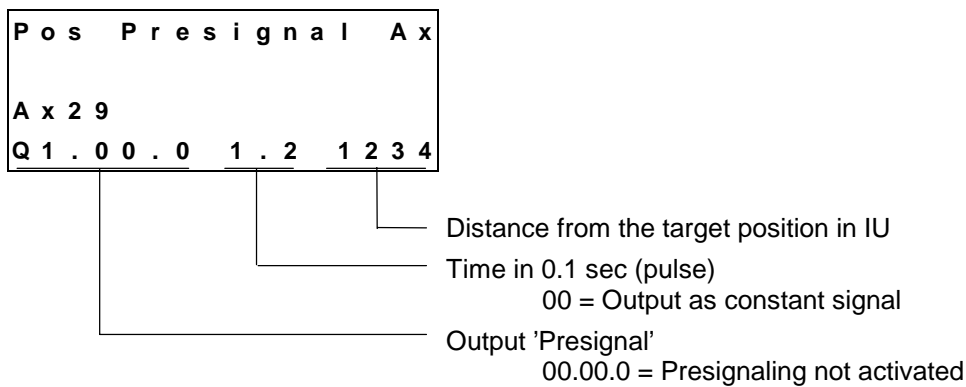

The presignaling function programmed in this parameter applies for every positioning command (POI, PSI, POA, PSA).

As soon as the distance still to be traversed becomes less than the programmed presignaling distance, the output is enabled.

The output remains enabled continuously, or for the programmed time period. The output is disabled each time a new feed instruction is received.

Ax30 Axis x Open Feed Roll

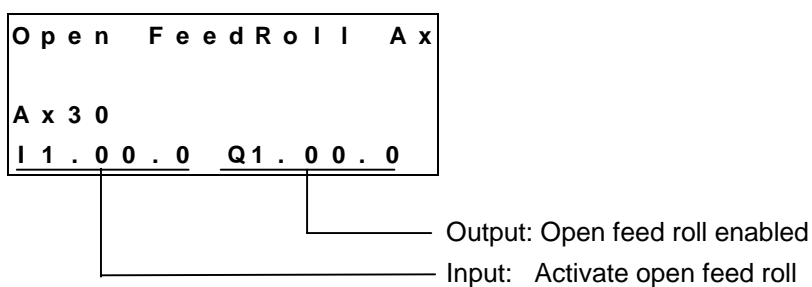

Ax31 Axis x Measuring Wheel Mode

M . Wheel Mode Ax
Ax 3 1
I 1 . 0 0 . 0

Input: Activate measuring wheel

This function is valid only when Measuring Wheel Mode is selected.

Ax32 Axis x Various Functions

Functions Ax
Ax 3 2
Q 1 . 0 0 . 0 Q 1 . 0 0 . 0

Output: Deceleration active

Output: Target velocity reached

Ax33 Axis x Cut Inhibit

Cut Inhibit Ax
Ax 3 3
I 1 . 0 0 . 0 Q 1 . 0 0 . 0

Output: Cut Inhibit

Input: Cut Inhibit

The function Cut Inhibit is valid only for Mode 5 'Flying Cutoff' and for Axis 1.

Ax34 Axis x Cut Vector

C	u	t		V	e	c	t		A	x
A	x	3	4							
I	1	.	0	0	.	0	0	1	2	3

Start Instruction: Manual cut vector program

Input: Immediate cut

The function 'Immediate Cut' is valid only for Mode 5 'Flying Cutoff' and for Axis 1.

8.3 General Parameters

B000 Enable Axis

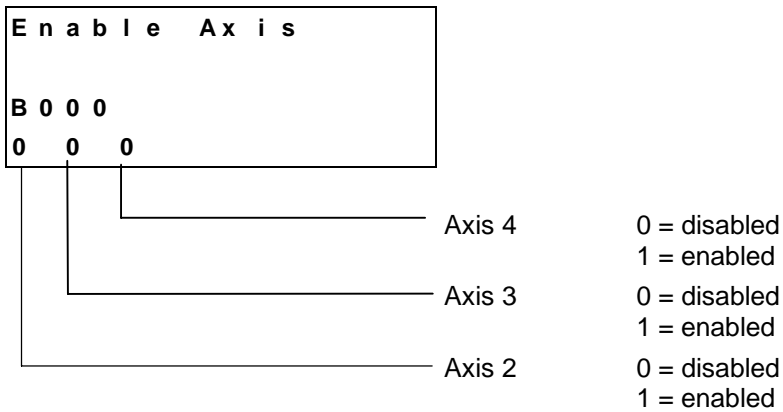

For an enabled axis, the corresponding parameter set Axxx must be programmed.

B001 Display

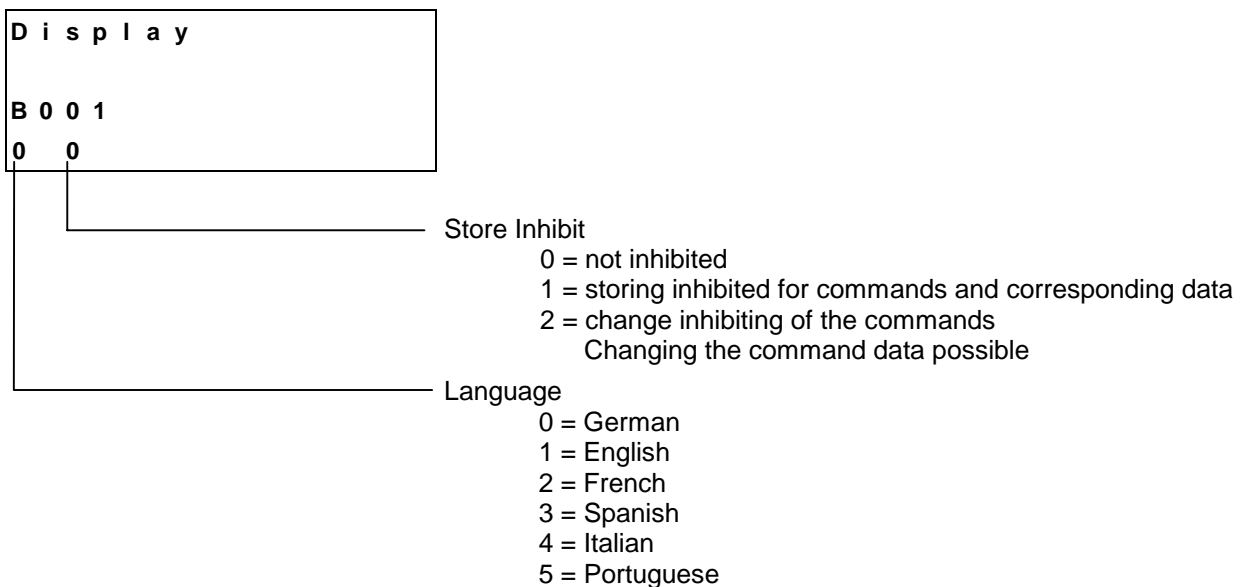

B002 RS Interface Format X6

R	S	F	o	r	m	a	t	X	6
B	0	0	2						
0	0	9	6	0	0	0	1	8	1

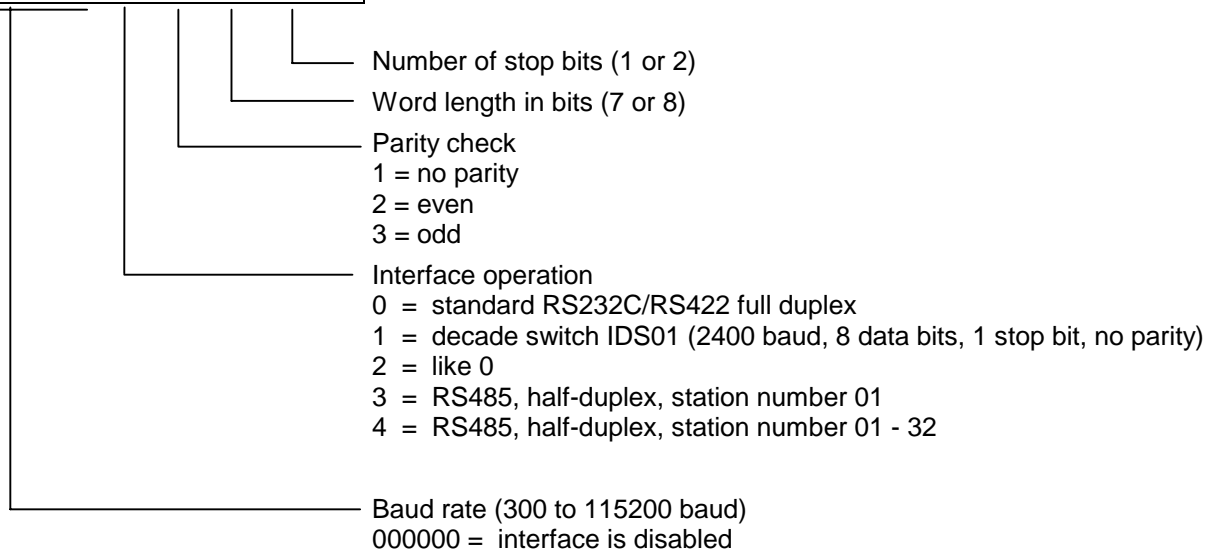

The CLM's serial interface can exchange data with the system in different ways. The selected transmission format is defined in Parameter B002. Details are described in section 'Serial Interfaces'.

If the decade switch input is preselected via an IDS01 unit, the other values need not be input.

Note: If Parameters B002 and B003 are correctly stored, the serial interface is immediately ready for operation. Erroneous inputs in the parameters disable the serial interface.

Example for decade switch querying:

For the decade switch, the transmission parameters for the interface are stipulated as follows:

2400 baud
 8 Data bits
 1 Start bit
 1 Stop bit
 no parity check

B003 RS Interface Functions X6

RS Functions X6					
B 0 0 3					
0	0	0 0	0	0 0 0	0 0 0

Reserved

Response delay in ms in RS485 Mode
000 = no delay

1 = in the event of a fault, an error message is sent automatically via the interface (RS 232 only).

0 = function disabled

Station number 01 - 32

Interface confirmation (Y CR LF)

0 = off

1 = on

Handshake / Checksum:

0 = checksum validation on

- hardware handshake RTS/CTS off

1 = checksum validation off

- hardware handshake RTS/CTS off

2 = checksum validation on

- hardware handshake RTS/CTS on

3 = checksum validation off

- hardware handshake RTS/CTS on

Explanation of the term 'Response Delay':

In RS485 Mode, once the CLM receives the last character of an 'LF' request (Linefeed: ASCII Code 10), it immediately switches over to Send Mode. With various RS-485 PC driver cards, this leads to problems if the cards are unable switch to Receive Mode quickly enough.

The interface can delay the switch from Receive to Send Mode by a defined amount of time (response delay).

The PC driver should be able to switch reliably from Send to Receive Mode within this time limit. The response delay is rounded up to whole number multiples of the controller cycle time (see Parameter B010).

B004 RS Interface Format X8

In preparation

as in Parameter B002

B005 RS Interface Functions X8

In preparation

as in Parameter B003

B006 Fieldbus Time Monitoring

F	i	e	l	d	b	u	s		T	i	m	e	M	o	n
B	0	0	6												
1	2	3	4	5											

Maximum cycle time in ms

Cyclic transmission of the process data via the fieldbus is monitored. If no new message is received within the maximum cycle time, the control unit generates the following error message:

37 Fieldbus Timeout

If the cycle time is preset by the fieldbus master, the actually used value is written to this parameter and can be read out for diagnostic purposes.

Note: A value of 0 means that monitoring is turned off!

For further information, see the Fieldbus chapter.

B007 Fieldbus Baudrate

F	i	e	l	d	b	u	s		B	a	u	d	r	a	t	e
B	0	0	7													
1	2	3	4	5	6	.	7									

Fieldbus Baudrate in kBaud

Here, the desired baud rate in increments of 1 kBaud can be set, if the fieldbus does not automatically detect the baud rate. If the set baud rate is not allowed, a default baud rate for the particular fieldbus is used. The actually used value is written to this parameter and can be read out for diagnostic purposes.

For further information, see the Fieldbus chapter.

B008 Fieldbus Formats

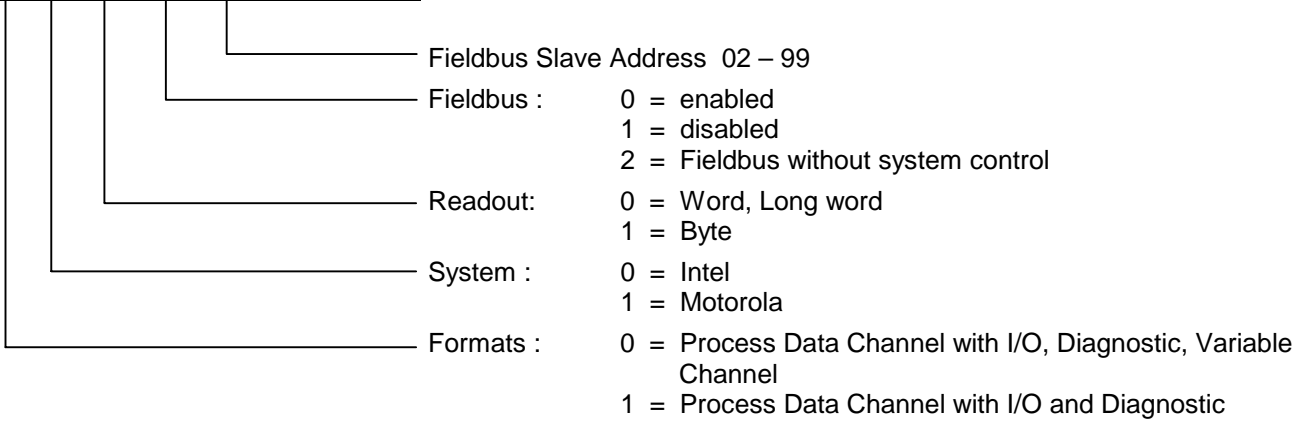
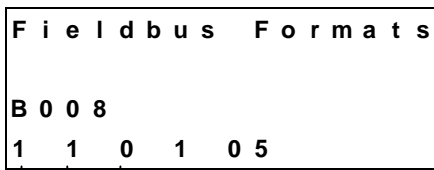

B009 Reserved (Free)



B010 Cycle Time

```
C y c l e   T i m e
B 0 1 0
2 . 0
```

└──────────────────────────┘ Cycle time in ms

- 2.0 = 2.0 ms
- 2.5 = 2.5 ms
- 3.0 = 3.0 ms
- 3.5 = 3.5 ms
- 4.0 = 4.0 ms

For all other values as listed above, the CLM sets the cycle time to the following values automatically.

- 1 or 2 axes programmed: 2 ms
- 3 axes programmed: 3 ms
- 4 axes programmed: 4 ms

The default setting for Parameter B010 is 0.0 for the automatic default setting.

While operating the CLM, if the message
 System Failure !
 Code #IRQOVL

appears, the cycle time is too short.

The value selected in Parameter B010 is too small. At a minimum, the default values should be programmed.

B011 Start Program Instruction - Task 2, Task 3

```
S t a r t   T a s k   2   &   3
B 0 1 1
0 2 2 2    0 3 3 3    1
```

└──────────────────────────┘ Task 3: Number of commands per cycle

└──────────────────────────┘ Task 3 start instruction
 If '0000' appears here, Task 3 is not enabled.

└──────────────────────────┘ Task 2 start instruction
 If '0000' appears here, Task 2 is not enabled.

For further details, see the chapter entitled 'Multitasking.'

B012 Start Program Instruction - Task 4, Task 5

S t a r t T a s k 4 & 5	
B 0 1 2	
0 0 0 0	0 0 0 0

Task 5 start instruction
If '0000' appears here, Task 5 is not enabled.

Task 4 start instruction
If '0000' appears here, Task 4 is not enabled.

Tasks 4 and 5 show the same behavior as Task 2.
For further details, see the chapter entitled 'Multitasking.'

B013 Logic Task

L o g i c T a s k
B 0 1 3

B014 Manual Vector

M a n u a l V e c t o r
B 0 1 4
I 1 . 0 0 . 0 1 0 1 0 0

Start instruction of the manual vector program

0 = Start only via input
1 = Jump into program
also for switch from Automatic to Manual

Input, program start with leading edge
00.00.0 = no input

For further information, see chapter entitled 'Vector Programming'.

B015 Interrupt Vector

Task 1 only

I n t e r r u p t V e c t o r
B 0 1 5
1 . 0 0 . 0 1 0 0 9 0 0

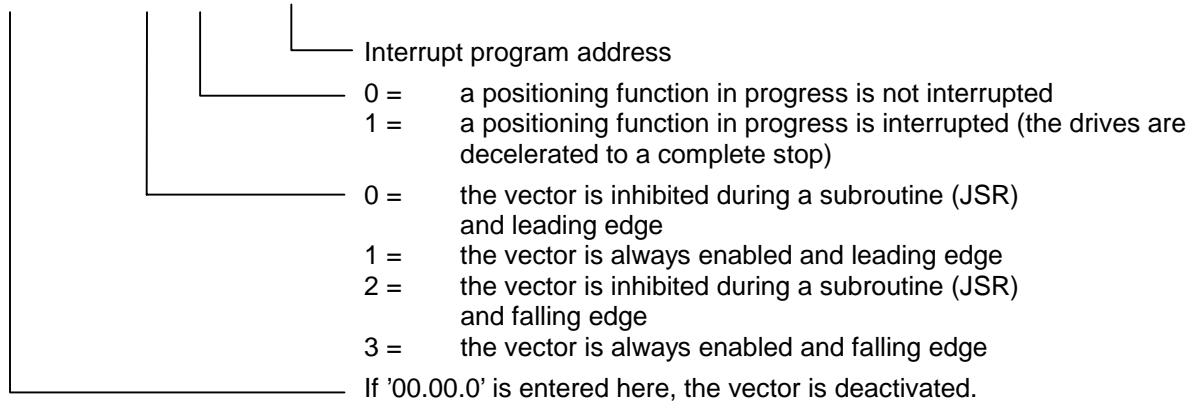

For further information, see chapter entitled 'Vector Programming.'

B016 Re-Start Vector

R e - S t a r t V e c t o r
B 0 1 6
0 0 0 0



When '0000' is input, no re-start program is present. The status is immediately restored.

B017 Analog Input / Override

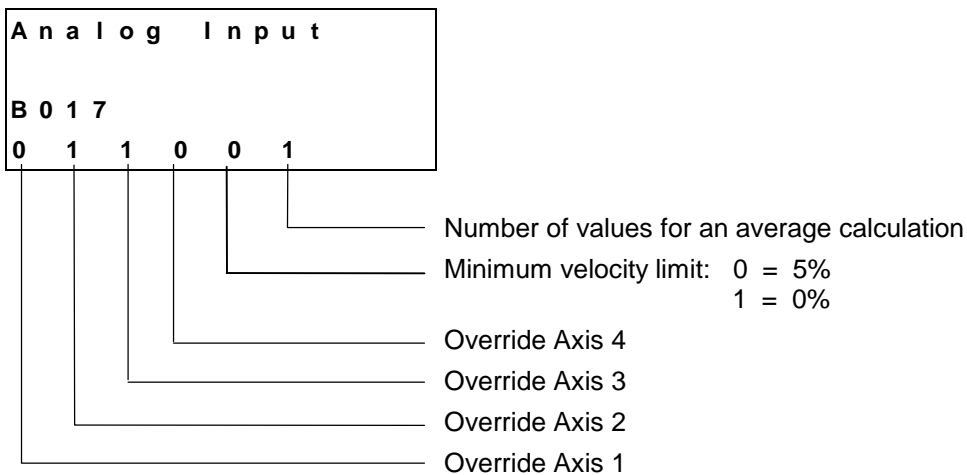

1) Average calculation of the analog input:

0 = No average	
1 = Average of	8 measurements per analog input
2 = Average of	16 measurements per analog input
3 = Average of	32 measurements per analog input
4 = Average of	64 measurements per analog input
5 = Average of	128 measurements per analog input
6 = Average of	256 measurements per analog input
7 = Average of	512 measurements per analog input
8 = Average of	1024 measurements per analog input
9 = Average of	2048 measurements per analog input

The values that have been read in can be queried via Status 45 or 49.

2) Override

The following inputs are possible for override:

- 0 = override is off
- 1 = Override via Analog Input 1
- 2 = Override via Analog Input 2
- 3 = Override via Analog Input 3
- 4 = Override via Analog Input 4
- 5 = Binary encoded override via Inputs I1.01.0 to I1.01.7
- 6 = Gray-coded override via Inputs I1.01.4 to I1.01.7

Any analog input can be assigned to an axis.

B018 Clear Outputs

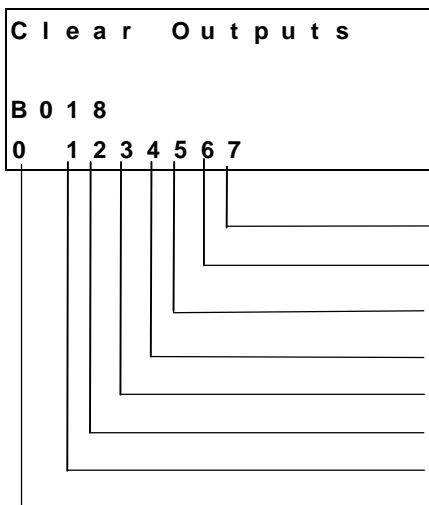

Outputs Q1.06

Outputs Q1.05

Outputs Q1.04

Outputs Q1.03

Outputs Q1.02

Outputs Q1.01

Outputs Q1.00

Fault code via outputs (Outputs Q1.00 – Q1.05)

0 = Function not enabled

1 = Fault code via outputs Q1.00

2 = Fault code via outputs Q1.01

3 = Fault code via outputs Q1.02

4 = Fault code via outputs Q1.03

5 = Fault code via outputs Q1.04

6 = Fault code via outputs Q1.05

Clear Outputs

This function allows the user to influence the clearing of outputs when faults occur.

For each group of 8 outputs, the following inputs are possible:

0 = Clear outputs when a fault or E-STOP occurs.

1 = Do not clear outputs when a fault or E-STOP occurs. The outputs are only cleared after the fault has been cleared.

2 = Do not clear outputs when error or E-STOP occurs or is cleared ('Clear' key, external 'Clear').

Note: If the BB relay drops out, all outputs present in the hardware are shut off internally.

Fault Code via Outputs

00 to 3F - General fault

40 to 6F - Fault, Axis 1

70 to 9F - Fault, Axis 2

A0 to CF - Fault, Axis 3

D0 to FF - Fault, Axis 4

Code Describing the Fault

00	No fault; Manual or Automatic Mode
01	No fault; Parameter Mode
02	Invalid input for Parameter XX
03	E-Stop
04	Battery is low
05	Parameter lost
06	Program lost
07	Division by zero
08	Wrong operating mode
0A	Invalid program command
0B	JSR - Nesting
0C	RTS - Nesting
0D	Input not in BCD Format
0E	Illegal instruction number
10	System error `Exception´
11	System error 'Stack overflow,' 'EPROM data lost', Position Loop - IRQ too long´
12	IDS - Interface interrupted
13	IDS – Checksum error
14	IDS – Format error
15	IDS – Data string too long
16	Wrong axis number
17	Hardware for Axis 3/4 missing
18	Wrong CLM hardware
19	Voltage monitoring $\pm 15V$
1A	REP - command not possible
1B	SAC - command not possible
1D	Input/Output No. wrong in command
2C	Track monitoring, Incremental Encoder 1
2D	Track monitoring, Incremental Encoder 2
2E	Track monitoring, Incremental Encoder 3
2F	Track monitoring, Incremental Encoder 4
30	Track monitoring, Measuring Wheel Incremental Encoder
31	Attempt to write to a system variable
32	Value of a variable during read access
33	Fieldbus card error
34	Fieldbus card initializing error
35	EOS command missing during 'Flying Cutoff Operation'
36	Axis 1 not in home position (Flying Cutoff)
37	Fieldbus Timeout
38	Logic Task Program Error
39	Logic Task Program Lost
40	Drive 1 not ready
41	Feed angle monitoring, Axis 1
42	Drive runaway, Axis 1
43	Position lag (following error), Axis 1, too large
44	Absolute encoder 1 not connected
45	Absolute encoder data error, Axis 1
46	Minimum travel limit, Axis 1
47	Maximum travel limit, Axis 1
48	Not homed, Axis 1
49	Homing: Cam too short, Axis 1
4A	Homing: No marker pulse, Axis 1
4B	Homing: Marker pulse position, Axis 1
4C	Encoder error, Measuring wheel
4D	Max. override, Axis 1
4E	Axis 1 is disabled
4F	Continuous marker pulse 1

Code Describing the Fault

50	Target position < Minimum travel limit, Axis 1
51	Target position > Maximum travel limit, Axis 1
52	HOM - Command not possible, Axis 1
70	Drive 2 not ready
71	Feed Angle Monitoring, Axis 2
72	Drive runaway, Axis 2
73	Position lag (following error), Axis 2, too large
74	Absolute encoder 2 not connected
75	Absolute encoder data error, Axis 2
76	Minimum travel limit, Axis 2
77	Maximum travel limit, Axis 2
78	Not homed, Axis 2
79	Homing: Cam too short, Axis 2
7A	Homing: No marker pulse, Axis 2
7B	Homing: Marker pulse position, Axis 2
7D	Max. override, Axis 2
7E	Axis 2 is disabled
7F	Continuous marker pulse 2
80	Target position < Minimum travel limit, Axis 2
81	Target position > Maximum travel limit, Axis 2
82	HOM - Command not possible, Axis 2
A0	Drive 3 not ready
A1	Feed angle monitoring, Axis 3
A2	Drive runaway, Axis 3
A3	Position lag (following error), Axis 3, too large
A4	Absolute encoder 3 not connected
A5	Absolute encoder data error, Axis 3
A6	Minimum travel limit, Axis 3
A7	Maximum travel limit, Axis 3
A8	Not homed, Axis 3
A9	Homing: Cam too short, Axis 3
AA	Homing: No marker pulse, Axis 3
AB	Homing: Marker pulse position, Axis 3
AD	Max. override, Axis 3
AE	Axis 3 is disabled
AF	Continuous marker pulse 3
B0	Target position < Minimum travel limit, Axis 3
B1	Target position > Maximum travel limit, Axis 3
B2	HOM - Command not possible, Axis 3

B019 Memory Display

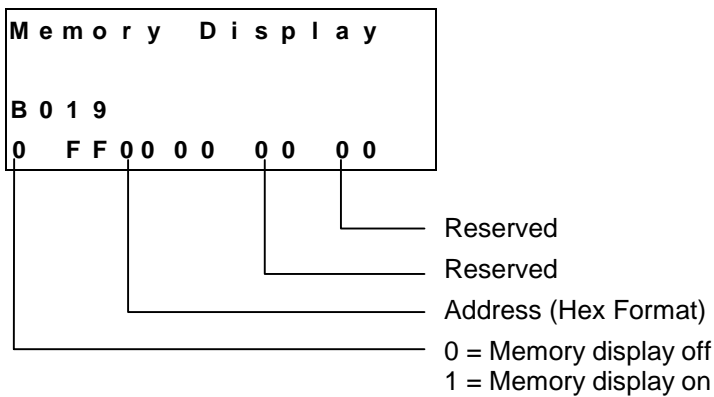

If the memory display is turned on, the contents of the entire RAM memory can be shown on the display. The memory address in Parameter B019 is a default address that is shown on the display after turning on the CLM or after a fault.

However, the address may be changed during operation by directly overwriting it.

With the 'plus' and 'minus' keys, the memory address can be changed byte-by-byte.

The letters 'A' to 'F' are composed by simultaneously pressing the key combination 'Save' and 'Number.' The following key combinations compose each letter:

Save  and 1 = A

Save  and 2 = B

Save  and 3 = C

Save  and 4 = D

Save  and 5 = E

Save  and 6 = F

8.4 Master Encoder Parameters

C000 Master Encoder 1, Measuring Wheel Encoder Data

```

M .   W h e e l 1   D a t a
C 0 0 0
0 0 0 0 0   1 5 0 0
  
```

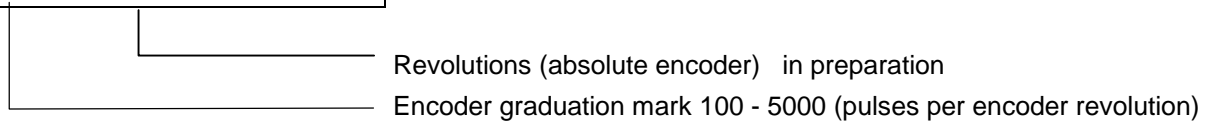

C001 Master Encoder 1, Measuring Wheel Encoder Type

```

M .   W h e e l 1   T y p e
C 0 0 1
5 0 0 0 0 0 0
  
```

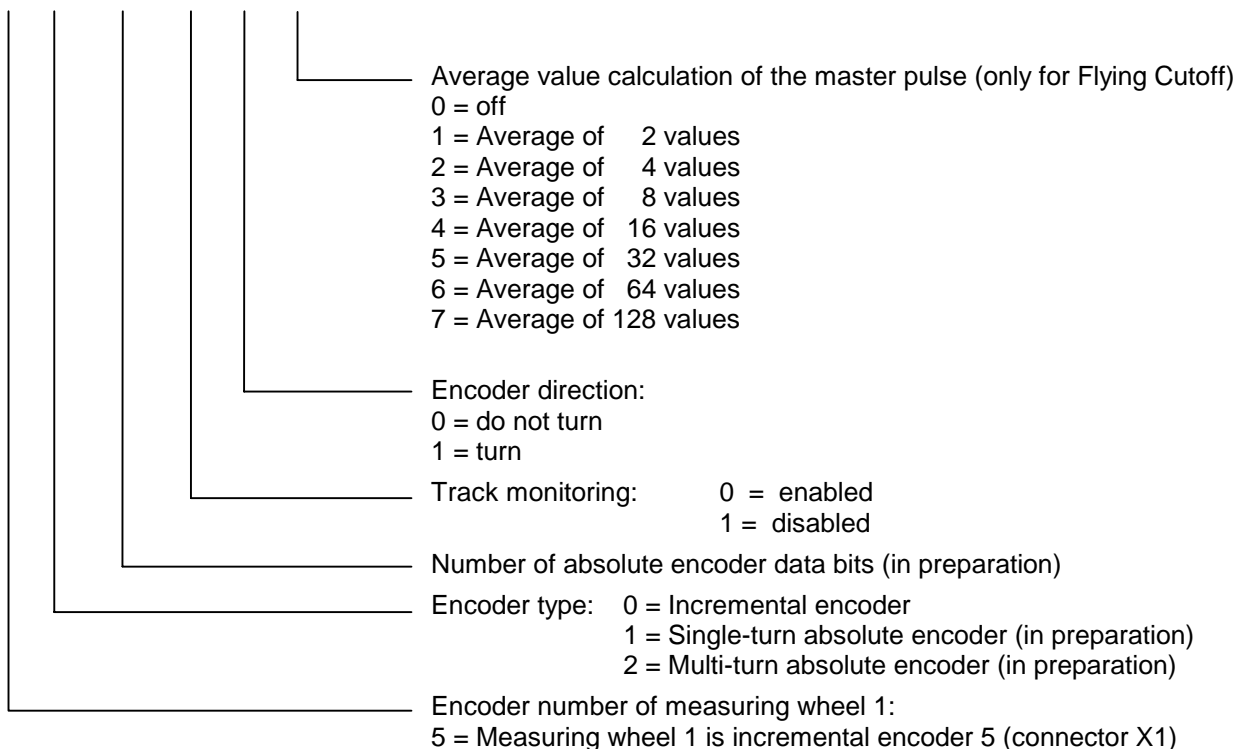

Measuring wheel 1 can be used for the functions 'Slave Axis,' 'Measuring Wheel Mode' or 'Flying Cutoff.' These functions are enabled in Parameter Ax00.

For further information, see the chapters entitled 'Measuring Wheel Mode' and 'Slave Axis / Synchronous Axis.'

C002 Master Encoder 1, Measuring Wheel Encoder Feed Constant (VK)

M - W h e e l 1 V K
C 0 0 2
0 5 0 0 . 0 0 0 0 0

Feed constant of measuring wheel 1 in IU

Input range: from 0.01000 to 5000.00000 in IU

C003 Master Encoder 1, Measuring Wheel Offset

M - W h e e l 1 O f f s e t
C 0 0 3
+ 1 2 3 4 5 . 6 7 8

This parameter currently has no function.

C004 Master Encoder 2, Measuring Wheel Encoder Data

In preparation
as in Parameter C000

C005 Master Encoder 2, Measuring Wheel Encoder Type

In preparation
as in Parameter C001

C006 Master Encoder 2, Measuring Wheel Encoder Feed Constant (VK)

In preparation
as in Parameter C002

C007 Master Encoder 2, Measuring Wheel Offset

In preparation
as in Parameter C003

8.5 List of CLM Parameters

Software : _____ Com. No. : _____
 Date : _____ Client/End user: _____
 Prep. by : _____ Serial No. : _____

Designation	Parameter	Data
Enable Axis	B0 00	
Display	B0 01	
RS Format X6	B0 02	
RS Functions X6	B0 03	
RS Format X8	B0 04	
RS Functions X8	B0 05	
Fieldbus Time Monitoring	B0 06	
Fieldbus Baudrate	B0 07	
Fieldbus Formats	B0 08	
Reserved (Free)	B0 09	
Cycle Time	B0 10	
Start Program Instr. Task 2 & 3	B0 11	
Start Program Instr. Task 4 & 5	B0 12	
Logic Task	B0 13	
Manual Vector	B0 14	
Interrupt Vector	B0 15	
Re-Start Vector	B0 16	
Analog Inputs/Override	B0 17	
Clear Outputs	B0 18	
Memory Display	B0 19	

Fig. 8-11: Parameter List B0.xx

Note: The parameters designated with '*' may only be altered with permission of the machine builder or drive manufacturer!

Designation	No.	Axis 1	Axis 2	Axis 3	Axis 4
Mode	Ax 00*				
Feed Constant	Ax 01*				
Gear	Ax 02*				
Min. Travel Limit	Ax 03				
Max. Travel Limit	Ax 04				
Modulo Value	Ax 05				
Maximum Velocity	Ax 06				
Jog Velocity	Ax 07				
Bipolar Acceleration Rate	Ax 08*				
Acceleration / Deceleration Rate	Ax 09*				
Jerk Constant	Ax 10				
Kv Factor	Ax 11*				
Drive Sensitivity	Ax 12*				
Reserved (Free)	Ax 13				
Monitoring Window	Ax 14				
Feed Angle Monitoring/Interrupt	Ax 15				
Encoder Difference	Ax 16				
Absolute Encoder Monitoring Window	Ax 17				
Reserved (Free)	Ax 18				
Encoder Data	Ax 19				
Encoder Type	Ax 20				
Drive Direction	Ax 21				
Absolute Encoder Home Position	Ax 22				
Homing I/O	Ax 23				
Homing Search Distance	Ax 24				
Homing Offset	Ax 25				
Reserved (Free)	Ax 26				
Switching Threshold	Ax 27				
Position Window	Ax 28				
Presignaling	Ax 29				
Open Feed Roll	Ax 30				
Measuring Wheel Mode	Ax 31				
Various Functions	Ax 32				
Cut Inhibit	Ax 33		---	---	---
Cut Vector	Ax 34		---	---	---

Fig. 8-12: Parameter List Ax.xx

Note: The parameters designated with '*' may only be altered with permission of the machine builder or drive manufacturer!

Designation	Parameter	Data
Master Encoder 1, Meas. Wh. Data	C0 00	
Master Encoder 1, Meas. Wh. Type	C0 01	
Master Encoder 1, Meas. Wh. Feed Constant	C0 02	
Master Encoder 1, Meas. Wh. Offset	C0 03	
Master Encoder 2, Meas. Wh. Data	C0 04	
Master Encoder 2, Meas. Wh. Type	C0 05	
Master Encoder 2, Meas. Wh. Feed Constant	C0 06	
Master Encoder 2, Meas. Wh. Offset	C0 07	

Note: The parameters designated with '**' may only be altered with permission of the machine builder or drive manufacturer!

8.6 Minimum and Maximum Values for Parameter Input

Parameter	Designation		Min. Data	Max. Data
Ax 01	Feed Constant	IU	0.0100	5000.00000
Ax 05	Modulo Value	IU		
Ax 06	Maximum Velocity	IU/sec	0.100	50000.000
Ax 07	Jog Velocity	IU/sec	0.100	50000.000
Ax 08	Acceleration Rate	IU/sec ²	1	999999
Ax 10	Jerk Constant	sec	0.000	1.024
Ax 11	Kv Factor		0.01	20.00
Ax 12	Drive Sensitivity	Volts	0.5	10.0
Ax 19	Encoder Data		100	5000
C000	Master Encoder 1 Data		100	5000
C002	Master Encoder 1 Feed Constant	IU	0.0100	5000.00000
C004	Master Encoder 2 Data		100	5000
C006	Master Encoder 2 Feed Constant	IU	0.0100	5000.00000

Fig. 8-13: Parameter Input Range

9 Interfaces

9.1 Inputs, Outputs and Marker Flags

Designation

The designation of the inputs, outputs and marker flags.

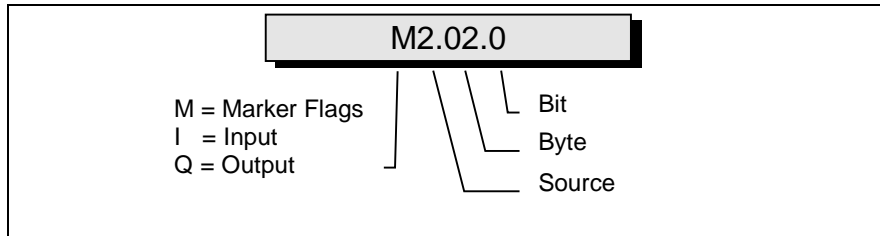

Fig. 9-1: Structure of the Inputs / Outputs / Marker Flags

e.g. I1.00.6

I Input

I1 Input, Connector X3

I1.00 Input, Connector X3, Group 0 (Byte)

I1.00.6 Input, Connector X3, Group 0, Bit 6

Inputs

The inputs are designated with 'I.' They can be programmed and processed in the parameters, commands, and in the Logic Task. They are read at the beginning of each cycle or at the start of the Logic Task.

Outputs

The outputs are designated with 'Q.' They can be programmed and processed in the parameters, commands, and in the Logic Task. They are processed at the beginning of each cycle or at the start of the Logic Task. If an output is designated in the Logic Task, this output can no longer be processed in one of the NC Tasks or via the functions activated in the parameters.

Flags

The marker flags are designated with 'M.' They can be programmed and processed in the parameters, commands, and in the Logic Task. They are processed at the beginning of each cycle or at the start of the Logic Task. To avoid confusion, the NC Task and the Logic Task have different marker flags. Transfer flags handle the exchange of information between the NC Task and the Logic Task.

Source

Origin or category

Byte

8 inputs, outputs or marker flags are grouped together (to form bytes).

BIT

The bit designates an input, output or marker flag. Numbering is from 0 to 7.

Inputs

The CLM has 112 inputs.

All CLM input signals are galvanically isolated from the control using an opto-electronic coupler.

The signal voltage of the inputs is +24 V external voltage. Under no circumstances may the CLM's 24 V supply voltage be used to supply power to the inputs.

The current consumption of each input is approximately 8 mA at +24 V external voltage.

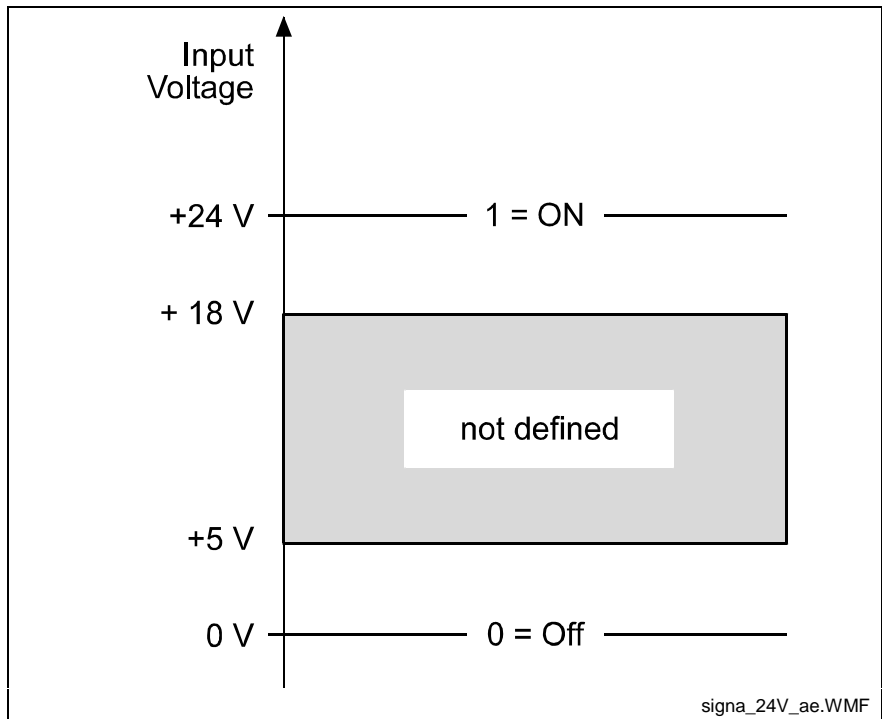

Fig. 9-2: Signal Level of the Inputs

The terms '1,' 'On' or 'Activated' can all be defined by 24 V signal level.

The terms '0,' 'Off' or 'Deactivated' can all be defined by 0V signal level.

Depending upon the function to be initiated, the CLM differentiates between two signal types:

Static Signal Type

This function is shown as long as the corresponding signal level is constantly (statically) present. Most functions are 'active high,' which means they are active at signal level '1.' A few functions are 'active low,' which means they are active at signal level '0.' To differentiate, the 'active low' functions have a "NOT" line over their descriptions.

Dynamic Signal Type

This function is not dependent on a constantly present signal level. This function is activated by a rising signal edge (signal level increases from '0' to '1') or a falling signal edge (signal level decreases from '1' to '0').

The input signals can be categorized into five groups, depending upon their definitions:

	Input Signal	Pre-programmed	User-programmable
1.	Safety Inputs	E-Stop	Interrupt Feed angle monitoring
2.	Start-up Information	Enable Axis x	
3.	Operating Modes	Parameter _____ Automatic / Manual	
4.	Commands	Start _____ Immediate Stop External Clear Jog Forward Axis x Jog Reverse Axis x Restart Raster	Measuring Wheel Mode Homing Manual Vector Interrupt Vector Belt Load Relief
5.	Auxiliary Inputs		I1.xx.x

Fig. 9-3: Input Signals

All pre-programmed inputs are designated as 'system inputs' in the rest of the manual.

All user-programmable inputs are designated as 'auxiliary inputs.'

Type	CLM
System Inputs	24
Auxiliary Inputs	88

Fig. 9-4: Inputs

Safety Inputs

E-Stop

Connector No. 3 / Pin No. 3: 10.00.2

This input must be wired, including for fieldbus operation.

In the operating state, +24V external must be present at this signal. If this signal is missing, the refresh contact 'Bb' (connector 5, pins 3 & 4) in the CLM opens and the command values are set without a transition to 0V.

All outputs, including the output 'Error Message,' are turned off. The drive is stopped by cutting the motor supply power (Refresh Bb Contact), using Command Value = 0V, by clearing drive enable and using the activated mechanical brake.

For accident prevention, however, one cannot depend solely on this functionality of the CLM.



CAUTION

Error During Handling and Installation

Equipment damage can occur.

⇒ Danger of injury to personnel because of erroneous drive movements must be eliminated at the facility in which the drives are used! A 100% effective measure for stopping the drive is only possible by disconnecting the motor power supply (E-Stop Sequence).

See also Parameter Ax15, Inputs 'Interrupt' and 'Feed Angle Monitoring.'

Start-up Information

Enable Axis 1
Connector No. 3 / Pin No. 6: I0.00.5

Enable Axis 2
Connector No. 3 / Pin No. 7: I0.00.6

Enable Axis 3
Connector No. 22 / Pin No. 1: I0.02.0

Enable Axis 4
Connector No. 22 / Pin No. 4: I0.02.3

These inputs must be wired, including for fieldbus operation.

The axis enable inputs are used to enable each axis individually. If an enable signal is not present, the control enable output and the brake output of the axis in question are off.

When switching to Automatic Mode, the axis enable signals must be present; otherwise the error message 'Enable' follows.

When the signal 'Enable Axis X' is cleared, an axis that has been homed using an incremental encoder remains homed in Manual Mode. The absolute reference point is not lost.

Note: Within the 'Enable' message, the message 'Motor ready for operation,' which means that power is on, must be maintained.

Note: For an absent enable signal, parameter input is possible in Parameter Mode, and program input is possible in Manual Mode!

Operating Modes

Parameter Mode

Connector No. 3 / Pin No. 1: I0.00.0
Fieldbus : I2.00.0

In this mode, users can program the parameters .

The input Parameter Mode is also dominant for system inputs via the fieldbus. Therefore, Parameter Mode can be forced independently from the fieldbus.

Automatic / Manual

Connector No. 3 / Pin No. 2: I0.00.1
Fieldbus : I2.00.1

The CLM has 3 possible operating modes:

- Parameter
- Automatic
- Manual

Each particular operating mode is invoked via two hardware inputs. If neither 'Parameter Input' nor 'Automatic' is present as the operating mode, the CLM is in the 'Manual' operating mode.

If both 'Parameter Input' and 'Automatic' inputs are on, the error message 'Operating Mode' is issued.

Switching Example:

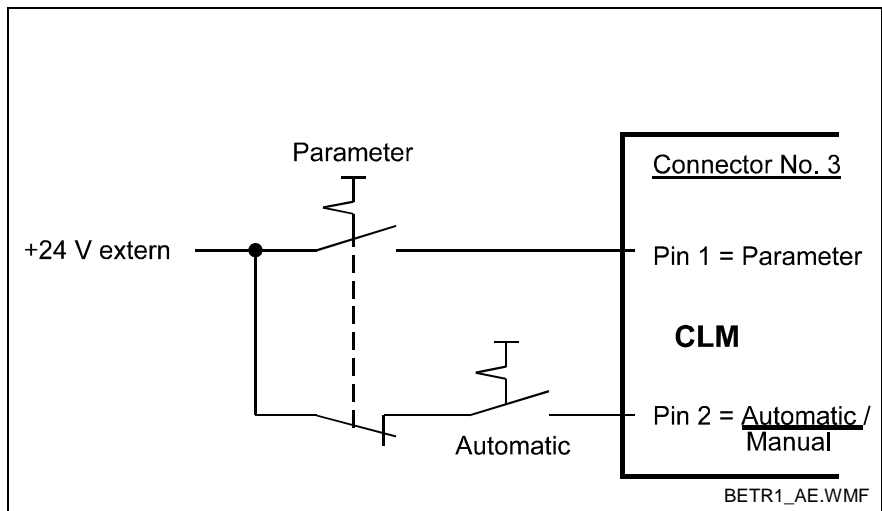

Fig. 9-5: Example of Operating Mode Switch

Command Inputs

Start

Connector No.3 / Pin No. 4: 10.00.3

Fieldbus : 12.00.3

If a rising edge is present at the 'Start' input, the program is started when Automatic is preselected.

Immediate Stop

Connector No.3 / Pin No. 5: 10.00.4

Fieldbus : 12.00.4

If the signal at the 'Immediate Stop' input is lost, the program flow is stopped immediately. If the feed drive is in motion, it immediately decelerates to a standstill via the programmed deceleration. The remaining travel distance is stored and is the first to be executed after the next start. There is no loss of dimensions.

External Clear

Connector No.3 / Pin No. 8: 10.00.7

Fieldbus : 12.00.7

When a positive edge is present at the input 'External Clear', any displayed fault is cleared. This input is only queried from the software for 'E-Stop' and 'Fault.' When the program or parameters are lost, the clear function is only available using the 'CL' key.

Jogging

Jog Forward Axis 1		
Connector No.3 / Pin No. 9:		I0.01.0
Fieldbus	:	I2.01.0
Jog Forward Axis 2		
Connector No.3 / Pin No. 11:		I0.01.2
Fieldbus	:	I2.01.2
Jog Forward Axis 3		
Connector No.22 / Pin No. 2:		I0.02.1
Fieldbus	:	-----
Jog Forward Axis 4		
Connector No.22 / Pin No. 5:		I0.02.4
Fieldbus	:	-----

If a signal is present at the 'Jog Forward Axis x' input, the drive moves forward (positive direction) at the velocity entered in Parameter 'Ax07' when in Manual Mode.

Jog Reverse Axis 1		
Connector No.3 / Pin No. 10:		I0.01.1
Fieldbus	:	I2.01.1
Jog Reverse Axis 2		
Connector No.3 / Pin No. 12:		I0.01.3
Fieldbus	:	I2.01.3
Jog Reverse Axis 3		
Connector No.22 / Pin No. 3:		I0.02.2
Fieldbus	:	-----
Jog Reverse Axis 4		
Connector No.22 / Pin No. 6:		I0.02.5
Fieldbus	:	-----

If a signal is present at the 'Jog Reverse Axis x' input, the drive moves in reverse (negative direction) at the velocity entered in Parameter 'Ax07' when in Manual Mode.

There is no movement if no signal, or an 'Immediate Stop,' 'Interrupt' or 'Feed Monitoring' signal is present!

Restart

Connector No. 3 / Pin No. 15:		I0.01.6
Fieldbus	:	-----

If the output 'Restart Possible' is active, the program can be continued from the place where it was stopped with a low-to-high input signal at this input.

This input is available only in Automatic Mode.

For further information, see the chapter entitled 'Functions.'

Raster

Connector No.3 / Pin No. 16:		I0.01.7
Fieldbus	:	-----

This is a fast signal input (detection in max. of 100 μ s). The input can only be used for program commands SRM (REF) and RMI.

Available Inputs

Inputs 11.00.0-11.01.7 Connector No. 3 / Pin No. 17 to 32

Inputs 11.02.0-11.05.7 Connector No. 11 / Pin No. 1 to 32

Inputs 11.06.0-11.09.7 Connector No. 12 / Pin No. 1 to 32

Inputs 11.10.0-11.10.7 Connector No. 22 / Pin No. 9 to 16

All user-programmable outputs can be cleared via the user-programmable inputs.

The inputs, if programmed accordingly, can also be used for the following functions:

Interrupt	- Parameter Ax15
Feed Angle Monitoring	- Parameter Ax15
Measuring Wheel Mode	- Parameter Ax31
Homing	- Parameter Ax23
Manual Vector	- Parameter B014
Interrupt Vector	- Parameter B015
Belt Load Relief	- Parameter Ax30

There are a total of 88 available inputs.

Outputs

The CLM has 69 outputs .

To attain a high resistance to faults, the output signals from the internal bus system are galvanically isolated and operated by external voltage.

The maximum selectable current is 80 mA at a maximum of 30V.

The output signals can be categorized into four groups, depending upon their definitions:

	Output Signal	Pre-programmed	User-programmable
1.	Security Outputs	Fault Indication	
2.	Start-up Information	Drive Enable Axis x Brake Axis x Restart Possible Run Task Inhibit Operation	
3.	Operating Modes	Parameter Automatic Manual	
4.	Auxiliary Outputs		Q1.xx.x

Fig. 9-6: Output Signals

All pre-programmed outputs are designated as 'system outputs' in the rest of the manual.

All user-programmable outputs are designated as 'auxiliary outputs.'

Type	CLM
System Outputs	18
Auxiliary Outputs	51

Fig. 9-7: Outputs

Security Outputs

Fault

Connector No.4 / Pin No. 6: Q0.00.5

In the event of a fault, the output is immediately deactivated.

A fault can only be cleared via the input 'External Clear,' the  key, or via the serial interface.

Start-up Information

Drive Enable

Drive Enable Axis 1
 Connector No.4 / Pin No. 4: Q0.00.3 or
 Connector No. 7 / Pin No. 1 (max. 10 mA)

Drive Enable Axis 2
 Connector No. 4 / Pin No. 7: Q0.00.6 or
 Connector No. 7 / Pin No. 2 (max. 10 mA)

Drive Enable Axis 3
 Connector No. 4 / Pin No. 15: Q0.01.6 or
 Connector No. 19 / Pin No. 6 (max. 10 mA)

Drive Enable Axis 4
 Connector No. 4 / Pin No. 16: Q0.01.7 or
 Connector No. 19 / Pin No. 7 (max. 10 mA)

Drive Enable occurs in Automatic or Manual Mode, when +24 V is present at the following inputs:

- $\overline{\text{E-Stop}}$
- Enable Axis 1
- Enable Axis 2
- Enable Axis 3
- Enable Axis 4

In case of a fault or after clearing the Enable signal for the axes, Drive Enable is immediately disabled. For a direct connection to the TDM or KDS, Drive Enable is also available on the terminal strips X7 and X19. (load capacity, approx. 10 mA)

The Drive Enable function is to be connected directly with the drive amplifier via a relay (not via a PLC!).

Note: In Automatic Mode, Drive Enable must be present for activated axes (at all times for Axis 1). Axis activation is set in Parameter B000. Otherwise, the error message 'Not Ready' is generated.

Brake Output

Brake Axis 1
 Connector No. 4 / Pin No. 5: Q0.00.4
 Brake Axis 2
 Connector No. 4 / Pin No. 8: Q0.00.7
 Brake Axis 3
 Connector No. 22 / Pin No. 17: Q0.02.0
 Brake Axis 4
 Connector No. 22 / Pin No. 18: Q0.02.1

When switching the power supply to the CLM on, a check of the set parameters is completed, as well as a calculation of the resulting values.

During this time, the drives must be disabled. Therefore, the brakes are only enabled when 'Manual' or 'Automatic' Modes are allowed, and Drive Enable is on.

After Drive Enable is switched on, the brake is enabled with a 200 ms delay.

In case of a fault or after clearing the Enable signal for the axes, the brake is immediately disabled.

If the output signal is switched again via external logic, the CLM receives this information when the axis enable signal is cleared.

In addition, the user-definable outputs can be used for the following start-up information:

Position reached	- Parameter Ax27
Presignalling	- Parameter Ax29
Axis homed	- Parameter Ax24
Belt load relief active	- Parameter Ax30
Velocity reached	- Parameter Ax32
Deceleration active	- Parameter Ax32
Position lag greater than limit	- Parameter Ax14

Restart

Restart possible
 Connector No. 4 / Pin No. 9: Q0.01.0

This output is set after a shutdown situation. A shutdown situation is present if a power loss or power surge occurs to the 24 V power supply. In the event of a shutdown situation, an error message is issued by the CLM or the control goes into E-Stop.

A set output shows that the continuation of the last active program is possible at the point of interruption.

The output can also be set in Manual Mode. However, a restart is possible only in Automatic Mode.

Run Task

Run Task
Connector No. 4 / Pin No. 10: Q0.01.1

This output shows that a program in Task 1, 2, 4 and 5 (when enabled) is being processed. It is set when the CLM is in Automatic Mode, a start signal was issued, and no Immediate Stop is present.

If the program was stopped (e.g. via the signal 'Immediate Stop,' the 'JST' command or switching to 'Manual' Mode), the output is cleared.

A manual vector program does not cause the output to be set!

Inhibit Operation

Connector No. 4 / Pin No. 14: Q0.01.5

This output is set if a move command cannot be executed because, for example, an interrupt or feed angle monitoring is present or an axis enable signal is not present in Jog Mode.

Operating Modes**Parameter Mode**

Connector No. 4 / Pin No. 3: Q0.00.2

If the operating mode 'Parameter Input' is accepted by the CLM, this output is powered.

Automatic Mode

Connector No. 4 / Pin No. 2: Q0.00.1

If the operating mode 'Automatic' is accepted by the CLM, this output is powered.

Manual Mode/Automatic Mode

Connector No. 4 / Pin No. 1: Q0.00.0

If the operating mode 'Homing' is accepted by the CLM, this output is powered.

User-Programmable Outputs

Outputs	Q1.00.0-Q1.01.7	Connector No. 4 / Pin No. 17 to 32
Outputs	Q1.02.0-Q1.05.7	Connector No. 13 / Pin No. 1 to 32
Outputs	Q1.06.0-Q1.06.2	Connector No.22 / Pin No. 19 to 21

All outputs are user-definable in the user program.

Moreover, these user-definable outputs can be used for different functions.

Monitoring Inputs and Outputs

Ready for Operation (Bb) Connector No.5 / Pin No. 3 and 4

This output is a potential-free relay contact. The allowable contact load is 250 mA / 24 V.

The internal hardware and software conditions are monitored. The contact does not close until the internal conditions have been checked and the security inputs are present.

This contact is opened when an E-Stop occurs. The status of this relay is shown using the LED 'H1' above connector X7 on the front of the CLM. If the LED is off, the relay contact is opened.

Note: The contact Ready for Operation ('Bb') must be included in the E-Stop chain!

Flags

The marker flags can be distinguished as follows:

Source	Byte	Function
0	00...49	System Flags (Inputs)
1	00...49	System Flags (Outputs)
2	00...19	NC Marker Flags
3	00...07	Saved NC Marker Flags
4	00. .09	Transfer Flags NC →Logic Task
5	00...09	Transfer Flags Logic Task → NC
6	00...19	Saved Logic Task Marker Flags
6	20...39	Logic Task Marker Flags

Fig. 9-8: Marker Flag Categories

System Flags (Inputs)

In preparation
Here, the requirements are mirrored.
These marker flags can only be read by the programs.

System Flags (Outputs)

In preparation
Here, the CLM conditions are mirrored.
These marker flags can only be read by the programs.

NC Marker Flags

M2.00 - M2.19

These marker flags can be read and written via NC commands. These marker flags are cleared when exiting Automatic Mode, losing power or when a fault occurs.

Saved NC Marker Flags

M3.00 - M3.07

These marker flags can be read and written via NC commands. They are not cleared, even when power is lost.

**Transfer Flags NC
→ Logic Task**

M4.00 - M4.09

These marker flags are only for signal transfers between the NC Tasks and the Logic Task. They can be read and written by the NC Tasks. The Logic Task can only read these marker flags.
These marker flags are cleared when power is lost.

**Transfer Flags Logic
Task → NC**

M5.00 - M5.09

These marker flags are only for signal transfers between the Logic Task and the NC Tasks. They can be read and written by the Logic Task. The NC Tasks can only read these marker flags.
These marker flags are cleared when exiting Parameter Mode, when a fault occurs in the Logic Task, or when power is lost.

Saved Logic Task Marker Flags

M6.00 - M6.19

These marker flags can be read and written by the Logic Task. They are not cleared, even when power is lost.

Logic Task Marker Flags

M6.20 - M6.39

These marker flags can be read and written by the Logic Task. These marker flags are cleared when exiting Parameter Mode, when a fault occurs in the Logic Task, or when power is lost.

9.2 Serial Interfaces

General Information

The CLM's integrated serial RS232C or RS485 interface supports programming of the control via personal computer (PC) in any operating mode.

In addition, status signals, the currently executing program and the parameters can be requested.

Parameters can only be transferred to the control in 'Parameter' Mode.

The interface is standardized according to DIN 66020 (CCITT V.24) or EIA-RS232C and equipped for full duplex operation.

The data flow between the CLM and the PC is controllable via the 'X-ON / X-OFF'-Protocol (software handshake) or the RTS-CTS Handshake.

Data transfer is executed in 'ASCII' format.

Connecting the Interface

RS232C - V.24 Interface:

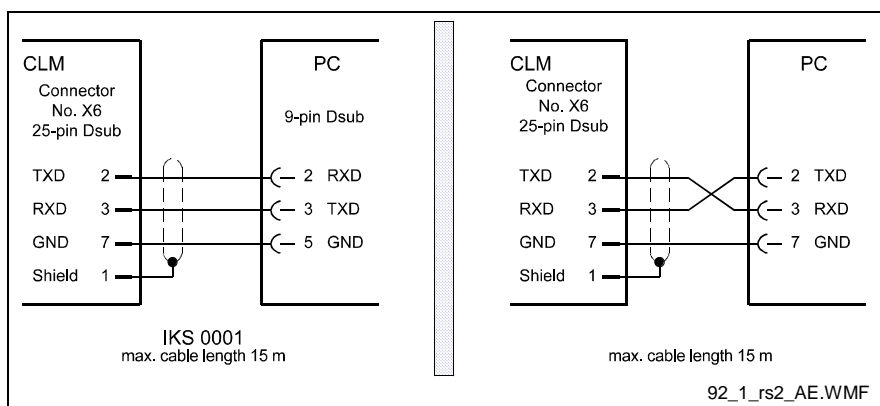

Fig. 9-9: Connection of the Serial Interface

Definition of the signal lead, according to DIN 66020:

Connection 2 = RxD (Received Data) Data Lead

Data is received via this channel.

The 'Off' condition has the logical value 'One.'

Connection 3 = TxD (Transmitted Data) Data Lead

Data are sent via this channel.

The 'Off' condition has the logical value 'One.'

Connection 5 = GND (Signal Ground) Ground Lead

This line is the common return for all signal leads.

Signal Level: To operate the interface, the following signal levels are required:

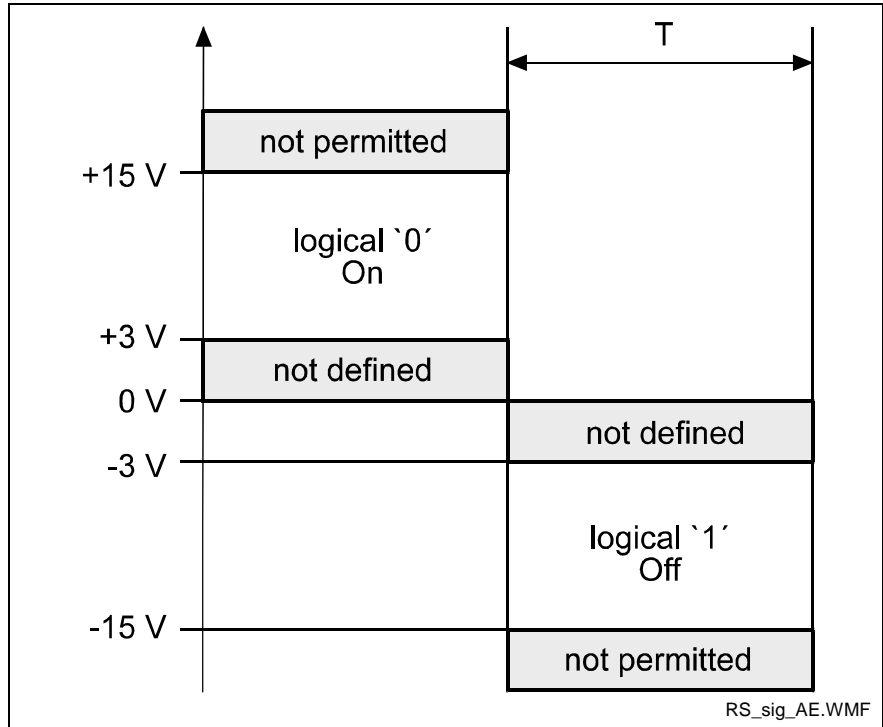

Fig. 9-10: Signal Levels for Interface

Data Format: A character is comprised of the following:

- 1) 1 start bit
- 2) 7 or 8 data bits (word length)
- 3) 1 parity bit (not present when no parity check is programmed)
- 4) 1 or 2 stop bits, depending on word length

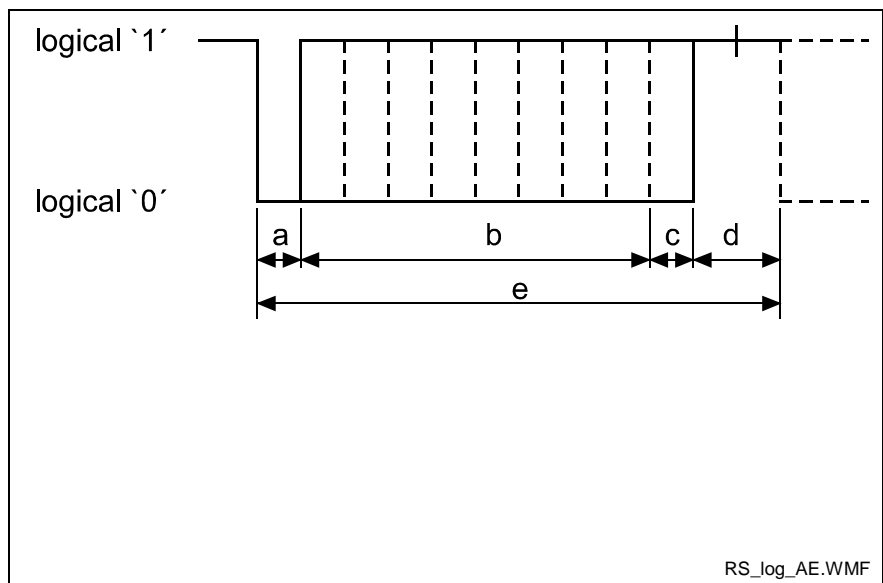

Fig. 9-11: Data Format

RS 485 Serial Data Interface: With help from the RS485 bus system, up to 32 CLM controls can be connected to a PC with the appropriate interface.

In this case, the PC is defined as the master device and the connected CLM controls as slave devices.

The station number of each CLM is input into the CLM via parameters.

For all data transmissions, the station number is also transmitted.

Data Transmission: For the transmission of or request for information, the station number is input after the first control character instead of the space character. For the station number, values between 1 and 32 are allowed.

For station numbers 10 to 32, a letter is input, according to the following list:

Station No.	Transmit Value
1	1
2..9	2..9
10	A
11	B
12	C
13	D
14	E
15	F
etc., through	
32	W

Example for Station No. 10 (Hex = A):

Request to the CLM:

```
?AN0000CR LF
```

Response from the CLM:

```
#AN0000_Instruction Contents CR LF
```

For further information, see description for Parameters B002 and B003.

The data transmission format for the serial interface is set in Parameters B002 and B003. Here, it is also determined whether the interface operates as a data interface or as an interface to the decade switch unit 'IDS01.'

Interface Parameters

B002 Interface Format X6

RS - Format										X 6
B 0 0 2										
0	0	9	6	0	0	0	1	8	1	

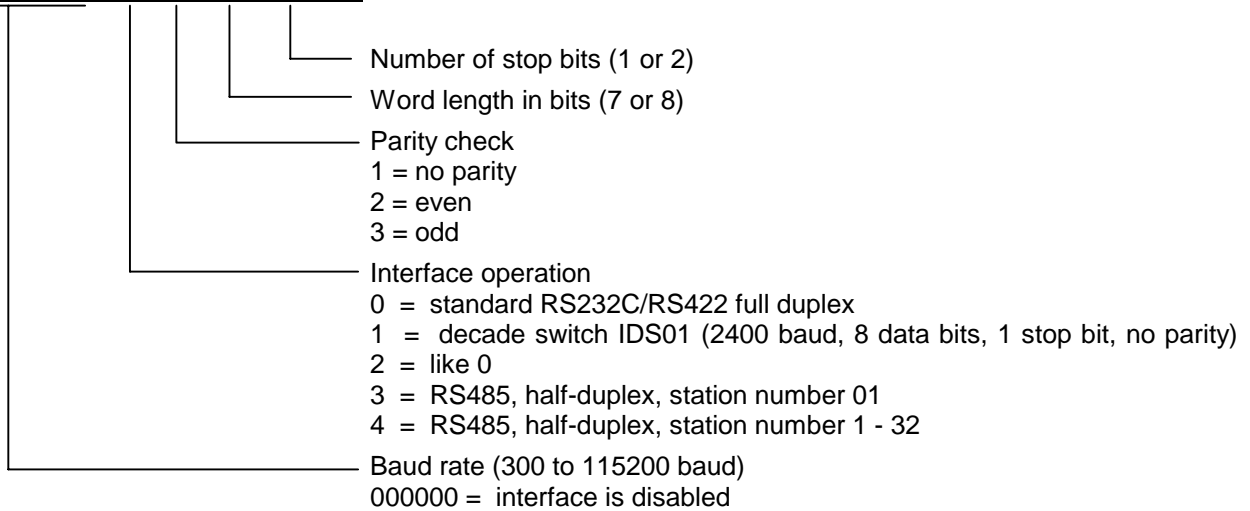

The CLM's serial interface can exchange data with the system in different ways. The selected transmission format is defined in Parameter B002: If the decade switch input is preselected via an IDS01 unit, the other values need not be input.

Baud Rate: The desired baud rate can be selected from the following list of values:

Baud Rate
300
600
1200
2400
4800
9600
19200
38400
57600
115200

An input of '000000' means that the interface is off.

B003 Interface Functions X6

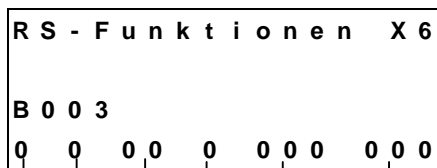

Reserved

Response delay in ms in RS485 Mode
000 = no delay

1 = in the event of a fault, an error message is sent automatically via the interface (RS 232 only).

0 = function disabled

Station number 01 - 32

Interface confirmation (Y CR LF)

0 = off

1 = on

Handshake / Checksum:

0 = checksum validation on

- hardware handshake RTS/CTS off

1 = checksum validation off

- hardware handshake RTS/CTS off

2 = checksum validation on

- hardware handshake RTS/CTS on

3 = checksum validation off

- hardware handshake RTS/CTS on

If the checksum validation is off, transmission of the checksum can be skipped. In this case, 'CR LF' is sufficient instead of '\$hh CR LF.'

Interface Confirmation 0 = confirmation disabled
1 = confirmation enabled

Data input of program and parameter sets via the serial interface is monitored. If erroneous data are present, an error message is sent via the serial interface.

If interface confirmation is selected and if the CLM has completely and correctly received and performed calculations for a program or parameter set, 'Y CR LF' is sent via the serial interface as a confirmation.

Description of All Characters Used in the Data String

First Control Character in the Data String:

The first control character indicates the beginning of a data transmission:

1) **?** Hexadecimal 3F / character for data query

If the control receives a `?`, the requested information (program instruction, parameter, status message) is output.

2) **#** Hexadecimal 23 / characters for program transmission

If the CLM receives a `#`, the following characters are read into the corresponding instruction number of the program memory.

3) **!** Hexadecimal 21

If the control receives a `!`, the following characters are picked up as the control command or as parameter data.

4) **:** Hexadecimal 3A

Colon for polling query

Second Control Character in the Data String:

S This character identifies the station number. The 's' is to be replaced by an appropriate character, depending on the operating mode.

1) In RS232C operating mode, the `s` is replaced by a blank space. No other character is accepted.

2) In RS485 mode, the `s` is replaced by the respective station number (1 -9; A - W). If this number does not correspond to the number in the parameter (see Parameter B003), there is no response to the received data.

If `s` is a blank space, this information is relevant for all users on the bus.

Third Control Character: The third character identifies the information type:

1) **N**
Hexadecimal 4E / character for instruction number

The information following the `N` is interpreted as a program instruction.

2) **K** Hexadecimal 4B / character for parameter

The information following the `K` is interpreted as a parameter.

3) **X** Hexadecimal 58 / character for status

4) **P** Hexadecimal 50 / character for Logic Task

The information following the `P` is interpreted as a Logic Task instruction.

- 5) **V** Hexadecimal 5 6 / character for variable
The information following the `V` is interpreted as a variable.

Other Control Characters:

- 1) **\$** Hexadecimal 2 4 / character for checksum
2) **hh** Hexadecimal value / checksum

These two characters represent the result of the checksum for a piece of information. The checksum is sent by the CLM along with each type of information. When data is received, the checksum can be disregarded.

- 3) **CR** Hexadecimal 0 D / character for carriage return
(Carriage Return)
LF Hexadecimal 0A / character for line-feed

The characters `CR` and `LF` together, form the end of each transmission.

Information Characters: All information characters are coded hexadecimally. The following characters are used to exchange information:

- 1) **0** through **9** Hexadecimal 3 0 through 3 9
A through **Z** Hexadecimal 4 1 through 5 A

The numerals `0` through `9` and the letters `A` through `Z` are available for command and data input.

- 2) **—** hexadecimal 2 0 / space (space bar)

To produce the desired format, the space is used at various points within the data string.

- 3) **+** Hexadecimal 2 B / Operational sign for data
- Hexadecimal 2 D / Operational sign for data

- 4) **.** Hexadecimal 2 E
, Hexadecimal 2 C

When numerical values are received, the CLM accepts both a period and a comma. Both are accepted as the decimal point. For numerical values, a decimal point is always sent by the CLM.

Software Handshake:	X-ON	Hexadecimal 1 1
	X-OFF	Hexadecimal 1 3

The data flow is controlled with a software handshake.

When the CLM sends data via the 'TxD' channel and receives an 'X-OFF' signal (hexadecimal 13) via the 'RxD' channel, the CLM interrupts the transmission until another 'X-ON' signal (hexadecimal 11) is received via the 'RxD' channel.

If the CLM receives data via the 'RxD' channel and an interruption of the data transmission is necessary, the CLM sends an 'X-OFF' signal via the 'TxD' channel.

If the transmission can be continued, the CLM sends an 'X-ON' signal via the 'TxD' channel.

Generating the Checksum

- Examples: 1. #_N0000_POI_1_123456.789_123_\$
 2. #5N0123_NOP__\$

Character	Hex	Σ Hex	Character	Hex	Σ Hex
#	23	23	#	23	23
_	20	43	5	35	58
N	4E	91	N	4E	A6
0	30	C1	0	30	D6
0	30	F1	1	31	107
0	30	121	2	32	139
0	30	151	3	33	16C
_	20	171	_	20	18C
P	50	1C1	N	4E	1DA
O	4F	210	O	4F	229
I	49	259	P	50	279
_	20	279	_	20	299
1	31	2AA	_	20	2B9
_	20	2CA			
_	20	2EA			
_	20	30A			
_	20	32A			
+	2B	355			
1	31	386			
2	32	3B8			
3	33	3EB			
4	34	41F			
5	35	454			
6	36	48A			
.	2E	4B8			
7	37	4EF			
8	38	527			
9	39	560			
_	20	580			
1	31	5B1			
2	32	5E3			
3	33	616			
_	20	636			

Fig. 9-12: Generating the Checksum

- The sum of all 'ASCII' characters is calculated, from the first control character to the last character before the '\$'.
- Then, the 'High Byte' is added to the 'Low Byte.' A transmission occurring during this time is ignored.
- The Two's Complement of the 'Low Byte' of this sum results in the checksum

Example 1: #_N0000_1_123456.789_123_ \$C4

Sum: 636 → 06 + 36 = 3C. The Two's Complement of 3C is C4.

Example 2: #5N0123_NOP__\$45

Sum: 2B9 → 02 + B9 = BB. The Two's Complement of BB is 45.

Data Transmission

Program Transmission

Transmit Program Instructions to the CLM:

A new instruction is read in as shown in the example below.
 The character sequence `# s N` always comes first.
 An entry must always be concluded with `CR LF`.

Format:

```
# s N b b b b _ c c c _ d d d d d d d d d d d d d d d d _ $ h h CR LF
```

Meaning of the characters used:

- s = Blank space for RS232C or station number for RS485
- b = Instruction number
- c = Command code
- d = Instruction information (data field with up to 32 characters)

Examples of data transmissions to the CLM:

```
# _ N 0 1 0 0 _ P O I _ 1 _ _ _ _ + 1 2 3 4 5 6 . 7 8 6 _ 1 2 3 _ $ C 6 CR LF
# _ N 0 1 0 1 _ A E A _ Q 1 . 0 0 . 3 _ 1 _ $ C 0 CR LF
# _ N 0 1 0 2 _ B P A _ 0 1 2 3 _ M 2 . 0 2 _ _ _ _ _ 2 1 1 1 2 2 1 2 _ $ 3 2 CR LF
```

The data formats are stipulated for each command and must be complied with!

Command	Data	Data
ACC	ACC_1_ _ _ _ 234_ _ 567_	ACC_V602_V600_V601_
AEA	AEA_Q1.01.1_1_ _ _ _	AEA_Q1.01.0_V600_
AEO	AEO_1_ _ _ _ 1_1_ _ 500_ _ 100_	AEO_V600_1_1_ V601_V602_
AKN	AKN_M1.02.3_1_ _ _ _	AKN_M2.02.3_V600_
AKP	AKP_M2.02_01201201_	AKP_M2.02_01201201_
APE	APE_Q0.01_01201201_	APE_Q0.01_01201201_
BAC	BAC_1234_-5678_98765_	BAC_V600_-5678_V601_ _
BCE	BCE_0234_I0.12.3_ _ _ _ 1_ _ _ _	BCE_V601_I1.01.3_ _ _ _ V600_
BIC	BIC_0234_56_ _ _ _ _ M0.12.3_0_1_	BIC_V601_V600_ _ _ _ _ M0.12.3_0_1_
BIO	BIO_0234_M2.03_Q0.56_01201201_	BIO_V600_M2.03_Q0.01_01201201_
BPA	BPA_0234_M2.02_ _ _ _ _ 01201201_	BPA_V600_M2.02_ _ _ _ _ 01201201_
CID	CID_V600_1_ _ _ _ _ +12345.678_	CID_V600_1_ _ _ _ _ +V601_
CIO	CIO_M2.02.3_Q0.01.1_45_ _ _	CIO_M2.02.3_Q0.01.1_V600_ _
CLC	CLC_0234_	CLC_V600_
CON	CON_1_ _ _ _ 1_ _ _ _ +234_ _	CON_V602_V600_ +V601_
COU	COU_+12345_Q0.01.1_ _ 654321_	COU_+12345_Q0.01.1_ _ V600_ _ _
CPJ	CPJ_V600>=+12345.678_1234.56_1234_	CPJ_V604_ =+V600_ _ _ _ _ V601_ _ _ _ V603_
CPL	CPL_1_ _ _ _	CPL_V600_

CPS	CPS_V602<=+12345.678 1234.56_Q0.01.1_	CPS_V602_<+V600_ _ _ _ _ V601_ _ _ _ _ Q0.01.1_
CST	CST_1_2_	CST_1_2_
CVT	CVT_V600_M2.02_3_1_	CVT_V600_M2.02_3_1_
FAK	FAK_1_ _ _ _ 1.654321_	FAK_V601_V600_ _ _ _ _
FOL	FOL_1_ _ _ _ 1_ _ _ _ _ +12.654321_	FOL_V601_V602_ _ _ _ _ +V600_ _ _ _ _
HOM	HOM_1_ _ _ _	HOM_V600_
JMP	JMP_0234_	JMP_V600_
JSR	JSR_0234_	JSR_V600_
JST	JST_0234_	JST_V600_
JTK	JTK_0234_3_	JTK_V600_3_
MAT	MAT_V600_=_V656_- _ _ _ +123456.987654_	MAT_V123_=_V456_- _ _ _ +V600_ _ _ _ _
NOP	NOP_	NOP_
PBK	PBK_1_ _ _ _	PBK_V600_
POA	POA_1_ _ _ _ +123456.789_123_ _	POA_V602_+V600_ _ _ _ _ V601_
POI	POI_1_ _ _ _ -123456.789_123_ _	POI_V602_- V600_ _ _ _ _ V601_
PSA	PSA_1_ _ _ _ +123456.789_123_ _	PSA_V602_+ V600_ _ _ _ _ V601_
PSI	PSI_1_ _ _ _ +123456.789_123_ _	PSI_V602_+ V600_ _ _ _ _ V601_
REP	REP_0234_1_ _ _ _ _ 123456.789_	REP_V601_V602_ _ _ _ _ V600_ _ _ _ _
RMI	RMI_1_2_I1.00.1_	RMI_1_2_I1.00.1_
RSV	RSV_1_ _ _ _ 0234_12345_	RSV_1_ _ _ _ V600_12345_
RTM	RTM_1_ _ _ _ 1_ _ _ _	RTM_V601_V600_
RTS	RTS_	RTS_
SAC	SAC_1_ _ _ _ 1_ _ _ _ _ +123456.789_	SAC_V600_1_ _ _ _ _ +V601_ _ _ _ _
SET	SET_V600_=_ _ _ _ _ +12345678.123456_	SET_V601_=_ _ _ _ _ +V600_ _ _ _ _ _ _ _ _ _
SRM	SRM_1_ _ _ _ +123456.123_+123_ _I0.00.6_	SRM_V602_+V600_ _ _ _ _ +V601_ _I0.00.6_
VCC	VCC_1_ _ _ _ +123456.789_123_ _0_1_ _ _	VCC_V603_+V600_ _ _ _ _ V601_0_V602_
VEO	VEO_1_ _ _ _ 1_1_123_ _1_	VEO_V601_1_1_V600_ _1_
WAI	WAI_12.345_	WAI_V600_

Fig. 9-13: Transmission Formats of the Commands

Read Program Instructions Out of the CLM:

Example of querying an instruction from the CLM:

Format:

```
? s N b b b b $ h h C R L F
```

The character sequence `? s N` always comes first. An entry must always be concluded with `C R L F`.

In response to this query, the CLM sends the contents stored in the queried program instruction `b b b b`.

```
# s N b b b b _ c c c _ d d d d d d d d d d d d d d d d _ $ h h C R L F
```

Meaning of the characters used:

- s = Blank space for RS232C or station number for RS485
- b = Instruction number
- c = Command code
- d = Instruction information (data field with up to 32 characters)

Readout of Parameters

Read Parameters Out of the CLM:

Parameters can be read out in any operating mode.

Format:

```
? s K _ x x y y C R L F
```

In response to this query, the CLM sends the contents stored in the queried parameter `x x y y`.

```
K s x x y y _ d d d d d d d d _ $ h h C R L F
```

Meaning of the characters used:

- x = Parameter instruction identifier
- y = Parameter number
- d = Instruction information (data field with up to 16 characters)

Parameter Instruction	Identifier	Parameter Number
General	B 0	00 to 19
Axis 1	A 1	00 to 34
Axis 2	A 2	00 to 34
Axis 3	A 3	00 to 34
Axis 4	A 4	00 to 34
Master Encoder	C 0	00 to 07

Examples:

Query	Response
? _ K _ A 1 0 0 C R L F	K_A100_1_0_0_0_0 _ _ _ _ _ \$ 4 F C R L F
? _ K _ B 0 0 3 C R L F	K_B003_0_0_00_0_000_000\$ E C R L F

Variables Readout of a Variable

Variables can be read out in any operating mode.

Format:

```
?sVxxx_$hh CR LF
```

In response to this query, the contents stored in the queried variable 'xxx' are sent.

```
Vsxxx_+12345678.123456_$hh CR LF
```

Meaning of the characters used:

- x = Variable number
- h = Checksum

Writing a Variable

```
#sVxxx_+ddddddd.ddddddd_$hh CR LF
```

Meaning of the characters used:

- x = Variable number
- h = Checksum
- d = Variable information

Logic Task: Logic Task instructions can be read out in any operating mode.

Format:

```
?sP_xxxx_$hh CR LF
```

In response to this query, the contents stored in the queried Logic Task instruction 'xxxx' are sent.

```
Psxxx_dddddddd_$hh CR LF
```

Meaning of the characters used:

- x = Logic Task instruction number
- d = Instruction information (data field with up to 16 characters)

Writing a Logic Task assignment

```
#sPxxx_dddddddd_$hh CR LF
```

Meaning of the characters used:

- x = Logic Task instruction number
- d = Instruction information (data field with up to 16 characters)

Readout of Status Information

The following status messages can be queried for each status request via the serial data interface:

Status `00`	=	Actual position of Axes 1 and 2 in IU
Status `01`	=	Transmission error, interface
Status `02`	=	Current program instruction number, Task 1
Status `03`	=	Actual position of Axes 1 and 2 in increments (Hexadecimal)
Status `04`	=	Counter
Status `05`	=	Software version
Status `08`	=	Current instructions and return instruction numbers of tasks 1 through 3
Status `09`	=	Measuring wheel mode: actual position of Axis 1 and position of motor encoder
Status `10`	=	Position lag of Axes 1 and 2 in IU
Status `19`	=	Hardware and software versions
Status `39`	=	Current instructions and return instruction numbers for Tasks 4 and 5
Status `40`	=	Actual position of Axes 3 and 4 in increments
Status `41`	=	Actual position of Axis 1 by reference marker
Status `42`	=	Actual velocity of Axes 3 and 4 in 1/min
Status `43`	=	Position lag of Axes 3 and 4 in IU
Status `44`	=	Actual position of Axes 3 and 4 in IU
Status `45`	=	Voltage at analog inputs 3 and 4
Status `47`	=	Actual velocity of the measuring wheel encoder
Status `48`	=	Actual velocity of Axes 1 and 2 in 1/min
Status `49`	=	Voltage at analog inputs 1 and 2
Status `53`	=	Fault indication
Status `61`	=	Output of a byte M/I/Q

Status `00` Actual position of Axes 1 and 2 in IU

The status query:

```
?sX__00_ CR LF
```

produces the message:

```
Xs00_evmmmmm.mmm_evnnnnnn.nnn_$hh CR LF
```

Meaning of the characters used:

- e = ` ` stands for relative position (not homed)
- `A` stands for absolute position (axis homed)
- v = Operational sign of the actual position
- m = Actual position of Axis 1 in IU
- n = Actual position of Axis 2 in IU

Status `01` Transmission error

The CLM sends this status information automatically if an error occurs in the transmission. Status 01 can *not* be queried.

In the event of a transmission error, the CLM delivers the following message:

```
Xs01_ff_ttttttttttttttttttttt_$hh CR LF
```

Meaning of the characters used:

- f = Fault (error) number
- t = Fault (error) text (always 20 characters)

Below is a list of the fault (error) numbers and their meanings:

Fault No.	Fault Text	Description
01	RS Block # Wrong	Incorrect characters in the instruction number. The transmitted instruction number is not a decimal number.
02	RS Format Error	The format of the transmitted data is incorrect
03	RS Block Data Error	The transmitted instruction data are incorrect.
04	RS Checksum Error	The transmitted checksum is incorrect.
05	Invalid Mode	An attempt was made to transmit parameter data to the CLM. The control was not in 'Parameter' operating mode at the time.
06	Wrong RS Param #	The transmitted parameter number is not a decimal number.
07	Param. # too large	The transmitted parameter number is too large.
08	Wrong RS Status #	The number given in a status request is not a decimal number.
09	Status # illegal	An attempt was made to query status information that was not present.
10	M-Wheel Param Error	The measuring wheel parameters have not been set (e.g. for Status Numbers 46 and 47).
11	Invalid Param. Block	Incorrect parameter instruction identifier.
12	Block # too large	The transmitted instruction number is greater than 2999.
13	Invalid Prg Command	An invalid command was transmitted to the CLM.
16	Value too large	
18	Not accepted!	
23	Wrong Variable #	
25	Invalid Operand	

Status `02` current program instruction number (valid only for Task 1)

The status query:

```
?sX__02_ CR LF
```

produces the message:

```
Xs02_nnnn_uuuu_$hh CR LF
```

Meaning of the characters used:

- n = Current instruction number with four places, decimal
- u = Instruction number after the first 'JSR' command in the main program

Status `03` actual position of Axes 1 and 2 in increments

The status query:

```
?sX__03_ CR LF
```

produces the message:

```
Xs03_000C14FA_000A39CD_$$$$$hh CR LF
```

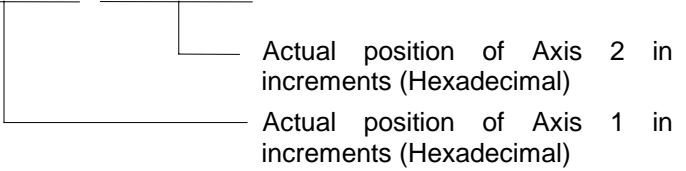

The actual position in IU is calculated as follows:

1) Example for incremental encoders:

Parameter A119 = 01500_0000
 Parameter A101 = 0010.00000

From these, the actual position in increments, hexadecimally represented as '000C14FA,' is calculated. This corresponds to a decimal value of '791802.'

$$\text{Actual position in IU} = \frac{\text{Actual Position in Increments} \times \text{Parameter A101}}{\text{Parameter A119} \times 4}$$

$$\text{Actual position} = \frac{791802 \times 10.0000}{1500 \times 4} = 1319,67 \text{ IU}$$

L: IU = input units
 Fig. 9-17: Calculation of the Actual Position with an Incremental Encoder

2) Example for absolute encoders:

Parameter A119 = 04096_0512
 Parameter A101 = 0020.00000

From these, the actual position in increments, hexadecimally represented as '000A39CD,' is calculated. This corresponds to a decimal value of '670157.'

$$\text{Actual Position in IU} = \frac{\text{Actual Position in Increments} \times \text{Parameter A101}}{\text{Resolution from Parameter A119}}$$

$$\text{Actual Position} = \frac{670157 \times 20.0000}{4096} = 3272,25 \text{ IU}$$

L: IU = input units
 Fig. 9-18: Calculation of the Actual Position with an Absolute Encoder

Status `04` Counter

The status query:

```
?sX__04_nnnn_CR LF
```

produces the message:

```
Xs04_nnnn_iiii_zzzzzz_____ $hh CR LF
```

Meaning of the characters used:

n = Block number
i = Actual quantity
z = Preset count

If the requested instruction contains no counter, blank spaces `_` are output for `i` and `z`.

Status `05` Software Version

The status query:

```
?sX__05_CR LF
```

produces the message:

```
Xs05__vvvvvvvvvvvvvvvvv_ $hh CR LF
```

Meaning of the characters used:

v = software version (also appears on the display of the CTA)

Status `08` Current instruction number and return instruction number to the main program of the 3 tasks

The status query:

```
?sX__08_CR LF
```

produces the message:

```
Xs08_aaaa_bbbb_cccc_dddd_eeee_ffff_ $hh CR LF
```

Meaning of the characters used:

a = Task 1 - Current instruction number
b = Task 1 - Instruction number of the main program
c = Task 2 - Current instruction number
d = Task 2 - Instruction number of the main program
e = Task 3 - Current instruction number
f = Task 3 - Instruction number of the main program

In the case of tasks that have not been activated, an appropriate number of blank spaces is output.

If a task is not located in a subroutine, only the current instruction number is output.

Status `09` Measuring wheel mode: Actual position of Axis 1 and position of motor encoder

The status query:

```
?sX__09_CR LF
```

produces the message:

```
Xs09__evmmmmm.mmm_vnnnnnn.nnn_$hh CR LF
```

Meaning of the characters used:

- e = ` ` stands for relative position (not homed)
- `A` stands for absolute position (axis homed)
- v = Operational sign of the actual position
- m = Actual position of Axis 1 in IU. The sums of all Measuring wheel encoder movements are added
- n = Actual position of the motor encoder in IU (incremental encoder 1)

If Axis 1 is not homed, the displayed absolute position can be set to zero at any time by pressing 'CR' on the CTA.

Status `10` Axis 1 and 2 position lag (following error)

The status query:

```
?sX__10_CR LF
```

produces the message:

```
Xs10_vm m m m m . m m _ v n n n n n . n n n _ $ h h CR LF
```

Meaning of the characters used:

- v = Operational sign for position lag (following error)
- m = Position lag (following error) of Axis 1 in IU
- n = Position lag (following error) of Axis 2 in IU

Status `19` Hardware and software versions

The status query:

```
?sX__19_CR LF
```

produces the following message, e.g.,:

```
Xs19_CLM01.4-P-E-4-BCLM1.4-LAP-01V08$hh CR LF
```

software version
max. 16 characters

Hardware version
max. 16 characters

Status 19 provides the same information that is shown for the software version on the CLM display.

Status 19 provides the same information 'hardware/software version' for all CLM software versions. This way, the RS485 bus master can detect the software type of all connected controls.

Status `39` Current instruction number and return instruction number to the main program of Tasks 4 and 5

The status query:

```
?sX__39_CR LF
```

produces the message:

```
Xs39_aaaa_bbbb_cccc_dddd_$hh CR LF
```

Meaning of the characters used:

- a = Task 4 - Current instruction number
- b = Task 4 - Instruction number of the main program
- c = Task 5 - Current instruction number
- d = Task 5 - Instruction number of the main program

In the case of tasks that have not been activated, an appropriate number of blank spaces ` ` is output.

If a task is not located in a subroutine, only the current instruction number is output.

Status `40` Actual position of Axes 3 and 4 in increments

The status query:

```
?sX__40_ CR LF
```

produces the message:

```
Xs40_000C14FA_000A39CD_$$$$$hh CR LF
```

Actual position of Axis 4 in increments
(hexadecimal)

Actual position of Axis 3 in increments
(Hexadecimal)

The actual position in IU, when using an incremental or absolute encoder, is calculated as described in the examples for Status `03`.

Status `41` Actual position of Axis 1 by reference marker

The status query:

```
?sX__41_ CR LF
```

produces the message:

```
Xs41_evmmmmm.mmm_$$$$$hh CR LF
```

Meaning of the characters used:

- e = ` ` stands for relative position (not homed)
- `A` stands for absolute position (axis homed)
- v = Operational sign of the actual position
- m = Actual position of Axis 1 in IU

The following message issues the actual position of Axis 1 for the last raster.

The absolute actual position of Axis 1 is buffered to the raster input with a leading edge, using the 'SRM' command.

The last saved position can be read out at any time using Status 41.

The attainable accuracy is dependent on the delay between the signal at the raster input and the position detection by the CLM.

The delay is approximately 0 to 150 µs.

Status `42` Actual velocity of Axis 3 and 4

The status query:

```
?sX__42_CR LF
```

produces the message:

```
Xs42_1_+1234.56_1_+1234.56_$hh CR LF
```

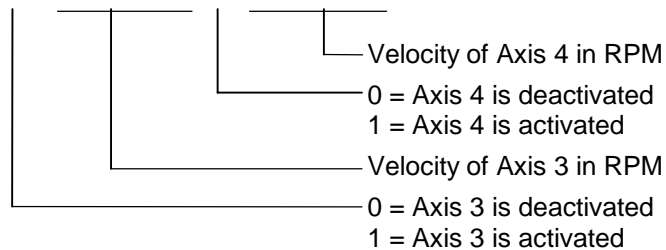

The velocity values that are output are average values (calculated over 32 control cycles).

Status `43` Axis 3 and 4 position lag (following error)

The status query:

```
?sX__43_CR LF
```

produces the message:

```
Xs43_vmmmmm.mmm_vnnnnnn.nnn_$hh CR LF
```

Meaning of the characters used:

- v = Operational sign for position lag (following error)
- m = Position lag (following error) of Axis 3 in IU
- n = Position lag (following error) of Axis 4 in IU

Status `44` Actual position of Axes 3 and 4 in IU

The status query:

```
?sX__44_CR LF
```

produces the message:

```
Xs44_evmmmmm.mmm_evnnnnnn.nnn_$hh CR LF
```

Meaning of the characters used:

- e = `_' stands for relative position (not homed)
`A' stands for absolute position (axis homed)
- v = Operational sign of the actual position
- m = Actual position of Axis 3 in IU
- n = Actual position of Axis 4 in IU

Status `45` Voltage at analog inputs 3 and 4

The status query:

```
?sX__45_CR LF
```

produces the message:

```
Xs45_+12345_+12345_$hh CR LF
```

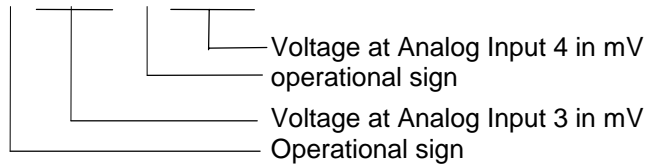

The analog inputs 1 and 2 can be requested via Status `49.`

Status `47` Actual velocity of the measuring wheel encoder

The status query:

```
?sX__47_CR LF
```

produces the message:

```
Xs47_0_+1234.56_$hh CR LF
```

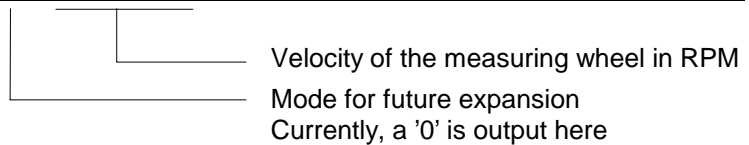

The velocity values that are output are average values (calculated over 32 control cycles).

When no measuring wheel encoder resolution is programmed in Parameter C000, in place of Status 47, Status 01 (Error Message 10: M-Wheel Param Error) is output.

Status `48` Actual velocity of Axis 1 and 2

The status query:

```
?sX__48_CR LF
```

produces the message:

```
Xs48_1_+1234.56_1_+1234.56_$hh CR LF
```

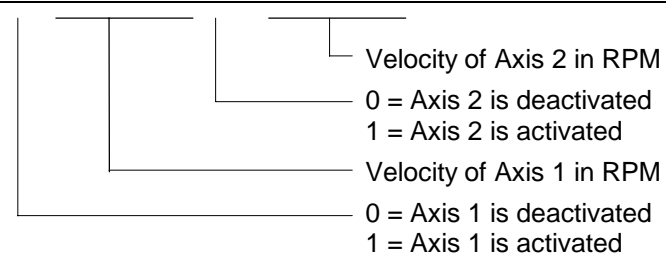

The velocity values that are output are average values (calculated over 32 control cycles).

Status `49` Voltage at Analog Inputs 1 and 2

The status query:

```
?sX__49_CR LF
```

produces the message:

```
Xs49_+12345_+12345_$hh CR LF
```

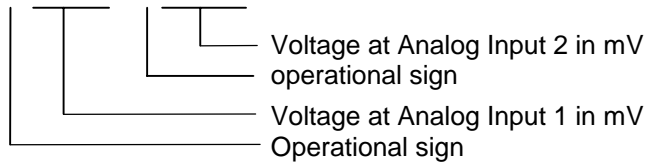

The analog inputs 3 and 4 can be requested via Status `45`.

Status `53` Error Message

The status query:

```
?sX__53_CR LF
```

produces the message:

```
Xs53_nn_tttttttttttt_$hh CR LF
```

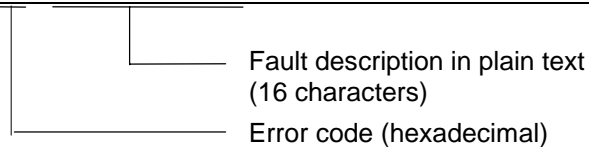

For error texts and codes, see Parameter B018 and Chapter Diagnostic Messages.

Status 61

Output of a byte M/I/Q

The status query:

```
?sX__61_mt.nn_CR LF
```

produces the message:

```
Xs61_mt.nn_bbbbbbbb_$hh CR LF
```

Bit 7 0

- m = Source type I / Q / M
- t = Source number
- n = byte number
- b = Bits

Interface Commands

For all commands, it is necessary for the checksum transmission to be independent of the programming in Parameter B003!

Program Start

```
!s START_ $hh CR LF
```

starts the program in Automatic Mode

Program Stop

```
!s STOP_ $hh CR LF
```

Immediately stops a running automatic program. A program that has been stopped in this way cannot be re-started via the 'Start' input (connector X3/Pin 4), but only via a START interface command.

Clear Fault

```
!s CLEAR_ $hh CR LF
```

Clears an error message

For the following commands, these points are valid:

- The axis is activated after a re-start (following power loss) and after an E-Stop!
- The current status of an axis (activated/deactivated) remains constant for:
 - all error messages
 - any change of operating mode AUTO/MANUAL/PARA.

Activate Axis x

```
!s MxON_ $hh CR LF
```

If the precondition is met, drive enable and the brake each have 24V.

Deactivate Axis x

```
!s MxOFF_ $hh CR LF
```

- Drive enable and Brake = 0V
- Axis-specific error messages deactivated

Meaning of the characters used:

x = Axis 1-4

Axes 1 to 4 are activated or deactivated via the serial interface with identical commands.

If the enable signal for a deactivated axis is lost, no error message is issued.

Polling Query

A query, in the shortest possible format, which cyclically polls all of the CLM controls connected to the RS485 bus.

The query:

```
:s CR LF
```

produces the message:

```
:snn CR LF
```

Meaning of the characters used:

s	=	Station Number (1 - W)
nn	=	error code (hexadecimal)

For a list of errors, see Chapter Parameter, Parameter B018

Notes

10 Command Communications

10.1 Profibus

Rexroth Indramat provides advanced drive technology with a user-friendly interface. This is how, for example, homing and jogging were defined as individual operating modes in the DriveCom product. Rexroth Indramat has provided this functionality (as also defined in the ProfiDrive) as bits in the control word, and thus can now offer an interface that is easier to use.

Setting the Slave Address

The slave address is set in Parameter B008.

Status at Delivery:

The CLM1.4 address is set to 00 at delivery.

Settable Addresses: Slave addresses 1-99 (decimal) are supported.

Depending on the fieldbus type, however, the following limitations exist:

Profibus DP address: **2 - 89 permitted**

Note: Slave address 0 does not exist and cannot be used in applications.

Slave Address The address is read from Parameter Mode to the operating mode when starting up the CLM, and it is used to set the parameters for the fieldbus. To set the slave address, parameter input X3/1 is used. This input is dominant and is used for the initial startup of the control.

The data channel size is 32 bytes.

Service Data Channel	Process Data Channel
6 Words	8 (7) Words

Fig. 10-1: Transmission

Fieldbus Parameters

Several parameters must be programmed for the fieldbus. The parameters are part of the group B0xx.

B006 Fieldbus Cycle Time

B007 Fieldbus Baudrate

B008 Fieldbus Format

Process Data Channel

O Channel (CLM Output)	Diagnostic Channel	Variable Channel
3 Words	1 Word	4 Words

Fig. 10-2: Transmit Channel

I Channel (CLM Input)	Variable Channel
3 Words	4 Words

Fig. 10-3: Receive Channel

I/O Channel The I/O Channel consists of 3 words. The Status Word and the Control Word are concretely defined. The other two words are not defined. Their function is assigned via the user program or the parameters.

I/O Status Word (CLM Output)

Bit Field	Definition	Designation
0	Manual Mode	Q2.00.0
1	Automatic Mode	Q2.00.1
2	Parameters	Q2.00.2
3	Drive Enable 1	Q2.00.3
4	Brake 1	Q2.00.4
5	Fault	Q2.00.5
6	Drive Enable 2	Q2.00.6
7	Brake 2	Q2.00.7
8	Reserved	Q2.01.0
9	Run	Q2.01.1
10	Reserved	Q2.01.2
11	Reserved	Q2.01.3
12	Reserved	Q2.01.4
13	Inhibit Operation	Q2.01.5
14	Drive Enable 3	Q2.01.6
15	Drive Enable 4	Q2.01.7

Fig. 10-4: CLM Status Word

I/O Control Word (CLM Input)

Bit Field	Definition	Designation
0	Parameter Mode	I2.00.0
1	Manual/Automatic	I2.00.1
2	Reserved	I2.00.2
3	Start	I2.00.3
4	Immediate Stop	I2.00.4
5	Reserved	I2.00.5
6	Reserved	I2.00.6
7	Clear Errors	I2.00.7
8	Jog Forward 1	I2.01.0
9	Jog Reverse 1	I2.01.1
10	Jog Forward 2	I2.01.2
11	Jog Reverse 2	I2.01.3
12	Reserved	I2.01.4
13	Reserved	I2.01.5
14	Restart	I2.01.6
15	Reserved	I2.01.7

Fig. 10-5: CLM Control Word

User-configurable I/O

CLM Input

I2.02

I2.03

I2.04

I2.05 are the addresses of the available words

CLM Output

Q2.02

Q2.03

Q2.04

Q2.05 are the addresses of the available words

Diagnostic Channel

The diagnostic (Status, Warning, Error Message) is made available in a word as a hexadecimal number. The content represents the diagnostic numbers assigned in the description.

Variable Channel

The length is 4 words, and all variables can be transmitted in 4 different formats.

From Master to CLM

Read Control Word	Write Control Word	Variable Datum
1 Word	1 Word	1 Long Word

Fig. 10-6: Variable Channel Master → CLM

1 Word: Read Control Word

1 Word: Write Control Word

1 Long: Variable Datum

From CLM to Master

Read Status Word	Write Status Word	Variable Datum
1 Word	1 Word	1 Long Word

Fig. 10-7: Variable Channel CLM → Master

1 Word: Read Status Word

1 Word: Write Status Word

1 Long: Variable Datum

Write Status Word / Read Status Word

Bits	Function
0 - 9	Variable Number
10 - 13	Format / Error Number
14	Error Bit
15	Handshake Bit toggles to the Status Word

Fig. 10-8: Status Word for Variable

Write Control Word / Read Control Word

Bits	Function
0 - 9	Variable Number
10 - 13	Format
14	Reserved (always 0)/ Version Number: 0
15	Handshake Bit toggles to the Status Word

Fig. 10-9: Control Word for Variable

Handshake Process

When restarting the CLM, the handshake bits are the same.

When the master makes a read or write request, the respective handshake bit must be toggled in the control word. After the CLM has processed the request, it toggles the respective handshake bit in the status word.

Handshake Bit Control Word	Handshake Bit Status Word	Status
0	0	No function
1	0	Request from the Master
1	1	Request processed by the Slave (CLM)
1	1	No function
0	1	Request from the Master
0	0	Request processed by the Slave (CLM)
0	0	No function

Fig. 10-10: Handshake Process

- The following data formats are defined
 - Format 0 = Integer (+/-99999999)
 - Format 1 = Fixed point (3) (+/-99999.999)
 - Format 2 = Fixed point (6) (+/- 99.999999)
 - Format 3 = IEEE Floating point (in development)
- When the error bit (Bit 14) is set in the status word, error numbers are assigned to the format bits (Bits 10-13). The following error numbers are assigned:
 - Error 0 = Variable number too large
 - Error 1 = Variable number illegal
 - Error 2 = Unknown format
 - Error 3 = Datum too large
 - Error 4 = Datum too small
 - Error 5 = Datum not displayable (IEEE)
 - Error 6 = Variable not writable
 - Error 7 = Bit 14 = 1

Variable Number:

Assignment of the variables as in the description

Variables V600 – V999 are available.

Service Data Channel

In preparation

In the future, instructions, parameters and the logic task will be transmitted via this channel.

Parallel Interface

The following hardware inputs must be assigned to the CLM:

- Parameters X3/1
- E-Stop X3/3
- Enable 1 X3/6
- Enable 2 X3/7 (only when Axis 2 present)
- Enable 3 X22/1
- Enable 4 X22/4

Assignment of Profibus Connector X30

Signal Assignment for X30 Profibus Connector

X 30	RS 485 Reference	Rexroth Indramat Signal Name	Signal according to EN50170 Volume 2	Definition
1		PE	Shield	Shield or Protective Ground
2		unused		
3	B / B´	B	RxD / TxD-P	Receive/Transmit Data - P
4		CNTR-P	CNTR-P	Repeater – Control Signal P
5	C / C´	BUSGND	DGND	Data Ground
6		VP	VP	Supply Voltage - Plus (P5V)
7		unused		
8	A / A´	A	RxD / TxD-N	Receive/Transmit Data - N
9		CNTR-N	CNTR-N	Repeater - Control Signal N

Fig. 10-11: X30 Signal Assignment. Profibus-DP

Profibus LED Diagnostic

For diagnosing the Profibus interface, four LEDs are available on the front of the fieldbus card. These LEDs signal the status of the synchronization between the fieldbus interface and the control, as well as the bus activity for the cyclic data exchange.

LED Designation	LED Status	Definition
H30	ON	Cyclic Process Data channel is active
H31	--	--
H32/33	alternately blinking	synchronization between the fieldbus card and the CLM established
H32/33	blinking simultaneously	synchronization between the fieldbus card and the CLM established
all LEDs	blinking simultaneously	serious error in the fieldbus card. Turn unit off / on

Fig. 10-12: Diagnostic LEDs for Profibus X30

Notes

11 Diagnostic Messages

11.1 General Information about Error Identification

If the CLM detects an error, it shows the reason for the error on the display.

After clearing the error, the CLM must be restarted. This can be accomplished by pressing  on the display or by using an external 'Clear' command.

11.2 Error Code Numbers

Every error message has a hexadecimal code number. The customer can read this number via the RS interface or via outputs.

Following is an overview of code numbers and their assignment to error messages:

Code Number	Assignment
00 to 3F	General Error
40 to 6F	Axis 1 Errors
70 to 9F	Axis 2 Errors
A0 to CF	Axis 3 Errors
D0 to FF	Axis 4 Errors

Fig. 11-1: Assignment of Error Codes

Following is a list of code numbers and their meanings when an error occurs:

Hex Code	Error	Page
00	No Error, Manual or Automatic Mode	11-5
01	No Error; Parameter Mode	11-5
02	Parameter XXXX (the affected parameter)	11-5
03	EMERGENCY STOP	11-5
04	Battery is low !	11-6
05	Parameters Lost	11-6
06	Program Lost	11-6
07	Division by Zero	11-6
08	Invalid Mode !	11-6
0A	Invalid Prg Cmd	11-7
0B	JSR Nesting	11-7
0C	RTS Nesting	11-7
0D	BCD Input Error	11-7
0E	Invalid Block #	11-8
10	(System Failure) Code #EXCPXX ('Exception')	11-8
11	(System Failure) Code #STKOVF ('Stack overflow')	11-8
11	(System Failure) Code #IRQOVL ('IRQ too long')	11-9
11	(System Failure) Code #EPROM ('EPROM')	11-9
12	IDS Break-Error	11-9
13	IDS Checksum Err	11-9
14	IDS Char Format	11-10
16	Wrong Axis No.	11-10
17	Hardw. Axis 3&4	11-10
19	CLM \pm 15 Volts	11-10
1A	REP – Command (not possible)	11-11
1B	SAC – Command (not possible)	11-11
1D	Command I/O	11-11
2C	Inc.Enc.1 faulty	11-11
2D	Inc.Enc.2 faulty	11-11
2E	Inc.Enc.3 faulty	11-11
2F	Inc.Enc.4 faulty	11-11
30	Inc.Enc.5 faulty (measuring wheel encoder)	11-11
31	Write Sys.-Var.	11-12
32	Variable value	11-12
33	Fieldbus	11-12
34	Fieldbus Init	11-12
35	Missing EOS Cmd	11-13
36	Not Homeposition	11-13
37	Fieldbus Timeout	11-13
38	Logic Prg Error (Logic Task)	11-13
39	Logic Prg Lost (Logic-Task)	11-13

Hex code	Error	Page
40	Drive1 not Ready	11-14
41	FeedAngle Loss 1	11-14
42	Drive Runaway A1	11-14
43	Excess Pos Lag 1	11-15
44	Abs. Enc. Error1	11-15
45	Abs.Range Error 1	11-16
46	Min Travel Lmt 1	11-16
47	Max Travel Lmt 1	11-16
48	Axis 1 Not Homed	11-17
49	Cam too short 1	11-17
4A	No Marker Pulse1	11-17
4B	MrkrPulse Pos A1	11-17
4C	Encoder Fault A1 (Measuring wheel)	11-18
4D	Max. Override A1	11-18
4E	A1 not enabled	11-18
4F	Marker high A1	11-19
50	Target Pos <Lim1	11-19
51	Target Pos >Lim1	11-19
52	HOM - Command A1 (not possible)	11-19
70	Drive2 not Ready	11-14
71	FeedAngle Loss 2	11-14
72	Drive Runaway A2	11-14
73	Excess Pos Lag 2	11-15
74	Abs. Enc. Error2	11-15
75	Abs.Range Error2	11-16
76	Min Travel Lmt 2	11-16
77	Max Travel Lmt 2	11-16
78	Axis 2 Not Homed	11-17
79	Cam too short 2	11-17
7A	No Marker Pulse2	11-17
7B	MrkrPulse Pos A2	11-17
7D	Max. Override A2	11-18
7E	A2 not enabled	11-18
7F	Marker high A2	11-19
80	Target Pos <Lim2	11-19
81	Target Pos >Lim2	11-19
82	HOM - Command A2 (not possible)	11-19

Hex code	Error	Page
A0	Drive3 not Ready	11-14
A1	FeedAngle Loss 3	11-14
A2	Drive Runaway A3	11-14
A3	Excess Pos Lag 3	11-15
A4	Abs. Enc. Error3	11-15
A5	Abs.Range Error3	11-16
A6	Min Travel Lmt 3	11-16
A7	Max Travel Lmt 3	11-17
A8	Axis 3 Not Homed	11-17
A9	Cam too short 3	11-17
AA	No Marker Pulse3	11-17
AB	MrkrPulse Pos A3	11-17
AD	Max. Override A3	11-18
AE	A3 not enabled	11-18
AF	Marker high A3	11-19
B0	Target Pos <Lim3	11-19
B1	Target Pos >Lim3	11-19
B2	HOM - Command A3 (not possible)	11-19
D0	Drive4 not Ready	11-14
D1	FeedAngle Loss 4	11-14
D2	Drive Runaway A4	11-14
D3	Excess Pos Lag 4	11-15
D4	Abs. Enc. Error4	11-15
D5	Abs.Range Error4	11-16
D6	Min Travel Lmt 4	11-16
D7	Max Travel Lmt 4	11-16
D8	Axis 4 Not Homed	11-17
D9	Cam too short 4	11-17
DA	No Marker Pulse4	11-17
DB	MrkrPulse Pos A4	11-17
DD	Max. Override A4	11-18
DE	A4 not enabled	11-18
DF	Marker high A4	11-19
E0	Target Pos <Lim4	11-19
E1	Target Pos >Lim4	11-19
E2	HOM - Command A4 (not possible)	11-19

Fig. 11-2: Coded Error Messages

11.3 Error Descriptions

The following sections describe the error messages that appear on the CLM display.

General Error Messages

- Hex Code **00** = No Error Message
The CLM is in Manual or Automatic Mode.
- Hex Code **01** = No Error Message
The CLM is in Parameter Mode.

<p style="text-align: center;">I s I N V A L I D P a r a m e t e r A 1 0 0</p> <p>Mode A 1</p>
--

Hex Code **02**

This message appears when the value stored in a CLM parameter exceeds the minimum or maximum limits. The message appears on the first line of the display; the second line displays the number of the affected parameter.

- 1.The parameter containing the invalid input can be displayed by switching into Parameter mode and pressing the  key on the CLM keypad, or by providing +24 Vdc to the external Clear input (connector X3, pin 8).
- 2.Consult chapter parameter for the minimum and maximum limits of the parameter in which the error occurred.

<p style="text-align: center;">E R R O R E M E R G E N C Y S T O P</p>
--

Hex code **03**

The "EMERGENCY STOP" error occurs when +24 Vdc signal to the CLM Emergency Stop input is interrupted (connector X3, pin 3).

- 1.The Emergency Stop pushbutton has been pressed.
- 2.The Emergency Stop circuit has been broken. Consult the machine builder's wiring diagrams to determine what could have caused the break in the E-Stop circuit.
- 3.+24 Vdc has been applied to CLM connector X5, pins 1 and 2, but CLM connector X3 is not installed.
- 4.+24 Vdc must be applied to CLM connector X3, pins 36 and 37. Also, the reference (0 Vdc) must be applied to the CLM connector X3, pins 34 and 35.

E R R O R
B a t t e r y i s l o w !

Hex Code **04**

⇒ The battery is low and must be recharged. For this reason, the battery should be charged for at least 40 hours.

E R R O R
P a r a m e t e r s L o s t

Hex Code **05**

The contents of one or more parameters have been altered without new data input by the user.

⇒ The contents of all parameters must be checked.

Note: This error can be cleared automatically by exiting Parameter Mode.

E R R O R
P r o g r a m L o s t

Hex Code **06**

The contents of one or more program sets have been altered without new data input by the user.

⇒ The contents of all program sets used must be checked.

Note: This error appears only once, since a new checksum is calculated each time an error is cleared.

E R R O R
D i v i s i o n b y Z e r o

Hex Code **07**

contact the Indramat Service Department

The error is an internal software fault in the CLM. If this error occurs, all parameters must be checked for validity.

E R R O R
I n v a l i d M o d e !

Hex Code **08**

System inputs #1 and #2, Parameter and Automatic Mode, are on simultaneously. Check CLM display screen for status of system inputs.

ERROR
I n v a l i d P r g C m d

Hex Code **0A**

The error occurred because the CLM program encountered an invalid program command or the program command contains asterisks (*)
NOTE: If Task 3 is being used, enter the Task 3 program in the appropriate program block location, before enabling the Task 3 program in parameter B011. Refer to chapter programming to determine if the program command is used properly.

ERROR
J S R N e s t i n g

Hex Code **0B**

This nesting error occurs if the nesting depth of the programmed subroutines is greater than 127. Change the user program so that the number of nested subroutines does not exceed 127.

ERROR
R T S N e s t i n g

Hex Code **0C**

This nesting error occurs when an RTS command is encountered in the CLM program without a matching JSR command. Refer to chapter programming for information on the JSR and RTS commands. Verify in the CLM user program that a JSR command appears before the RTS command is encountered.

ERROR
B C D I n p u t E r r o r

Hex Code **0D**

This error will occur if a BIC command is encountered in the user program and the auxiliary inputs are not in a BCD format. Refer to chapter programming for information on the BIC command.

1. The BIC program command is programmed incorrectly.
2. Verify auxiliary inputs 1 through 8 are in a BCD format.

E R R O R I n v a l i d B l o c k #
--

Hex Code **0E**

The program contains a jump or branch command that causes the CLM user program to jump to a program block greater than 2999. **NOTE:** If Task 3 is being used, enter the Task 3 program in the appropriate program block location before enabling the Task 3 program in parameter B011.

1. The BIC program commands can result in a jump or branch to a target block greater than 2999. This jump is caused by a combination of an offset, jump distance, or binary input. Refer to chapter programming to determine if the program command is used properly.
2. The branch or jump command contains an asterisk (*) in the target block. Refer to chapter programming to determine if the program command is used properly.



S y s t e m F a i l u r e ! C o d e # E X C P X X
--

Hex Code **10**

A significant error occurred.

⇒ The external wiring must be checked.

Note: If this error has not yet been cleared using the  key, more details can be specified for troubleshooting by Customer Service. To do this, proceed as follows:

- 1) Press  on the CLM keypad.
 - 2) Take note of the code 'XX.'
 - 3) Take note of all information that appears by pressing the  or  keys.
 - 4) Clear the error.
 - 5) Take note of the firmware version that appears on the CLM display.
-

S y s t e m F a i l u r e ! C o d e # S T K O V F
--

Hex Code **11** - Contact INDRAMAT Customer Service! -

Serious internal error. Stack overflow, pseudo exception.

⇒ A firmware error may be present.

S y s t e m F a i l u r e ! C o d e # I R Q O V L	Hex Code 11
--	-------------

Serious internal error. Interrupt overlap, pseudo exception.

⇒ The internal timing of the CLM has been exceeded. The cycle time in Parameter B010 may need to be incremented by one.

S y s t e m F a i l u r e ! C o d e # E P R O M	Hex Code 11 - Contact INDRAMAT Customer Service! -
--	--

Serious internal error. Loss of EPROM data, pseudo exception.

⇒ The data in the EPROM have changed. Operation is impossible. The EPROM must be replaced.

E R R O R I D S B r e a k - E r r o r	Hex Code 12
--	-------------

This error will occur if the optional IDS board is enabled, but the CLM does not detect the connection of the IDS board.

The IDS board is enabled in parameter B002.

1. The cable between the IDS board and the CLM connector X6 is not installed properly.
2. The CLM serial communication port is defective.
3. The IDS board is defective.

E R R O R I D S C h e c k s u m E r r	Hex Code 13
--	-------------

This error will occur if the optional IDS board is enabled, but the CLM does not detect the connection of the IDS board.

The IDS board is enabled in parameter B002.

1. The cable between the IDS board and the CLM connector X6 is not installed properly.
2. If the IDS board is connected, then the wiring and its layout to the decade switch should be checked. Maximum cable length is 15m.

ERROR IDS Char Format
--

Hex Code **14**

This error will occur if the optional IDS board is enabled, but the CLM does not detect the connection of the IDS board.

The IDS board is enabled in parameter B002.

1. The cable between the IDS board and the CLM connector X6 is not installed properly.
2. If the IDS board is connected, then the wiring and its layout to the decade switch should be checked. Maximum cable length is 15m.

ERROR Wrong Axis No.

Hex Code **16**

This error occurs because the CLM program encountered a program command with an illegal axis number.

ERROR Hardw. Axis 3 & 4
--

Hex Code **17**

The parameters for axis 3 or 4 are set but there is no 4 axis option available

ERROR CLM +/- 15 Volts

Hex Code **19** - Contact INDRAMAT Customer Service! -

This error is an internal hardware fault in the CLM. The internal 15 Volts power supply is defective.

ERROR REP - Command

Hex Code **1A**

The REP command is only allowed in combination with the SRM command.

ERROR SAC - Command

Hex Code **1B**

This error occurs if the CLM program encounters a SAC command with an illegal mode.

ERROR Command Inp / Out p
--

Hex Code **1D**

This error occurs if the CLM program encounters a program command with an illegal input, output or marker number.

ERROR Inc. Enc. x faulty

Hex Code **2C** = Incremental Encoder 1 - Axis 1Hex Code **2D** = Incremental Encoder 2 - Axis 2Hex code **2E** = Incremental Encoder 3 - Axis 3Hex code **2F** = Incremental Encoder 4 - Axis 4Hex code **30** = Incremental Encoder 5 - Measuring Wheel

The output signals of the incremental encoders are monitored by the CLM's electronic evaluation feature. If one or more of these signals are missing, this error message is issued.

⇒ Check the encoder.

⇒ Check the encoder cable.

⇒ Check the encoder cable wiring for any wiring error.

Note: Monitoring is only performed for encoders that have an assigned function.

ERROR Write Sys. - Var.
--

Hex Code **31** = Write attempt of an NC command to a variable < 600

ERROR Variable value

Hex Code **32** = Erroneous variable value during execution of the command

During the execution of a command, the content of a variable is accessed. The content is checked against correctly functioning values in the command:

too large
operational sign
integer value

ERROR Fieldbus xx
--

Hex Code **33** Fieldbus Hardware

xx:

- 0 = No Error
- 1 = Flash Erase Error
- 2 = Verify Error
- 3 = Programming Error
- 4 = Wrong Hardware
- 5 = Card Missing
- FF = Timeout

ERROR Fieldbus Init xx

Hex Code **34** Fieldbus Initialization

xx:

- 0 = No Error
- F0 = Timeout, Initialization command could not be transmitted.
- F1 = Timeout, Initialization command was not acknowledged.
- F2 = Fieldbus Parameter Error
- F3 = No valid fieldbus data. Initialization command was not executed.

ERROR
M i s s i n g E O S C m d

Hex Code **35** = EOS command missing during "Flying Cutoff Operation"

The processing program did not end with the EOS command.

ERROR
N o t H o m e p o s i t i o n

Hex Code **36**

Error message during 'Flying Cutoff Operation.'
When switching to Automatic Mode, the carriage is not in its home position.

ERROR
F i e l d b u s T i m e o u t

Hex Code **37**

Cyclic transmission of the process data via the fieldbus is monitored. The CLM has not received a new telegram during the maximum cycle time (Parameter B006).

ERROR
L o g i c P r g . E r r o r

Hex Code **38** = Logic Task Program Error

1. An invalid command is programmed in the Logic Task.
2. An invalid input, output or flag number is programmed in the Logic Task.
3. No 'END' command is programmed in the Logic Task.
4. The positioning of the parentheses is wrong in the Logic Task.

ERROR
L o g i c P r g . L o s t

Hex Code **39** = Logic Task Program Lost

The contents of one or more Logic Task program sets have been altered without new data input by the user.

⇒ The contents of all Logic Task program sets must be checked.

Error Messages for Axes 1 to 4

The designation 'X' stands for the affected axis 1 through 4.

ERROR DriveX not Ready

Hex Code for

- Axis 1 = **40**
- Axis 2 = **70**
- Axis 3 = **A0**
- Axis 4 = **D0**

Automatic Mode is selected (Connector X3/Pin 2) and the input signal 'DriveX Ready' is missing.

ERROR FeedAngle Loss X

Hex Code for

- Axis 1 = **41**
- Axis 2 = **71**
- Axis 3 = **A1**
- Axis 4 = **D1**

This error occurs if the Feed Angle auxiliary input designated in parameter Ax15 goes low while the axis is moving.

ERROR Drive Runaway AX

Hex Code for

- Axis 1 = **42**
- Axis 2 = **72**
- Axis 3 = **A2**
- Axis 4 = **D2**

The position control loop signals a positive feedback (see Parameter Ax14).

- ⇒ The designated direction for position detection (encoder) and/or for the analog output are opposite of the cable connection. Check cable connection and/or change designated direction in Parameter Ax21.
- ⇒ The axis was moved too far from its command position by external forces.
- ⇒ The cable connection of the analog output has been interrupted and the axis drifts from its command position.
- ⇒ The encoder resolution input in the control (Parameter Ax19) is smaller than the actual encoder resolution.
- ⇒ The relationship of maximum velocity/voltage (Parameter Ax12) does not correspond to the values of the drive controller.
- ⇒ The selected position monitoring window is too small for the application. The standard value is 10%.
- ⇒ The drive cannot reach the velocity command value and overshoots when the movement direction is changed.

ERROR
E x c e s s P o s L a g X

Hex Code for Axis 1 = **43**
 Axis 2 = **73**
 Axis 3 = **A3**
 Axis 4 = **D3**

The position control loop signals an excessive position lag (see Parameter Ax14).

- ⇒ The axis does not execute a started positioning command, because:
 - 1) the encoder cable is not connected
 - 2) the encoder cable is defective or the wrong cable
 - 3) the encoder is defective.
- ⇒ The cable connection of the analog output is interrupted.
- ⇒ The encoder resolution programmed in the control (see Parameter Ax19) is larger than the actual encoder resolution.
- ⇒ The relationship of maximum velocity/voltage (Parameter Ax12) does not correspond to the values of the drive controller.
- ⇒ The selected position monitoring window is too small for the application. The standard value is 10%.
- ⇒ The drive cannot reach the velocity command value, because:
 - 1) the motor has too little power
 - 2) the input for acceleration (see Parameter Ax08/Ax09) was set too high.
- ⇒ The signal 'Drive1 Controller Enable' does not reach the drive.

ERROR
A b s . E n c . E r r o r X

Hex Code for Axis 1 = **44**
 Axis 2 = **74**
 Axis 3 = **A4**
 Axis 4 = **D4**

The condition occurs if the axis absolute encoder is not connected, or the data transmission to the CLM is interrupted or incorrect.

1. The absolute encoder value stored in the Encoder Data parameter does not correspond to the encoder used on the back of the axis motor. Verify that the absolute encoder value stored in parameter corresponds to the absolute encoder value.
2. The axis absolute encoder cable is not connected to the CLM encoder connector or the axis absolute encoder cable is not connected to the axis motor.
3. The axis absolute encoder cable is defective or wired incorrectly.
4. The axis absolute encoder is defective.

ERROR A b s . R a n g e E r r o r X
--

Hex Code for

- Axis 1 = **45**
- Axis 2 = **75**
- Axis 3 = **A5**
- Axis 4 = **D5**

Values are outside the measuring range of the absolute encoder for Axis X. The value is less than the encoder value '0' or greater than the maximum number of encoder revolutions (see Parameter Ax19/Ax20).

⇒ Check the set encoder type (single turn or multi turn encoder).

Check the input value for 'Absolute Encoder Data Bits' in Parameter Ax20.

Caution: There are two different types of Stegmann encoders, type AG100MSSI!

- 1.) AG100MSSI 4096***512** - **21** data bits must be entered in Parameter Ax20.
- 2.) AG100MSSI 4096***4096** - **24** data bits must be entered in Parameter Ax20.

⇒ The maximum number of encoder revolutions is less than the number set in Parameter Ax19.

ERROR M i n T r a v e l L m t X
--

Hex Code for

- Axis 1 = **46**
- Axis 2 = **76**
- Axis 3 = **A6**
- Axis 4 = **D6**

This minimum travel error occurs in Automatic Mode, if the value stored in the Minimum Travel Limit parameter is exceeded.

1. The commanded position has exceeded the axis minimum travel limit.
2. Verify that the axis minimum travel limit parameter is correct

ERROR M a x T r a v e l L m t X
--

Hex Code for

- Axis 1 = **47**
- Axis 2 = **77**
- Axis 3 = **A7**
- Axis 4 = **D7**

This maximum travel error occurs in Automatic Mode, if the value stored in the Maximum Travel Limit parameter is exceeded.

1. The commanded position has exceeded the axis maximum travel limit.
2. Verify that the axis maximum travel limit parameter is correct.

E R R O R
A x i s X N o t H o m e d

Hex Code for Axis 1 = **48**
 Axis 2 = **78**
 Axis 3 = **A8**
 Axis 4 = **D8**

In the program, a command that requires an axis with an absolute reference point was invoked.

- ⇒ The following commands are affected: POA, PSA, VCC.
- ⇒ Before invoking these commands, the axis must be designated as absolute (see 'Homing' and Parameters Ax23 to Ax25).

E R R O R
C a m t o o s h o r t X

Hex Code for Axis 1 = **49**
 Axis 2 = **79**
 Axis 3 = **A9**
 Axis 4 = **D9**

No marker pulse was found for the encoder in the homing cycle.

- ⇒ The home switch cam is too short. The cam must reach one end of the travel distance (see 'Homing').

E R R O R
N o M a r k e r P u l s e X

Hex Code for Axis 1 = **4A**
 Axis 2 = **7A**
 Axis 3 = **AA**
 Axis 4 = **DA**

No marker pulse was detected within one revolution of the encoder during the homing cycle. (see 'Homing').

- ⇒ Check the cable connection, to verify whether the marker pulse signals might be inverted or the marker pulse is not connected.
- ⇒ The encoder does not issue a marker pulse.

E R R O R
M r k r P u l s e P o s A X

Hex Code for Axis 1 = **4B**
 Axis 2 = **7B**
 Axis 3 = **AB**
 Axis 4 = **DB**

In the homing cycle, it has been determined that the distance between the marker pulse for the incremental encoder and the edge of the homing switch cam is less than 1/16 revolution or greater than 15/16 revolution.

ERROR Encoder Fault A1

Hex Code for Axis 1 = **4C**

'Measuring Wheel Operating Mode' is active, but no repositioning by the measuring wheel occurred.

- ⇒ Check if the measuring wheel fails to turn while the drive encoder turns.
- ⇒ If pulses are missing, check the cable connections to the measuring wheel encoder.
- ⇒ Eliminate any slip between material and measuring wheel.
- ⇒ Check the designated direction of the measuring wheel encoder.
- ⇒ Check the parameter settings for the measuring wheel encoder and/or the motor encoder.
- ⇒ Check feed constants.

ERROR Max. Override AX

Hex Code for Axis 1 = **4D**Axis 2 = **7D**Axis 3 = **AD**Axis 4 = **DD**

An override was programmed using the 'VEO' command. The default is set by the measuring wheel encoder for Axis 1. The override velocity in input units (IU) per measuring wheel/per second that has been preset by the measuring wheel encoder is significantly larger than the possible maximum velocity of the axis.

- ⇒ Check programming of the 'VEO' command and, possibly, the 'FOL' command.
- ⇒ Check the measuring wheel parameters C000 to C004.

ERROR AX not enabled

Hex Code for Axis 1 = **4E**Axis 2 = **7E**Axis 3 = **AE**Axis 4 = **DE**

This error occurs if the user program encounters a command for an axis, but the axis has not been enabled in parameter B000 or the axis has been deactivated by the control command "! s M x O F F _ \$ h h Cr Lf" via the serial port.

ERROR Marker high AX

Hex Code for Axis 1 = **4F**
 Axis 2 = **7F**
 Axis 3 = **AF**
 Axis 4 = **DF**

Error message during a homing cycle.

- ⇒ The encoder marker pulse is continuously active, which makes homing impossible.
- ⇒ Check the cable connection, to verify whether the marker pulse signals might be inverted or the marker pulse is not connected.
- ⇒ The encoder does not issue a marker pulse.

ERROR Target Pos < Lim X
--

Hex Code for Axis 1 = **50**
 Axis 2 = **80**
 Axis 3 = **B0**
 Axis 4 = **E0**

In the program, a positioning command was invoked for which the absolute position value is less than the minimum travel limit value.

- ⇒ The following commands are affected: POA and PSA
- ⇒ Check the program and the travel limits (Parameters Ax03 and Ax04).

ERROR Target Pos > Lim X
--

Hex Code for Axis 1 = **51**
 Axis 2 = **81**
 Axis 3 = **B1**
 Axis 4 = **E1**

In the program, a positioning command was invoked for which the absolute position value is greater than the maximum travel limit value.

- ⇒ The following commands are affected: POA and PSA
- ⇒ Check the program and the travel limits (Parameters Ax03 and Ax04).

ERROR HOM - Command AX

Hex Code for Axis 1 = **52**
 Axis 2 = **82**
 Axis 3 = **B2**
 Axis 4 = **E2**

A homing cycle was invoked using the 'HOM' command. Homing is not possible.

- ⇒ Check Parameters Ax23 to Ax25.
- ⇒ Homing using position detection via the absolute encoder is not possible.

Notes

12 Terminal Connection Diagrams

12.1 Overview

Name	Page
Fig. 12-1: CLM1.4 Dimensions	12-2
Fig. 12-2: Connector X5 – Power Supply and System Signals, A1 & 2	12-3
Fig. 12-3: Connector X19 – System Signals, A3 & 4	12-3
Fig. 12-4: Connector X7 – System Signals A1 to 4	12-4
Fig. 12-5: Connector X6 – Data Interfaces, General Overview	12-4
Fig. 12-6: Connector X6 – RS232C/RS485 Data Interface – Serial Channel A	12-5
Fig. 12-7: Connector X6 – RS485 Data Interface – Channel A	12-6
Fig. 12-8: Connector X8 – RS232C/RS485 Data Interface – Serial Channel B	12-7
Fig. 12-9: Connector X1 – Axis 1 Encoder Inputs	12-8
Fig. 12-10 Connector X2 – Axis 2 Encoder Inputs	12-9
Fig. 12-11 Connector X20 – Axis 3 Encoder Inputs	12-10
Fig. 12-12 Connector X21 – Axis 4 Encoder Inputs	12-11
Fig. 12-13 Connector X3 – Inputs – Part 1	12-12
Fig. 12-14 Connector X11 – Inputs – Part 2	12-13
Fig. 12-15 Connector X12 – Inputs – Part 3	12-14
Fig. 12-16 Connector X4 – Outputs – Part 1	12-15
Fig. 12-17 Connector X13 – Outputs – Part 2	12-16
Fig. 12-18 Connector X22 – Inputs and Outputs	12-17
Fig. 12-19 CLM1.4 Typecodes	12-18

12.2 CLM1.4 Dimensions

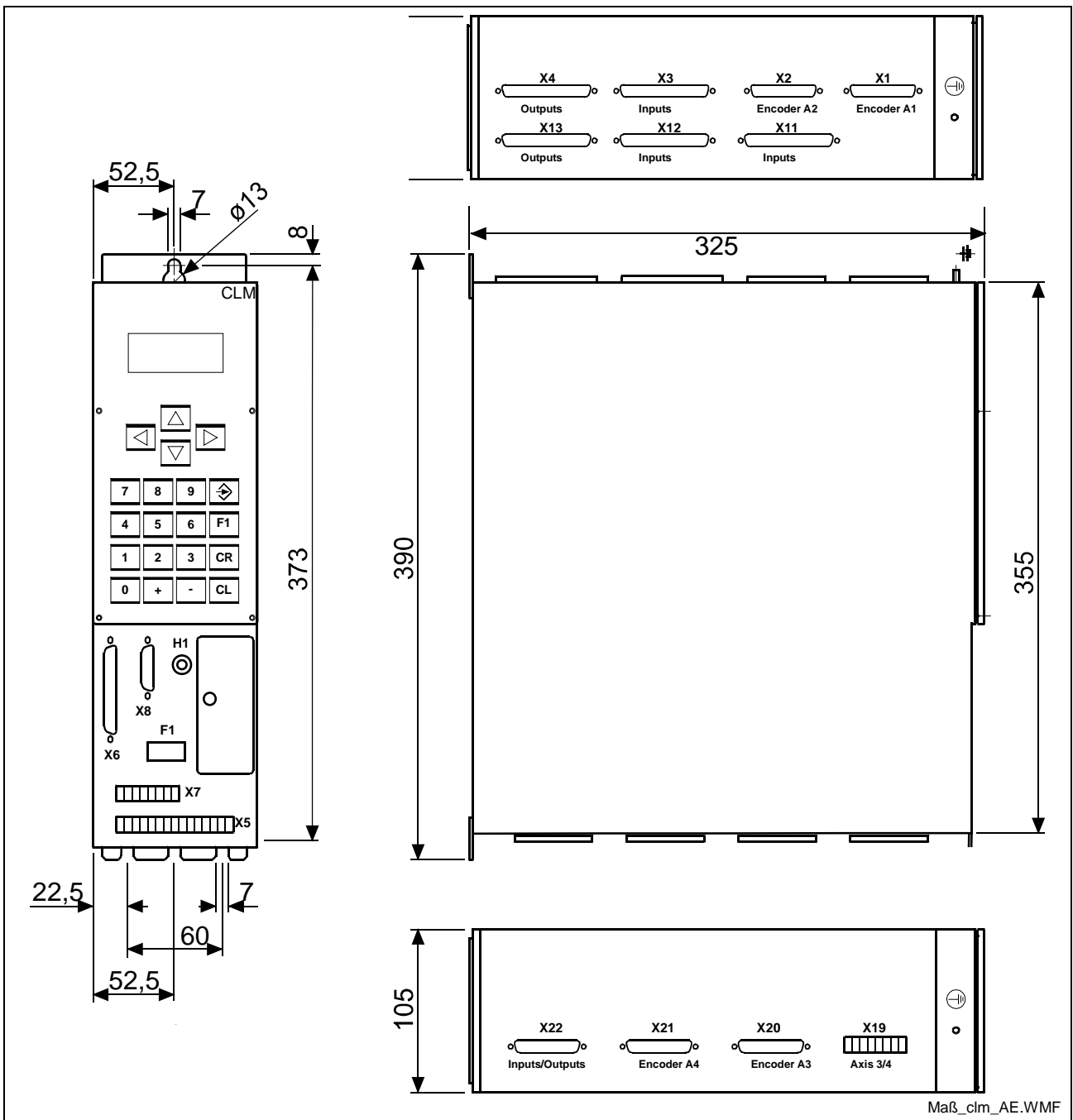

Fig. 12-1: CLM1.4 Dimensions

12.3 Power Supply and System Signals for Axes 1 and 2

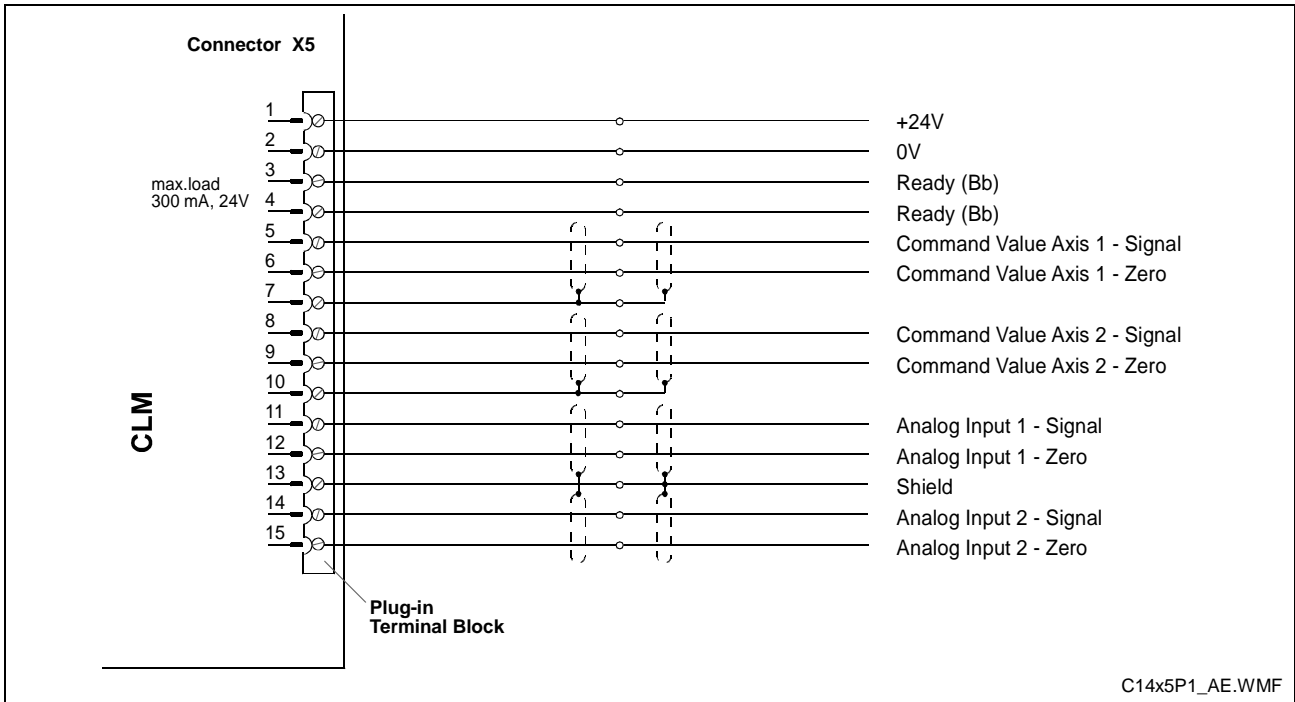

Fig. 12-2: Connector X5 – Power Supply and System Signals, A1 & 2

12.4 System Signals for Axes 3 and 4

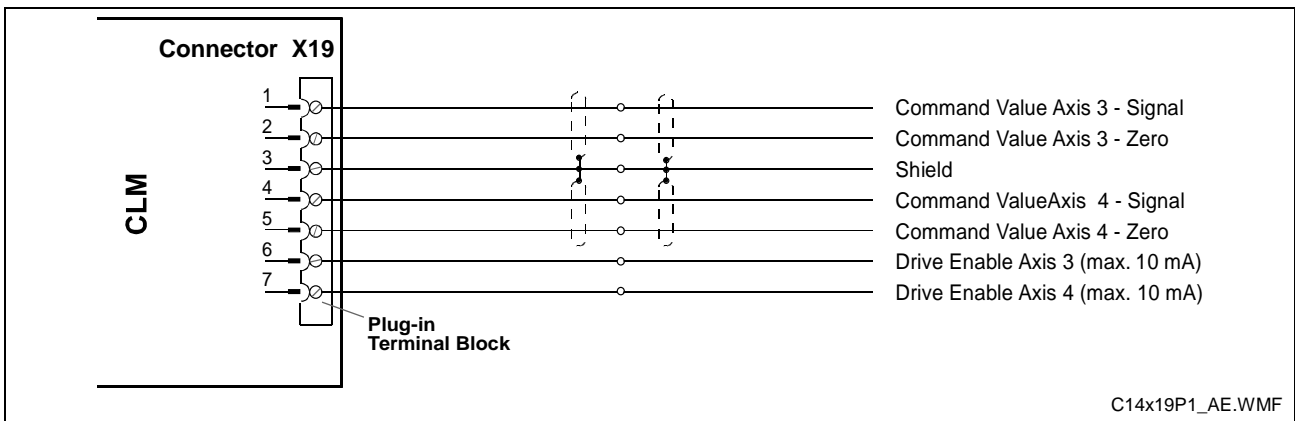

Fig. 12-3: Connector X19 – System Signals, A3 & 4

12.5 System Signals for Axes 1 to 4

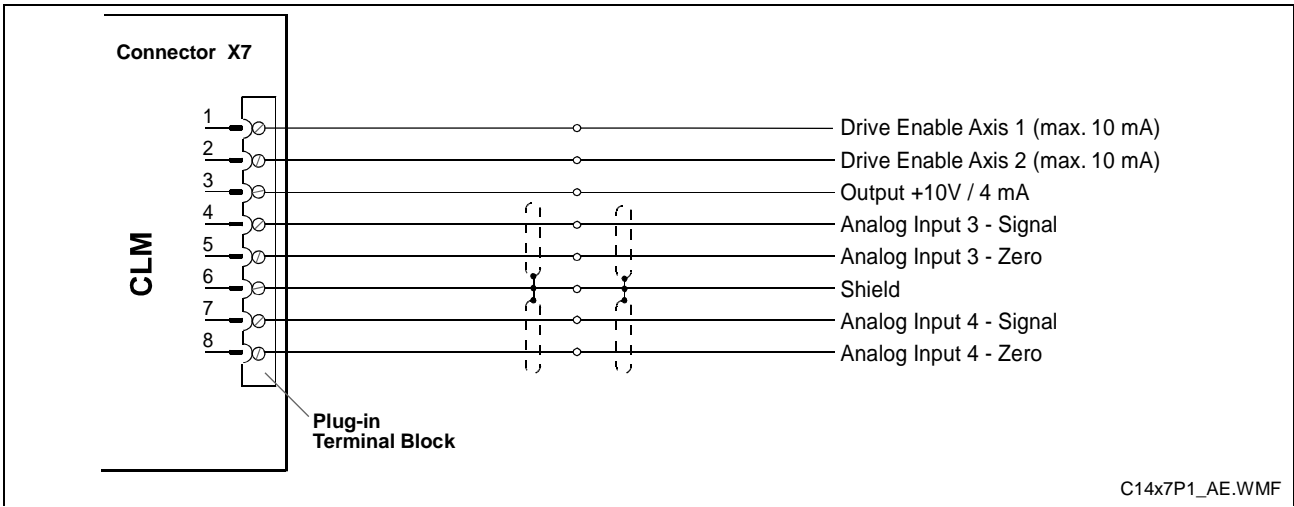

Fig. 12-4: Connector X7 – System Signals A1 to 4

12.6 Data Interface – Serial Channel A

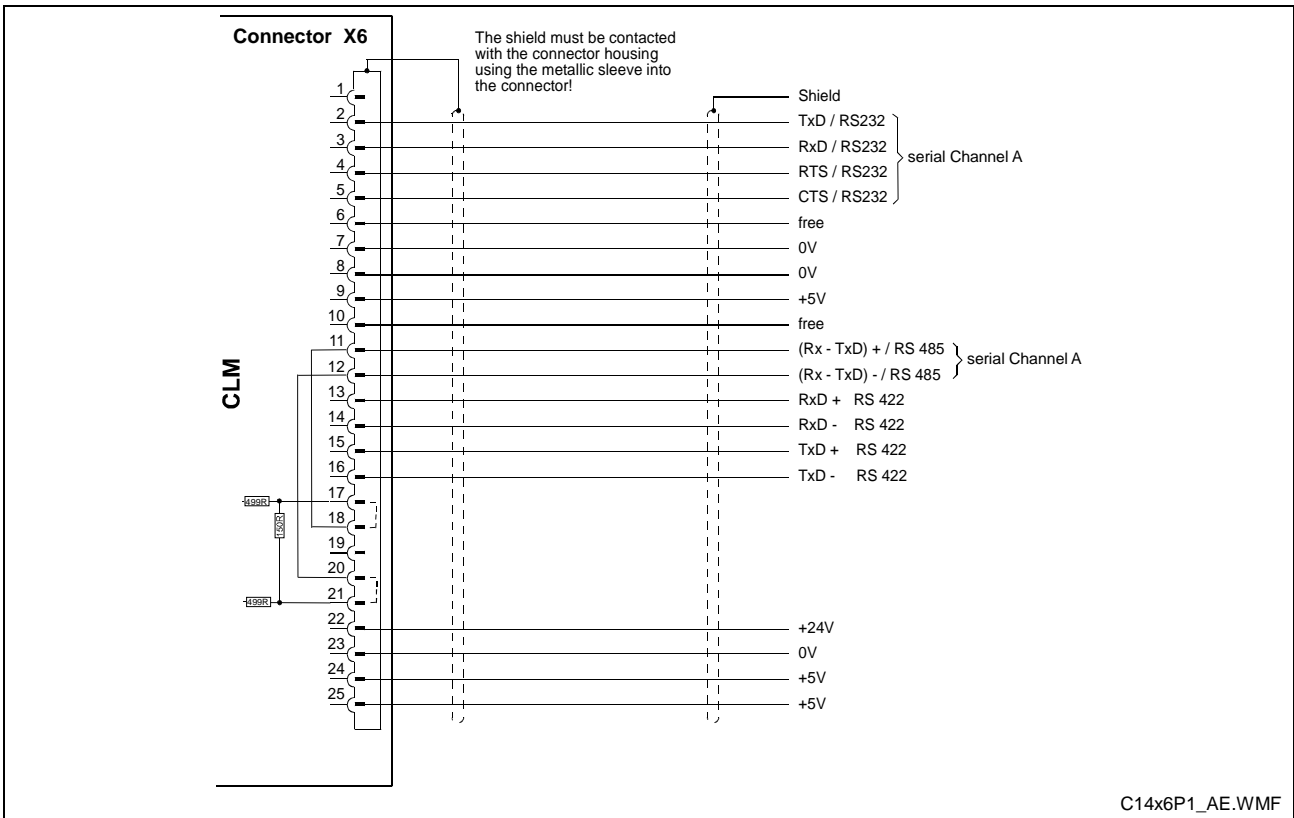

Fig. 12-5: Connector X6 – Data Interfaces, General Overview

12.7 RS232C/RS485 Data Interface – Serial Channel A

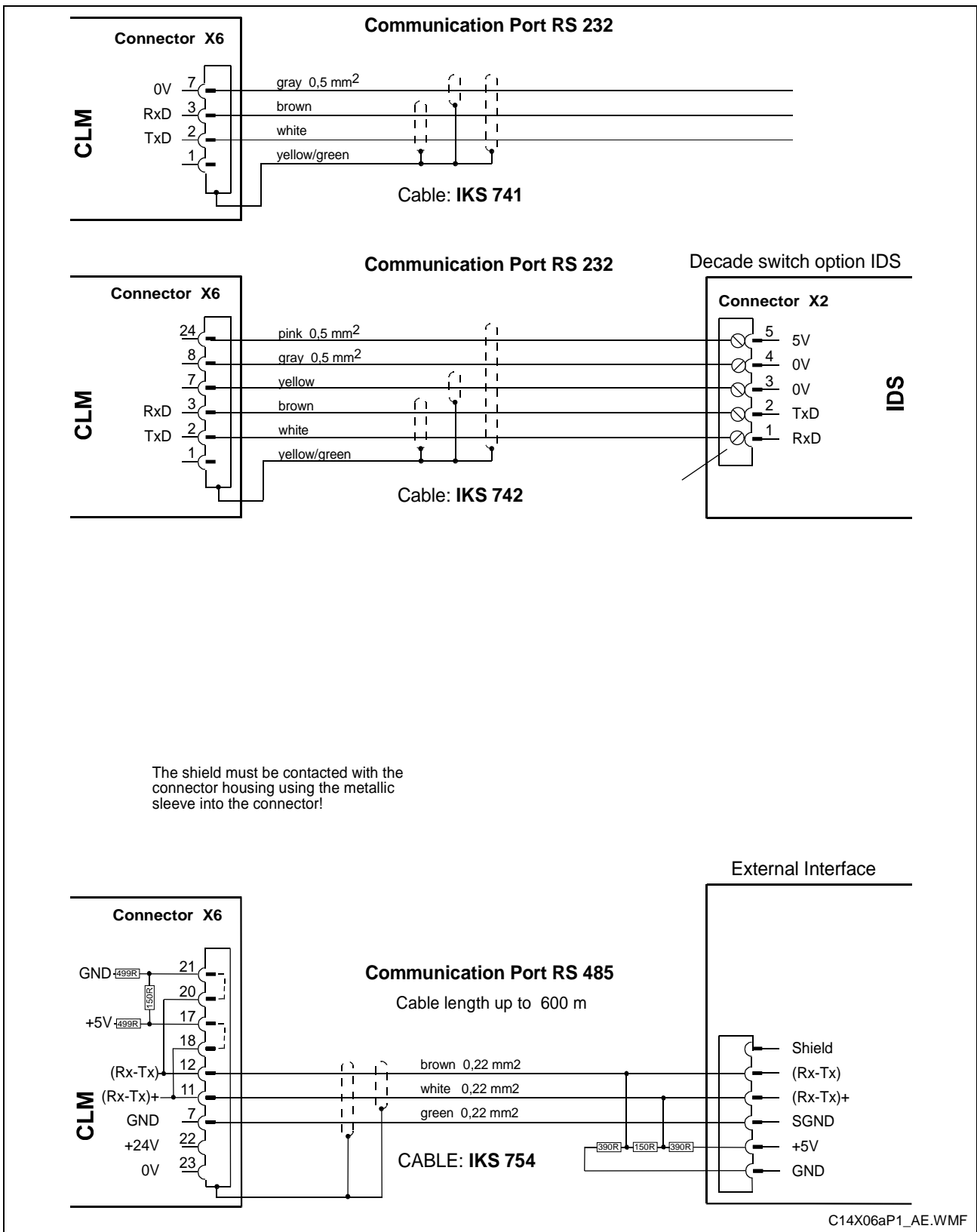

Fig. 12-6: Connector X6 – RS232C/RS485 Data Interface – Serial Channel A

12.8 RS485 Data Interface – Serial Channel A

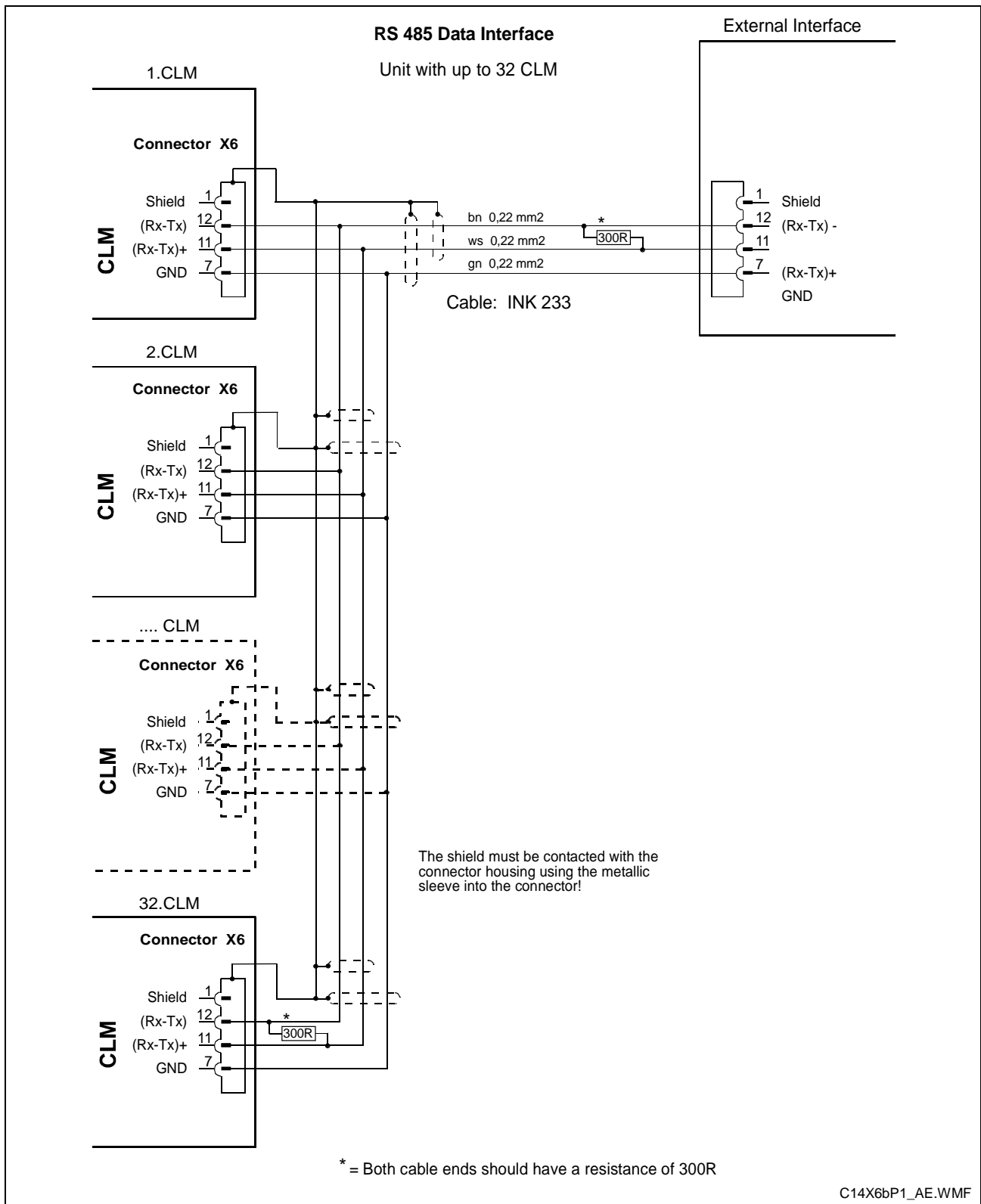

Fig. 12-7: Connector X6 – RS485 Data Interface – Channel A

12.9 RS232C/RS485 Data Interface – Serial Channel B

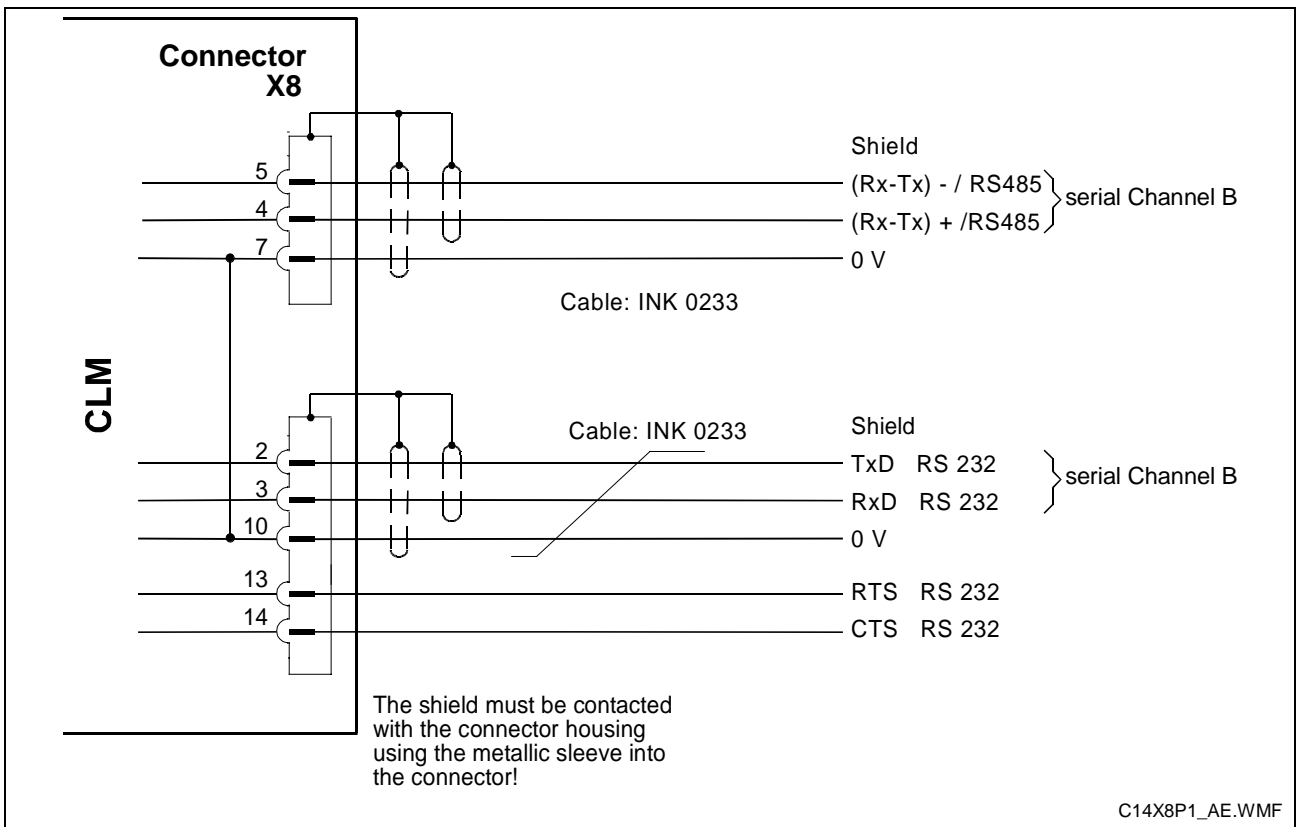

Fig. 12-8: Connector X8 – RS232C/RS485 Data Interface – Serial Channel B

12.10 Axis 1 Encoder Inputs

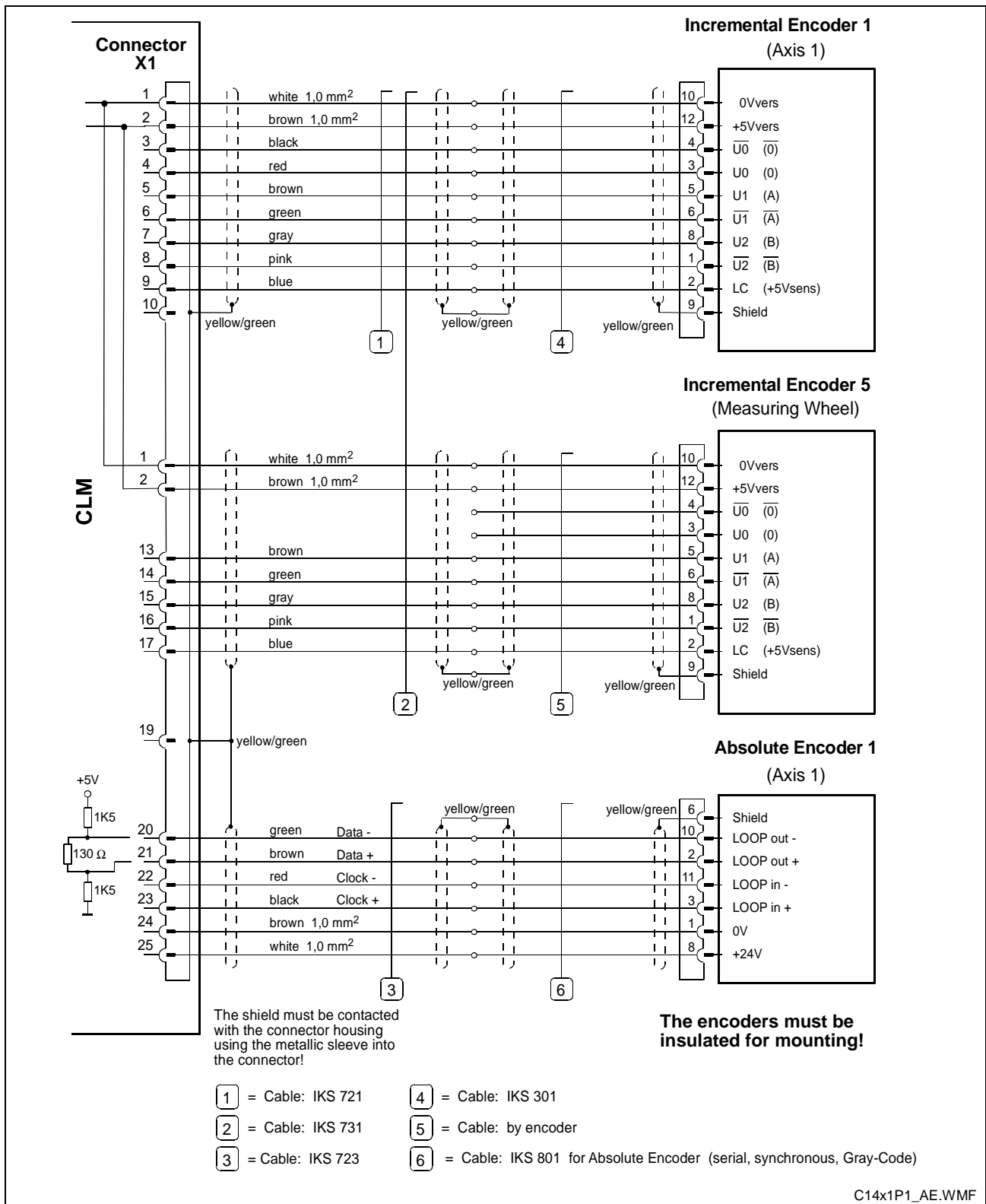

Fig. 12-9: Connector X1 – Axis 1 Encoder Inputs

12.11 Axis 2 Encoder Inputs

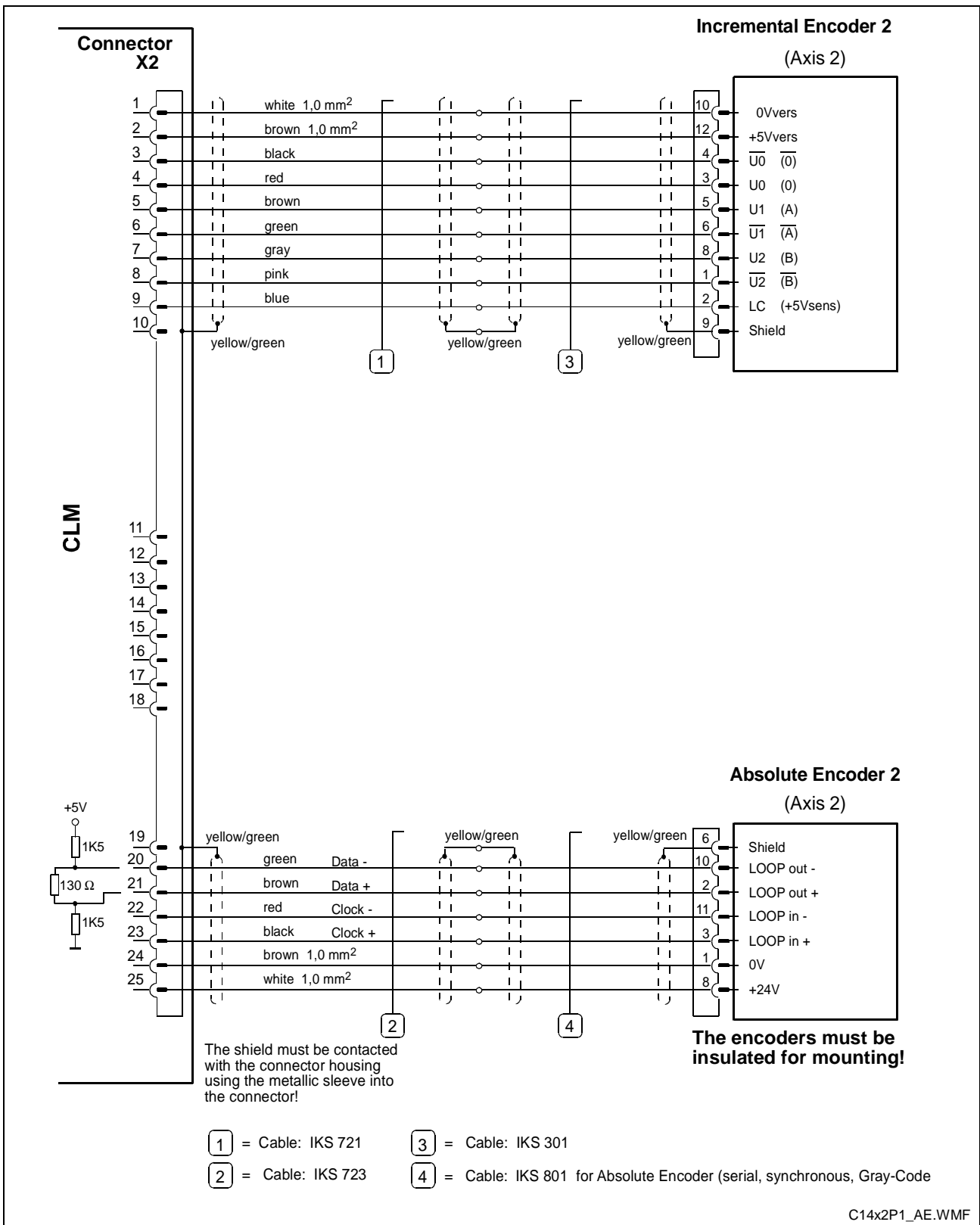

Fig. 12-10 Connector X2 – Axis 2 Encoder Inputs

12.12 Axis 3 Encoder Inputs

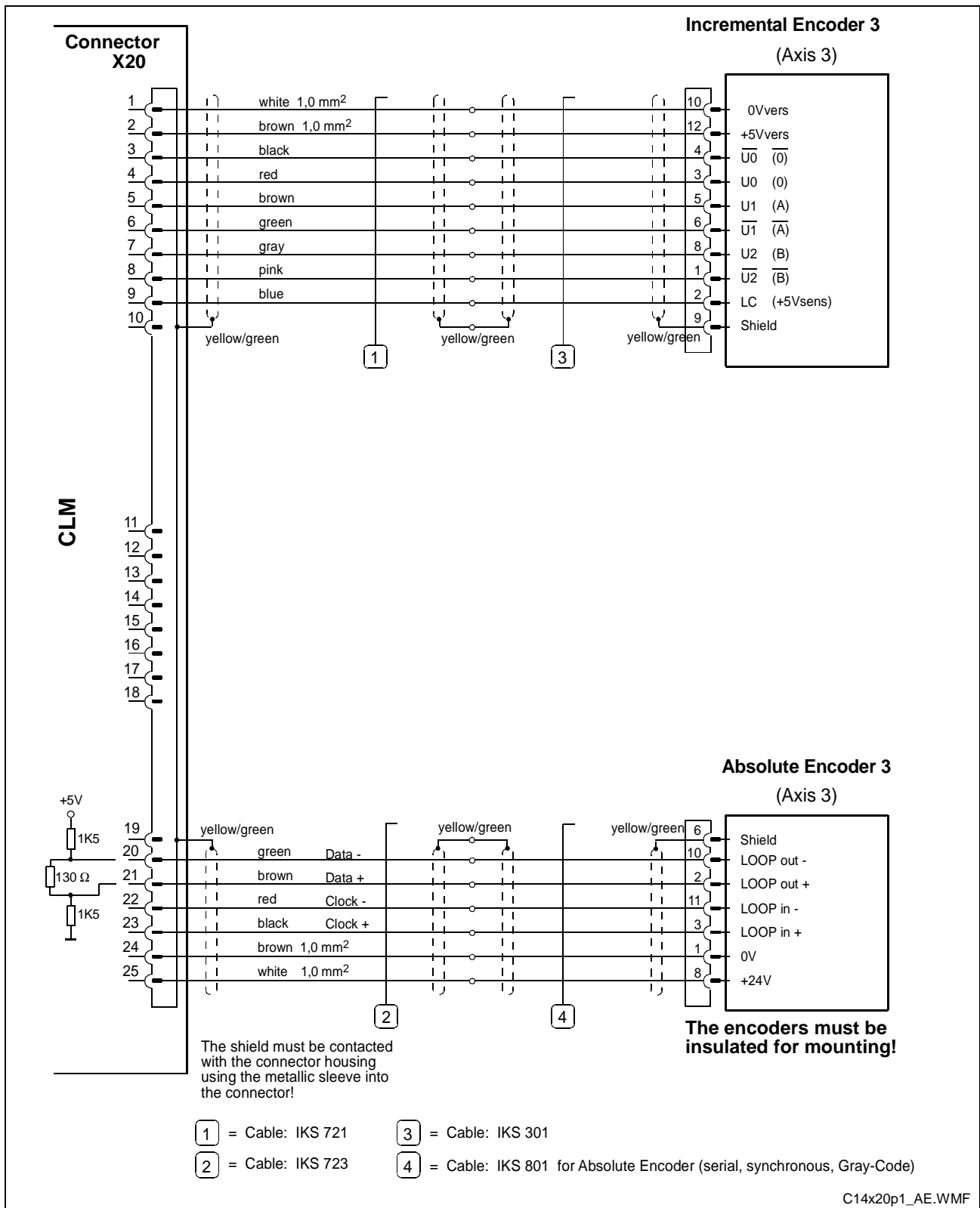

Fig. 12-11 Connector X20 – Axis 3 Encoder Inputs

12.13 Axis 4 Encoder Inputs

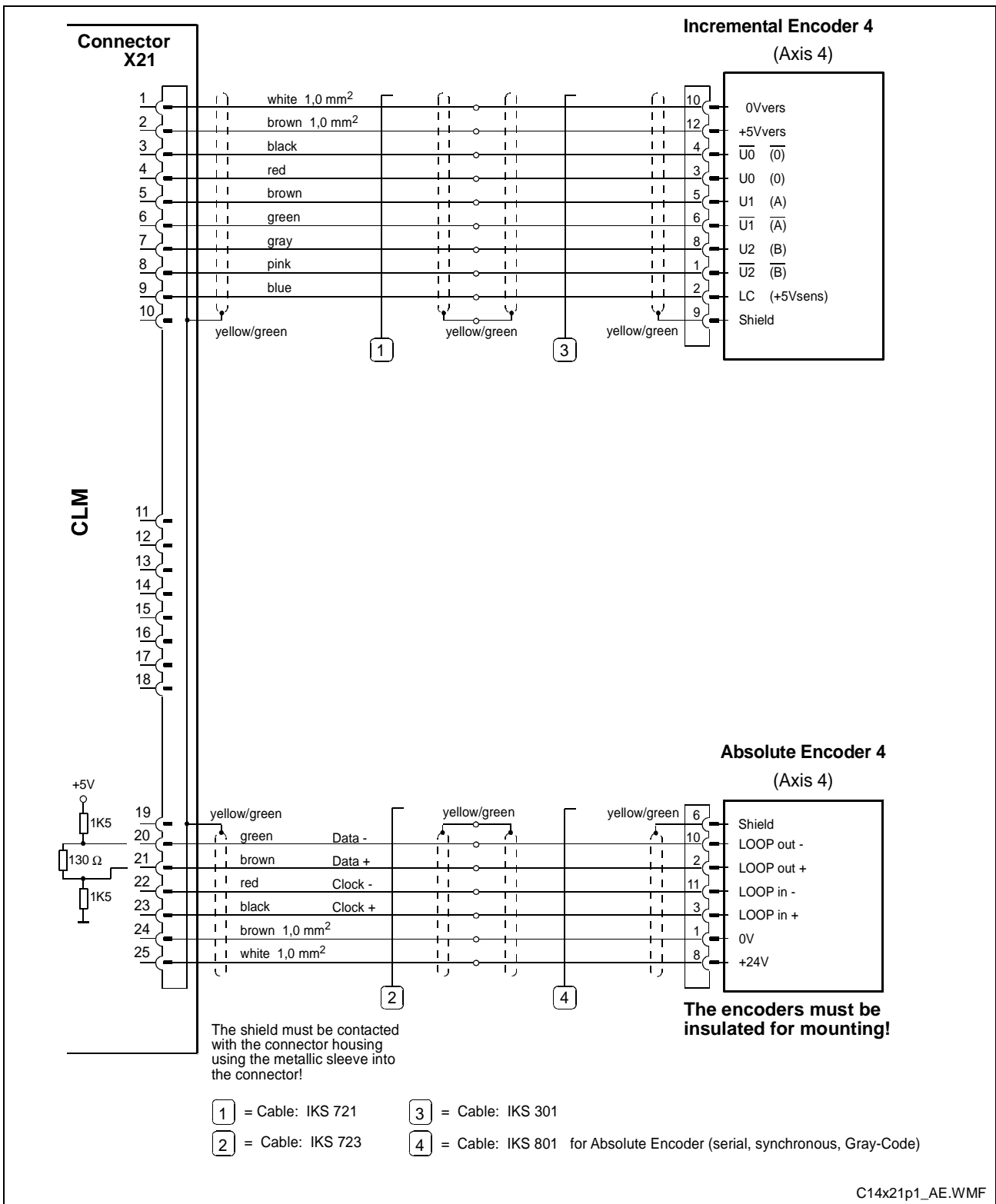

Fig. 12-12 Connector X21 – Axis 4 Encoder Inputs

12.14 Inputs – Part 1

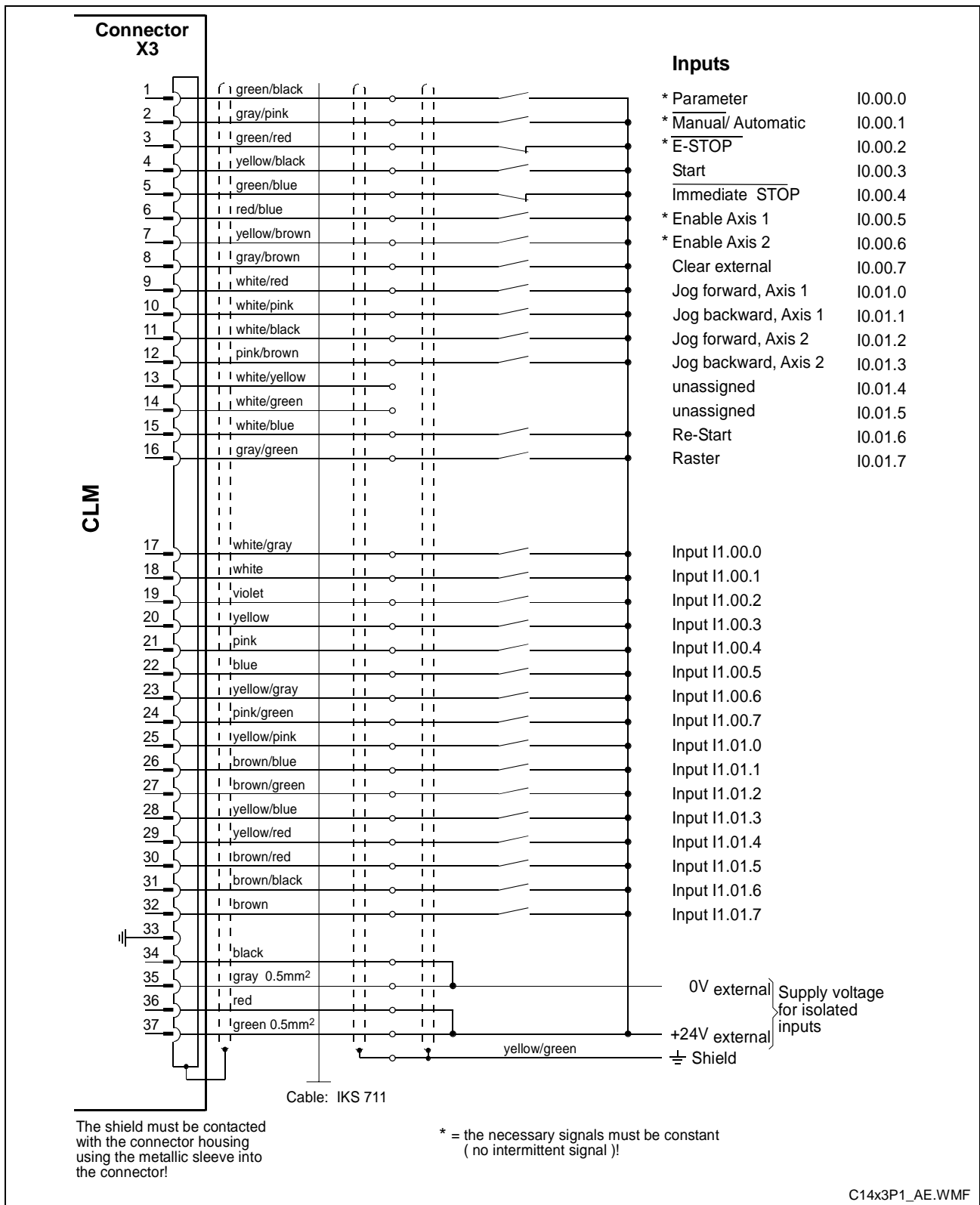

Fig. 12-13 Connector X3 – Inputs – Part 1

12.15 Inputs – Part 2

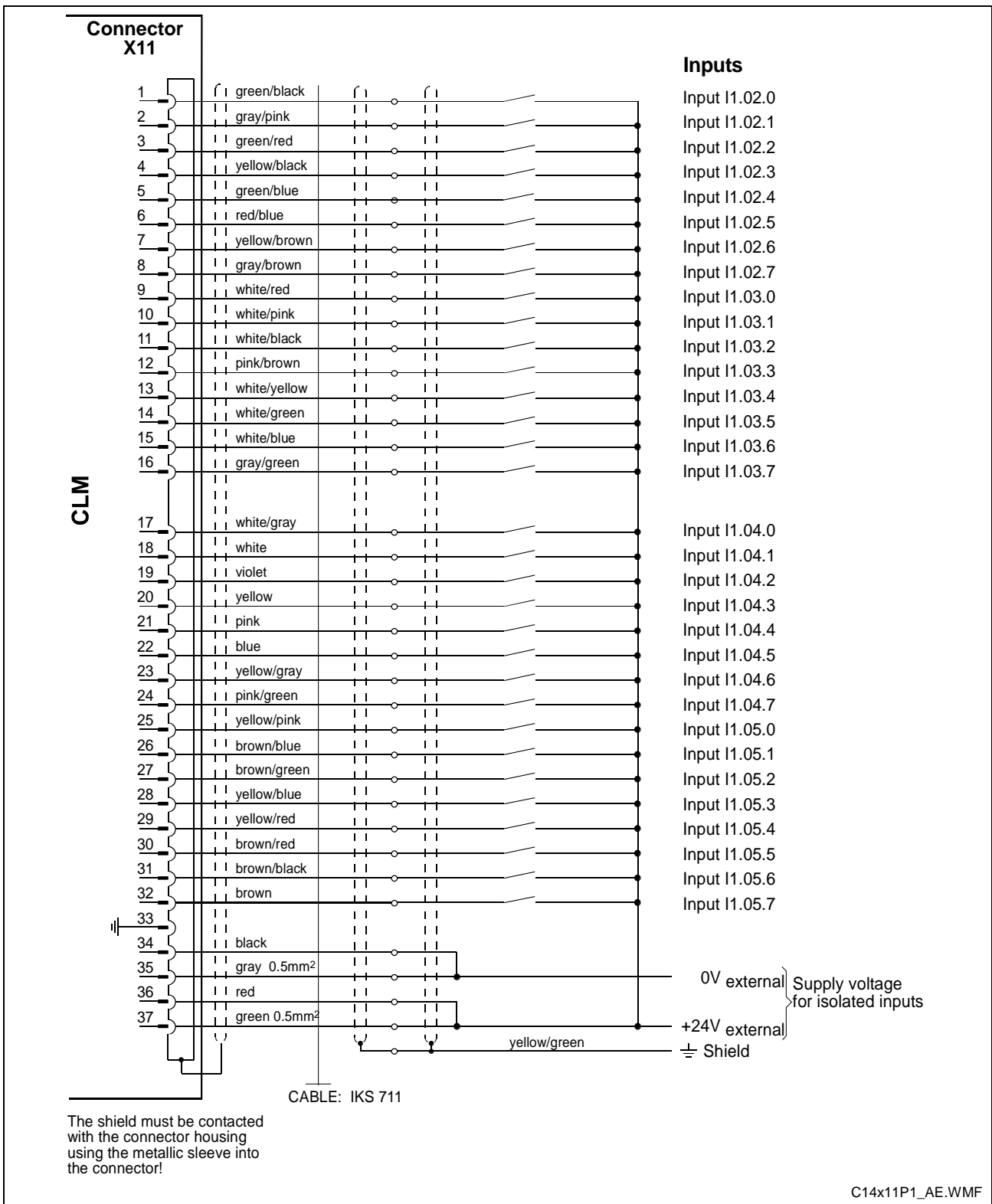

Fig. 12-14 Connector X11 – Inputs – Part 2

12.16 Inputs – Part 3

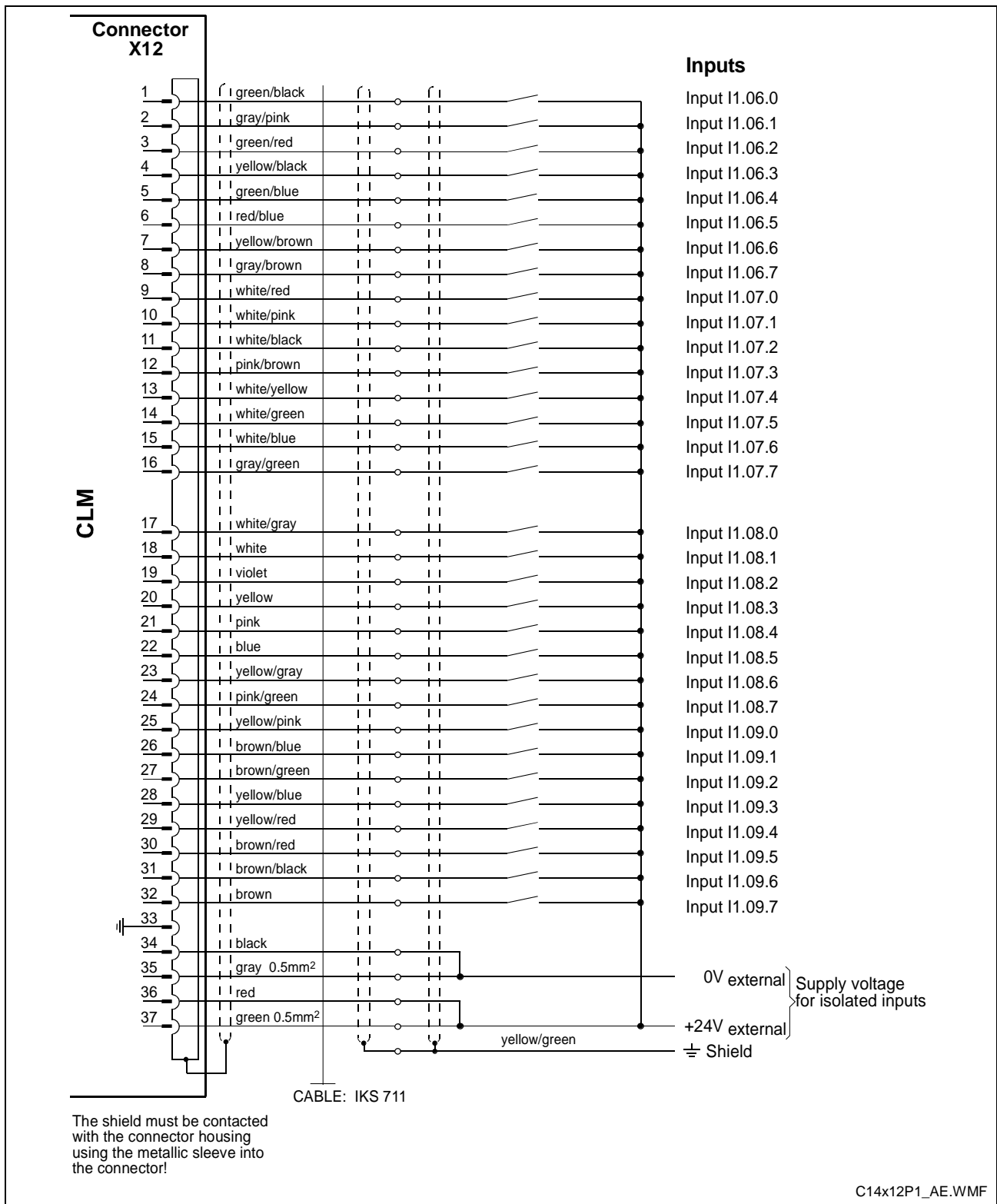

Fig. 12-15 Connector X12 – Inputs – Part 3

12.17 Outputs – Part 1

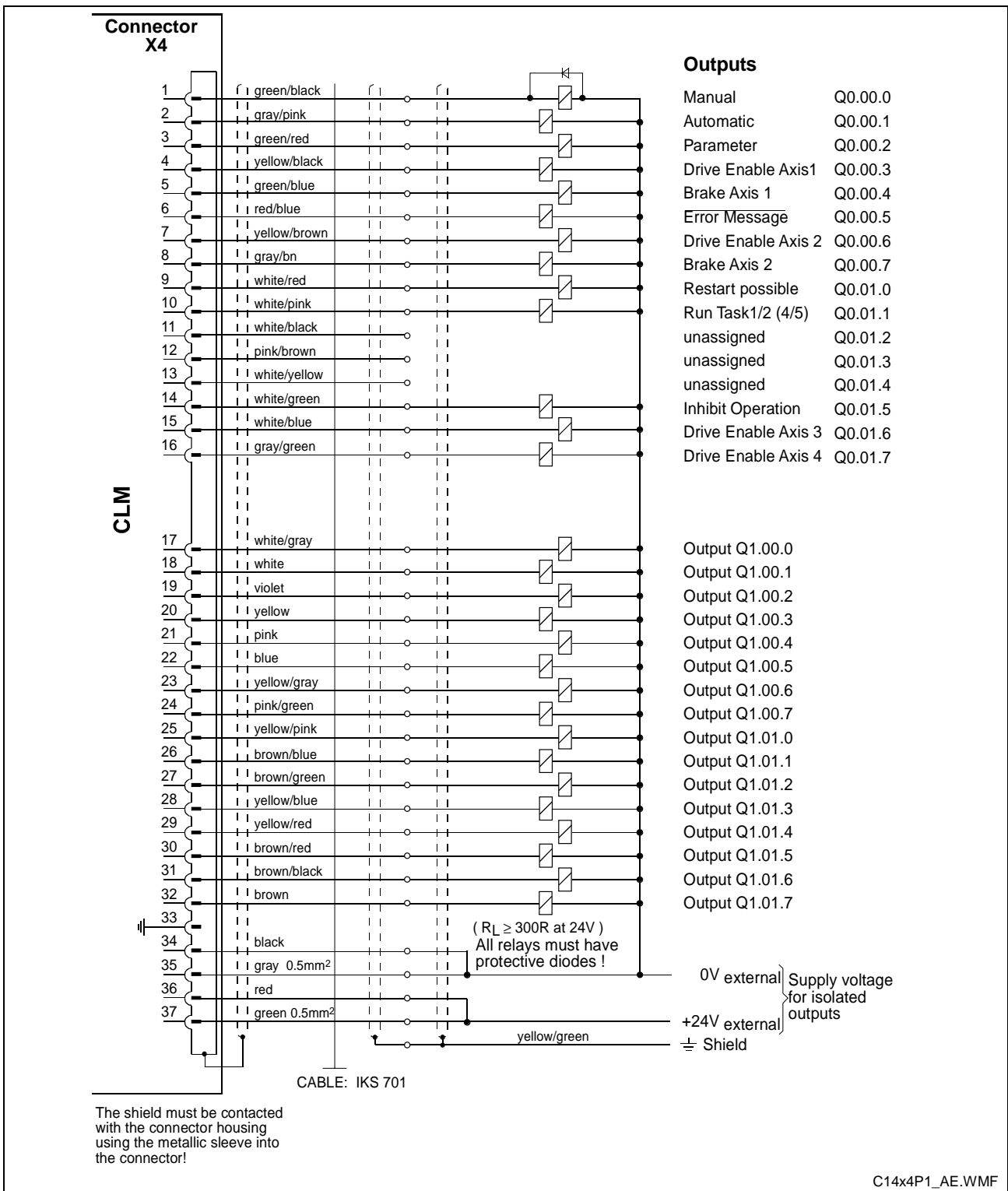

Fig. 12-16 Connector X4 – Outputs – Part 1

12.18 Outputs – Part 2

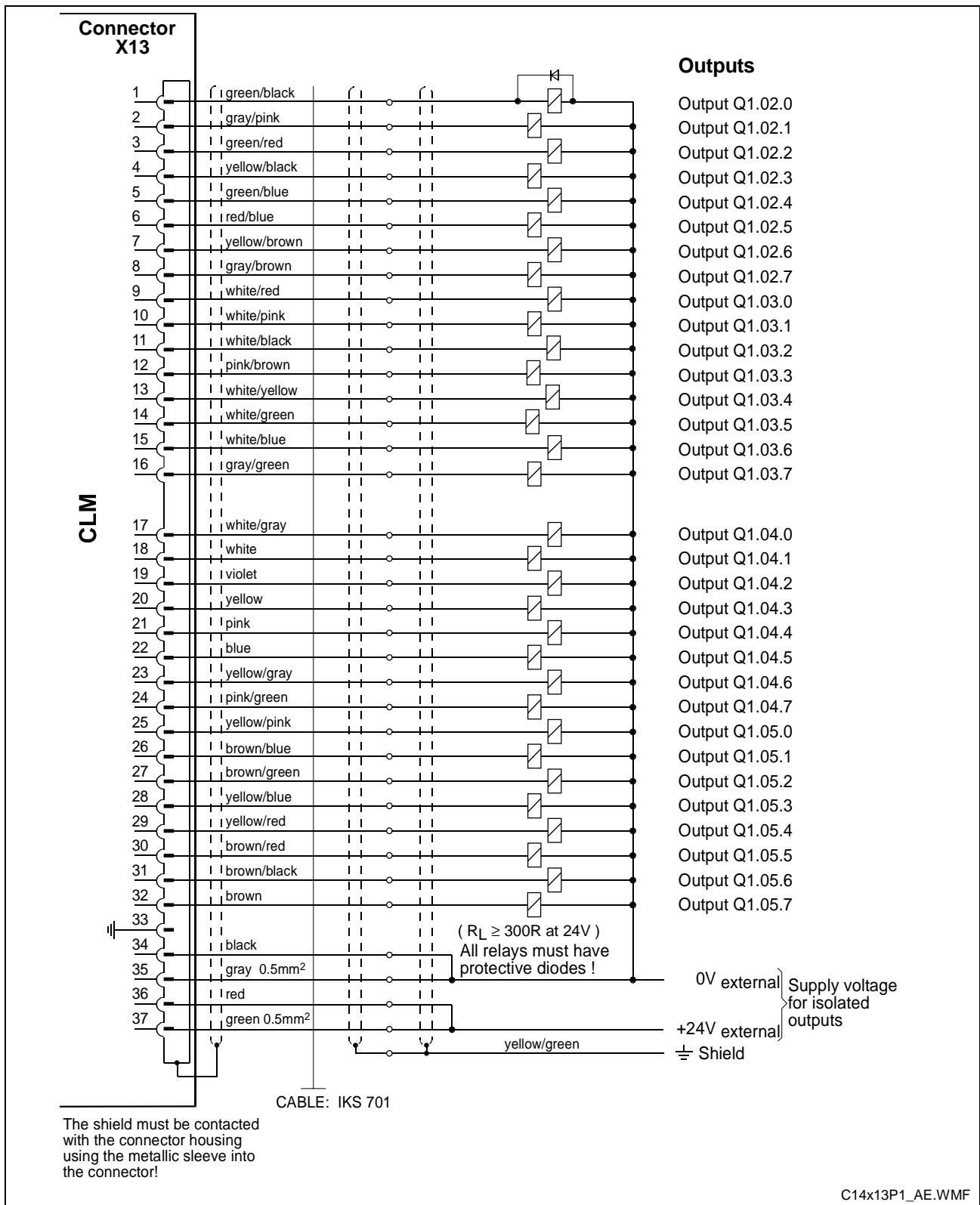

Fig. 12-17 Connector X13 – Outputs – Part 2

12.19 Inputs and Outputs

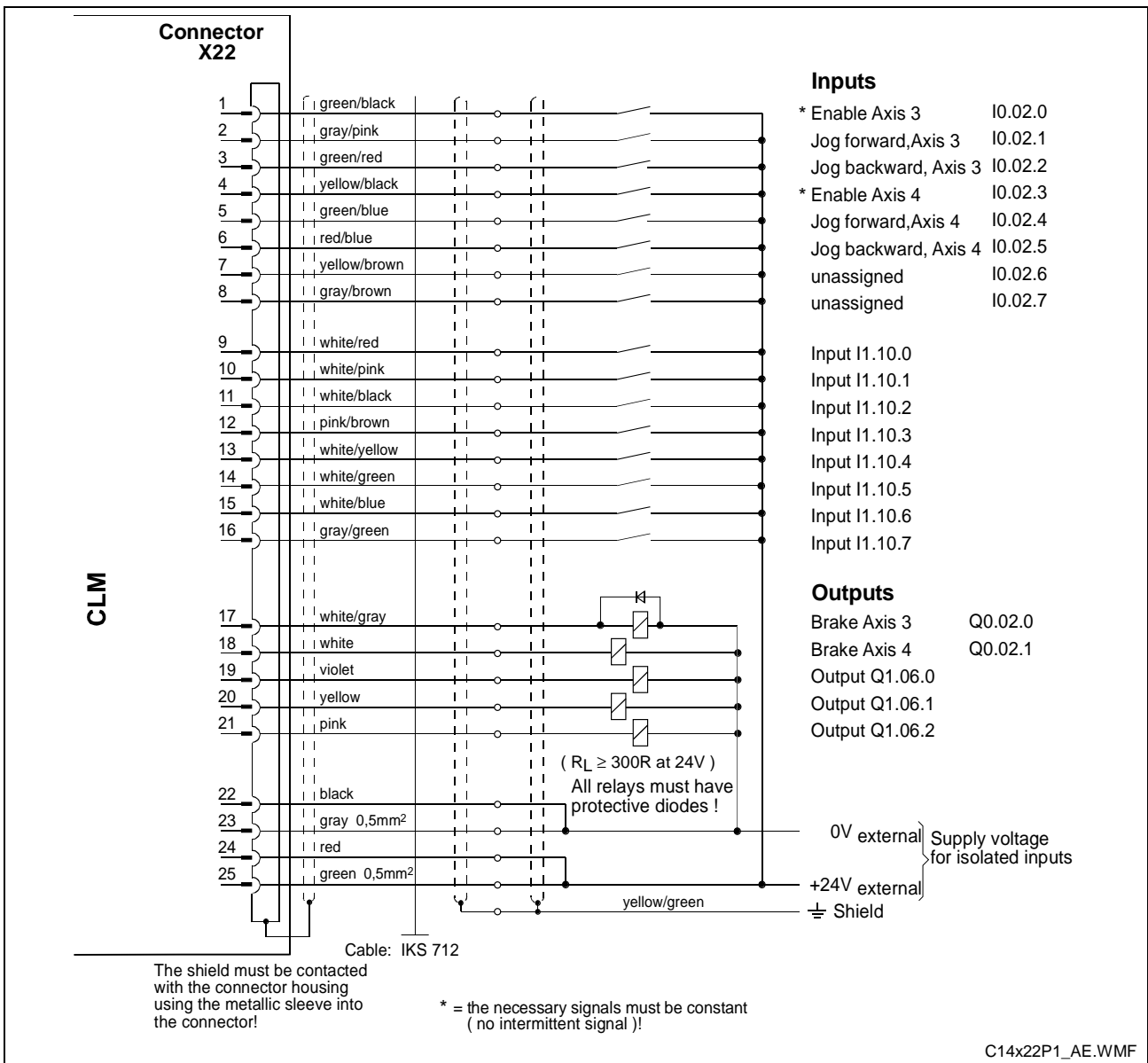

Fig. 12-18 Connector X22 – Inputs and Outputs

12.20 Typecodes

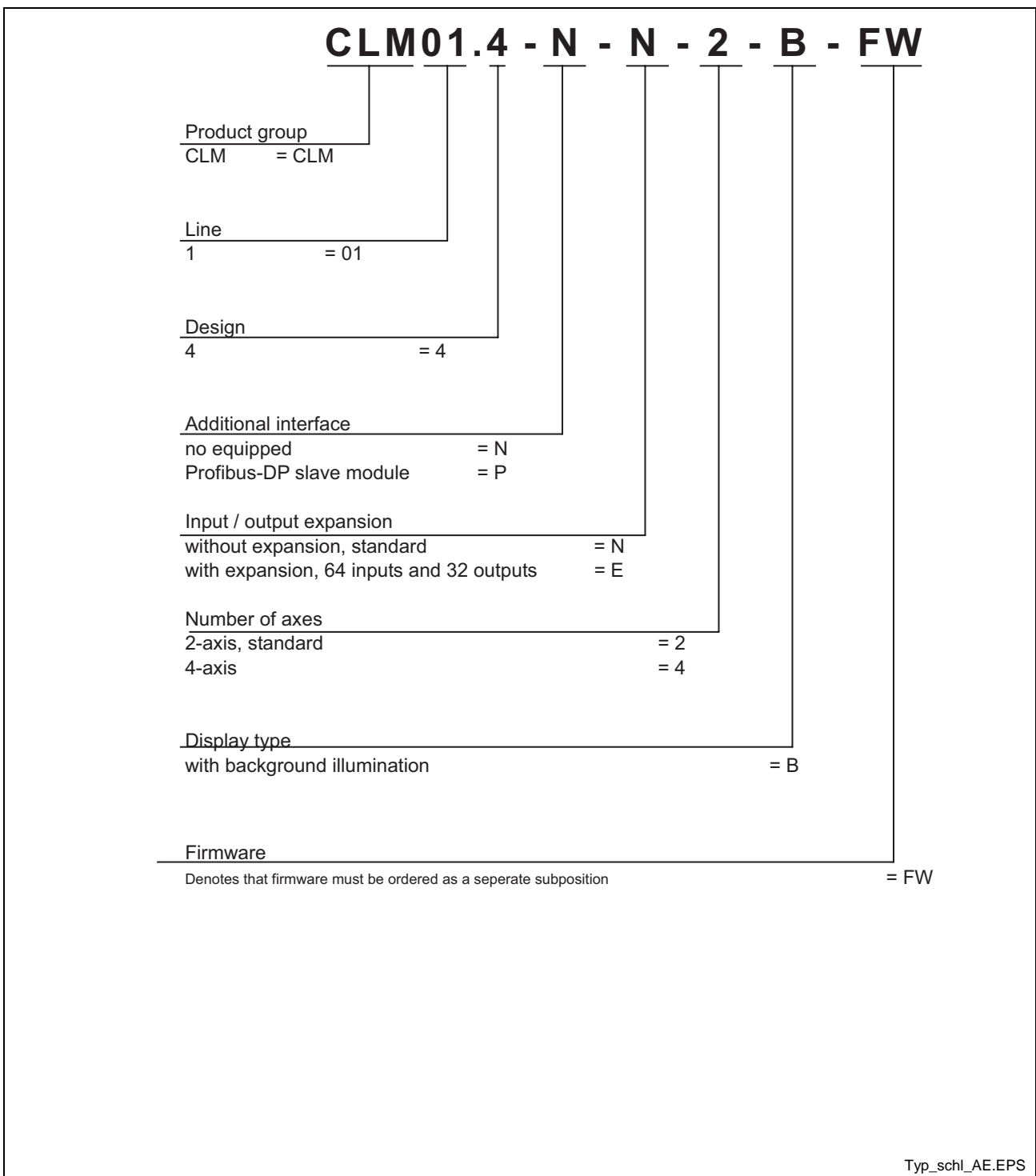

Fig. 12-19 CLM1.4 Typecodes

13 Installation Notes

13.1 General Information

These controls are designed as modular units to be built into a control cabinet. The controls are electrically connected via connectors on the top side of the unit.

Protection System:

Front Panel = IP 20

Electronics and Connectors = IP 20

The installation should offer a type of protection appropriate for the environmental conditions, for protection of the unit especially against deposits of metal dust, oil, moisture and strong electromagnetic interference, as well as for maintaining the allowable ambient temperature.

Max. allowable ambient temperature:

with natural air flow = 45° Celsius

with forced ventilation
at 3 m/s air speed = 55° Celsius

Min. allowable ambient temperature: = 5° Celsius

Local power loss = 45 W max.

Reliability These controls are exemplary in their resistance to network and switching problems. However, the following rules must be followed during installation, to eliminate excessive problem situations.

Interference Suppression With electronic controls, no inductive loads should be moved without appropriate interference suppression.

For operation with DC voltage, appropriate interference suppression is achieved by the arrangement of free-wheeling diodes, and for operation with AC voltage, it is achieved by the arrangement of type-specific, standard RC interference suppression elements directly at the inductance.

Only the interference suppression element that is arranged directly at the inductance fulfills the intended purpose!

If this is not the case [installation directly at the inductance], more interference actually results because of surges in the interference suppression circuitry.

This general rule should be followed as closely as possible. It is far easier to prevent interference than to eliminate the results of existing interference.

Under no circumstances can contacts that control the movement of inductive loads, inductances without interference protection, or connections between such elements, be used in the same area as the control.

This means that the control must be separated from such sources of interference by a Faraday's cage (its own section in the control cabinet).

Wiring of the Controller Cables

The controller cables must meet the minimum requirements for diameter, shielding and grounding listed in the Terminal Connection Diagrams. The illustrated branching conditions must also be met. It does not suffice to establish the galvanic connections; the connection points must be adhered to.

If, for example, two parallel leads that branch from one point are shown, it is unacceptable to connect only one lead and to branch it at a later point.

Induction looping (error transmitters and antennas) and potential shifting that causes interference can occur.

Switching Signal Inputs and Outputs

The switching signal inputs and outputs are galvanically isolated using an opto-electronic coupler and can be wired without much concern. However, these cables are subject to interference and must therefore be kept well away from all other controller cables for every part of the installation.

This means that these cables must be wired to the controller from a different direction or, when wired in parallel, they must be run through separate steel tubing.

Of course, the same is true for the cables for the respective power supply.

Controller and Power Supply Cables

The cables between the controller and the drive electronics should be as short as possible.

With the exception of the switching signal inputs and outputs described above, the controller cables are subject to the following rules.

No unshielded wiring in areas without interference protection (cabinet and canal). See also Section 13.1, 'Interference Suppression.'

No parallel wiring of controller, network and power cables without special protection measures for the controller cables.

No parallel wiring of controller cables with other system cables without special protection measures for the controller cables.

This means: Controller cables and controller power cables, when wired parallel to other system components, must be run through steel or other metal tubing. This is also valid, even if these cables are already shielded and also in relation to the power cables for the electric servo drives.

- Power Cables** The power cables for the electric servo drives, meaning the primary and secondary cables for the power transformer and the motor connections, are relatively resistant to interference.
- Because of the emissions from these cables, all controller cables, e.g. tachometer, command value and incremental encoder cables, must be separated.
- The wiring of the power cables for the servo drives within the part of the control cabinet that houses the control must be as short as possible and as far away from the controller and the controller cables as possible.
- Power Transformer and Smoothing Throttle** The power transformer and the smoothing throttle of electrical servo drives may not be arranged in the same area (of the control cabinet) as the controller, because of the generated heat and emissions.
- Connection to Power Supply** For electric servo drives, the power connection for the drive electronics is to be branched from the power supply connection, separately from the controller cabling.
- When these cables are run parallel to other system cables, the power supply cabling must be run inside grounded steel or metal tubing.
- Grounding** Correct grounding is one of the critical prerequisites for fault-free operation. For grounding, the branching conditions in the terminal connection diagrams must be strictly followed.
- If branching from the defined central point does not follow the illustration, fault (induction) loops will result.
- Grounding bars of any strength have no effect with improper branching.
- Control Power Transformer** A transformer with protection winding is to be used as the control power transformer. The protection winding must be run to the central grounding point.

13.2 Instructions for Using Cooling Units in Control Cabinets

To maintain ambient conditions in control cabinets, it may be necessary to cool the air inside the control cabinet with a cooling unit.

Improperly used cooling units can cause damage to the installed controllers because of condensation and condensate!

Damage by Condensation Warm, damp air enters the control cabinet and condensation collects on the control units during cooling!

Damage by Condensate If cooling units are poorly arranged, the condensate that is continually produced by the cooling units can drip into control units or be sprayed inside them by the cool air stream.

Correct Use of Cooling Units

Avoiding Condensation Use cooling units only with well-insulated control cabinets, to avoid condensation due to warm, damp outside air!

If the control cabinets are being used with open doors (initial startup, service, etc.), ensure that the control units can never be cooler than the air in the control cabinet after the doors are closed, otherwise condensation can occur. The cooling unit must continue to be operated even when the system is turned off, until the temperature of the air in the control cabinet and the installed equipment remains at the same level.

Set cooling units with a fixed temperature setting to not lower than 40° C!

Set cooling units with adjustable temperature setting so that the inside air temperature of the control cabinet is not below that of the outside temperature. Set temperature limit to 40° C!

Avoiding Drips and Sprays Arrange cooling units so that any condensate cannot drip into or on the installed control units.

Cooling units on the top of the control cabinet require a specialized control cabinet construction (see Fig. 13-1).

The control cabinet should be constructed so that the fan for the cooling unit cannot spray the condensate that collects after the unit has been turned off for a period of time on the control units (see Fig. 13-2).

Note: No water must be allowed to drip on the installed control units! Furthermore, the correct temperature of the cooling units must be observed!

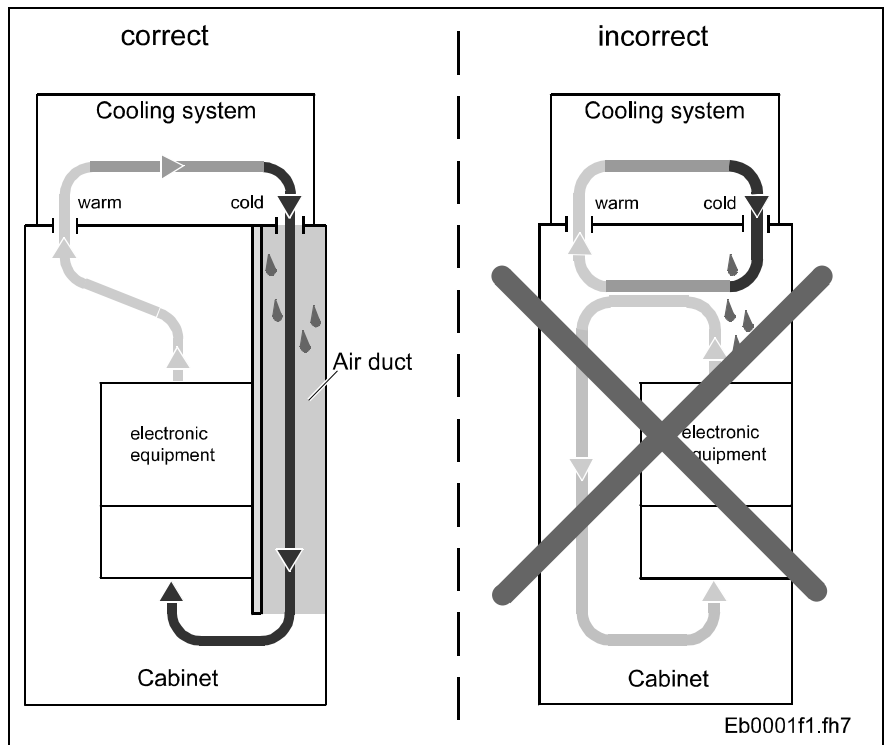

Fig. 13-1: Arrangement of the Cooling Unit on the Top of the Control Cabinet

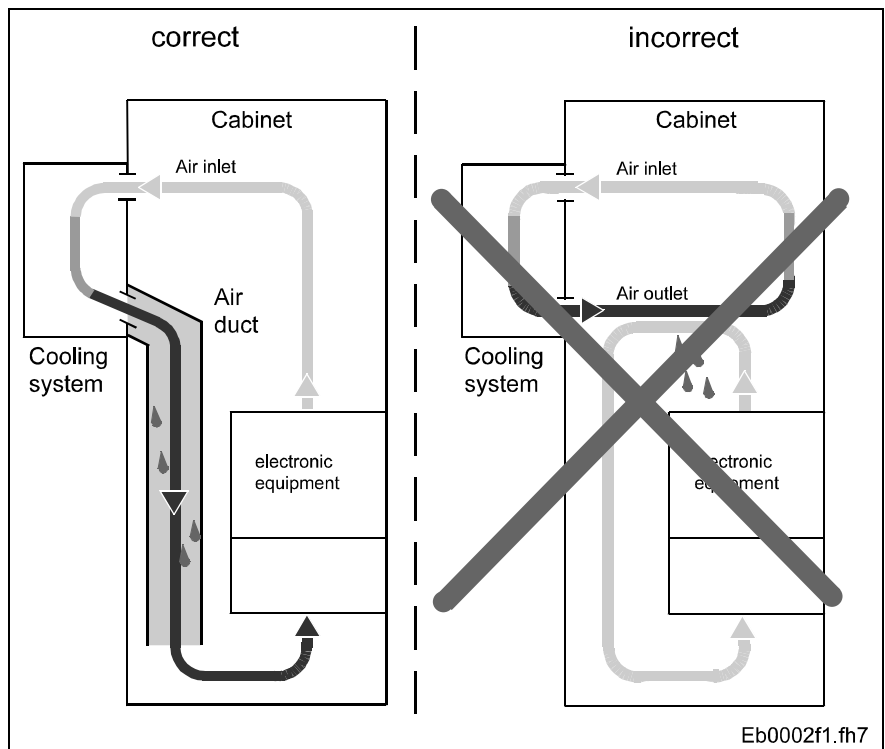

Fig. 13-2: Arrangement of the Cooling Unit on the Front of the Control Cabinet

13.3 Safety Instructions for Controls

General Information

Follow these personnel safety instructions before using the control:

- Always follow the safety instructions that appear in the operating instructions. Inappropriate use of this equipment, failure to follow the safety instructions in this document may result in product damage, personal injury, or even death.
- INDRAMAT GmbH is not liable for damage resulting from failure to observe the warnings given in this documentation.
- Before start-up, the documentation in the local language is to be requested, if the documentation in the language provided is not completely understood.
- Proper transport, correct storage, assembly and installation, as well as due care in operation and maintenance, are prerequisites for optimal and safe operation of this equipment.
- Only qualified personnel may work on this equipment or within its proximity. Personnel are qualified if they have sufficient knowledge of the assembly, installation and operation of the product, as well as an understanding of all warnings and precautionary measures noted in these instructions. Furthermore, they should be trained, instructed or qualified to switch electrical circuits and equipment on and off, to ground them and to label them. They must have adequate safety equipment and be trained in first aid.
- Use only replacement parts approved by the manufacturer.
- Follow all safety regulations and requirements for the specific application.
- The equipment is designed for installation in commercial machinery.
- Start-up is permitted only after it has been determined that the machine in which the product is installed complies with the requirements of the EC Directive 89/ 392/ EEC (machine guideline).
- Operation is only permitted if the national EMC regulations are met for the application in question. In the EC, the EMC Directive 89/ 336/ EEC is valid.
- Technical data, connections and installation conditions are specified in the product documentation and must be followed at all times.

Protection Against Contact with Electrical Parts

Relevant for controls and control components with voltages above 50 V:

Making contact with parts conducting voltages above 50 V can be dangerous to personnel. When operating electrical equipment, it is unavoidable that some parts of the unit conduct dangerous voltages.



DANGER

Live parts (voltages higher than 50 V) on the power supply and power section

Electric shock by touching. Risk of death or serious bodily injury.

⇒ Construction and design according to the following standards:

- Follow general construction and safety regulations when working on electrical installations.
 - After the installation, the ground wire must be permanently connected to all electrical units according to the connection diagram.
 - Do not operate electrical equipment at any time if the ground wire is not permanently connected, even for brief measurements or tests.
 - Before working with electrical parts with voltage potentials higher than 50 V, the equipment must be disconnected from the mains voltage or power supply. Make sure the equipment is not switched back on.
 - Never touch the electrical connection points of a component while power is turned on.
 - Before turning on the equipment, shield live parts to prevent contact.
 - A residual-current-operated protective device must not be used on an AC drive! Indirect contact must be prevented by other means, for example, by an overcurrent protective device (in accordance with EN 501787/ 1994, section 5.3.2.3).
 - Equipment that is built into machines must be secured against direct contact. Use appropriate housings such as a control cabinet, for example (in accordance with EN 501787/ 1994).
-

Protection of Safety-Separated Extra Low Voltages

The connections and interfaces for signal voltages from 5 to 50 V are safety separated electrical circuits that have shock-hazard protection.



WARNING

High electrical voltage due to wrong connections

Risk of death or serious bodily injury.

⇒ Construction and design according to the following standards:

- Only equipment, electrical components or cabling that is sufficiently safety-separated from the connected power circuits in accordance with IEC 364-4-41, 413.5 or DIN EN 50178, 12.94, section 5.2.18 may be connected to the signal voltage connectors and interfaces of this equipment.

Protection Against Dangerous Movements

Dangerous movements can be caused by faulty control of the motors or other moving elements that are connected to this control.



DANGER

Malfunction in the control of motors and moving elements

Equipment damage can occur.

⇒ Construction and design according to the following standards:

The causes can be as follows:

- software errors
- defects in parts of the components
- wiring or cabling errors
- malfunction of measuring and signaling encoders
- inappropriate or incorrect operation of equipment

Dangerous movements can occur immediately after equipment is switched on or even after an unspecified period of trouble-free operation. The monitoring systems in this control make malfunctions in the connected drives very unlikely. For protection of personnel, however, one cannot depend solely on this functionality. Until the built-in monitoring systems become active and effective, it must always be assumed, in any case, that some faulty drive movements will occur. The extent of these faulty drive movements depends upon the type of fault and the operating state.

For the above reasons, personnel safety must be ensured by means of monitoring or measures implemented at the facility in which the drives are used. These monitoring systems or measures are planned by the machine builder in accordance with the specific conditions of the facility, following a risk and fault analysis. All the valid safety regulations that apply to the machine are taken into consideration.

The following is especially to be observed:

- Keep free and clear of the machine's range of motion.
- ⇒ Prevent personnel from accidentally entering the machine's range of motion: Use protective fences, protective screens, protective coverings and light barriers or light curtains.
- Fences and coverings must be strong enough to withstand maximum possible momentum.
- Mount the emergency stop switch (E-stop) within the immediate reach of the operator. Verify that the emergency stop works before startup.
- Isolate the drive power connection by means of an emergency stop circuit or use a start-inhibit system to prevent unintentional start-up.
- Make sure that the drives are brought to a standstill before accessing or entering the danger zone.
- Disconnect electrical power to the equipment using a master switch and provide safeguards to prevent unintentional restarts when:
 - performing maintenance and repair work
 - cleaning the equipment
 - long periods of discontinued equipment use are imminent

Protection During Handling and Installation

Avoid operating high-frequency and radio equipment near electronic circuits and supply leads. If use of such equipment cannot be avoided, the system and the facility in which it is installed should be checked for possible malfunctions at all possible positions of normal use before the first start-up. If necessary, perform a special electromagnetic compatibility (EMC) test on the facility.

Under unfavorable conditions, improper handling and installation of this equipment may cause injuries.



CAUTION

Error During Handling and Installation

Under unfavorable conditions, inappropriate handling and installation of this equipment may cause injuries (crushing, shearing, cutting and mechanical shock).

⇒ Preventive Measures:

- Observe general instructions and safety regulations regarding handling and installation.
- Use only appropriate lifting or moving equipment.
- Take precautions to avoid pinching and crushing.
- Use only appropriate tools. If specified by the product documentation, special tools must be used.
- Use lifting devices and tools correctly and safely.
- Wear appropriate protective gear, e.g. safety glasses, safety shoes and safety gloves.
- Never linger under suspended loads.
- Clean up liquids from the floor immediately to prevent the risk of slipping.

Protection for Built-In Batteries

Batteries contain reactive chemicals in a solid housing. Improper handling may, therefore, result in injuries or equipment damage.



CAUTION

Danger from batteries and capacitors

Bodily injury and equipment damage from explosion or contact with chemicals

⇒ Preventive Measures:

- Do not attempt to reactivate discharged batteries by heating or other methods (danger of explosion and release of corrosive substances).
 - Never charge batteries (danger from leakage and explosion).
 - Never throw batteries into a fire.
 - Do not dismantle batteries.
 - Do not damage electrical components installed in the equipment.
-

Note:

Environmental Protection and Disposal

In terms of the legal requirements, the batteries contained in the product must be considered a hazardous material for land, air and sea transport (danger of explosion).

- Dispose of batteries separately from other refuse.
 - Observe the national specifications of the country of installation.
-

14 Index

A

AND 6-2
ANDN 6-2
Appropriate use
 Introduction 2-1
 Uses 2-2
Assignment of Profibus Connector X30 10-7
Automatic Mode 7-1
Available Variables 5-8

B

Battery is low 1-3
Brake 9-9

C

Checksum 9-21
cycle time 8-32

D

Data formats 10-6
Decade Switch 5-26
Deceleration active 8-25
Diagnostic Channel 10-4
Drive Enable 9-8
Drive Runaway 8-17

E

Electrical Release 7-18
Enable Axis 8-27
External clear 9-5

F

Fault 9-8
Feed angle monitoring 8-18
Feed Constant 7-11
Functioning of Measuring Wheel Mode 7-2

G

Gear 8-7
 Feed Constant 7-11
 Gear Ratio 7-11

I

I/O Channel 10-2
I/O Control Word 10-3
I/O Status Word 10-3
Inappropriate use 2-2
 Consequences, Discharge of liability 2-1
Inhibit Operation 9-10
Input Unit 8-6
Inputs 9-2
Interrupt 8-18
Interrupt vector 7-7

J

Jerk 8-13
Jogging 9-6

K

Kv Factor 8-14

L

Language Selection 8-27
LD 6-1
LDN 6-1
Linear motion 8-5
Logic Task Marker Flags 9-12

M

Manual Mode 7-1
Manual vector program 7-6
marker flags 9-11
Master Encoder 8-41
measuring wheel encoder 8-5
Measuring Wheel Mode 7-1
Mechanical Transmission Elements 7-11
memory display 8-40
Modulo function 7-12
modulo value 8-10

N

NC Marker Flags 9-12

O

Operating Modes 7-1
OR 6-3
ORN 6-3
Outputs 9-7
Override 8-35

P

Parameter Mode 7-1
Pertinent Parameters for Measuring Wheel Mode 7-2
Position Lag 8-17
Position Loop Reset 7-18
Process Data Channel 10-2
Profibus 10-1
Profibus Connector X30 10-7
Profibus DP address 10-1
Profibus LED Diagnostic 10-7

R

Read Control Word 10-4
Read Status Word 10-4
RES 6-1
RESC 6-1
Restart 9-6
Rotary motion 8-5
Rotary table 8-5
RS commands 9-40
RS Logic Task 9-28
RS parameters 9-24
RS program instructions 9-24
RS Status actual velocity 9-37
RS Status analog input 9-38
RS Status Bytes M/I/Q 9-39
RS Status error message 9-39
RS status information 9-29
RS Status Software Version 9-33
RS status transmission error 9-30
RS status, current instruction number 9-31
RS variables 9-28
Run Task 9-10

S

Safety Inputs 9-3
Safety Instructions for Electric Drives and Controls 3-1
serial interface 9-13
Service Data Channel 10-6
SET 6-1
SETC 6-1
Signal Assignment for X30 Profibus Connector 10-7
Slave axis 8-5
ST 6-1
Start 9-5
STN 6-1
Store inhibited 8-27
Switching threshold 8-23
Synchronous axis 8-5
System Flags 9-12

T

Target velocity reached 8-25
Task 7-8
Transfer Flags 9-12
Travel limit value, maximum 8-9
Travel limit value, minimum 8-7
Type of motion 8-5

U

Use *See appropriate use and inappropriate use*

V

Variable Channel 10-4
Variable Datum 10-4
Variables 5-7
velocity 8-11

W

Write Control Word 10-4
Write Status Word 10-4

X

XOR 6-4
XORN 6-4

15 Service & Support

15.1 Helpdesk

Unser Kundendienst-Helpdesk im Hauptwerk Lohr am Main steht Ihnen mit Rat und Tat zur Seite. Sie erreichen uns

- telefonisch: **+49 (0) 9352 40 50 60**
über Service Call Entry Center Mo-Fr 07:00-18:00
- per Fax: **+49 (0) 9352 40 49 41**
- per e-Mail: **service@indramat.de**

Our service helpdesk at our headquarters in Lohr am Main, Germany can assist you in all kinds of inquiries. Contact us

- by phone: **+49 (0) 9352 40 50 60**
via Service Call Entry Center Mo-Fr 7:00 am - 6:00 pm
- by fax: **+49 (0) 9352 40 49 41**
- by e-mail: **service@indramat.de**

15.2 Service-Hotline

Außerhalb der Helpdesk-Zeiten ist der Service direkt ansprechbar unter

+49 (0) 171 333 88 26
oder **+49 (0) 172 660 04 06**

After helpdesk hours, contact our service department directly at

+49 (0) 171 333 88 26
or **+49 (0) 172 660 04 06**

15.3 Internet

Ergänzende Hinweise zu Service, Reparatur und Training sowie die **aktuellen** Adressen unserer Service- und Vertriebsbüros finden Sie unter **www.indramat.de** – einige Angaben in dieser Dokumentation können inzwischen überholt sein.

Außerhalb Deutschlands nehmen Sie bitte zuerst Kontakt mit Ihrem lokalen Ansprechpartner auf.

- Verkaufsniederlassungen
 Niederlassungen mit Kundendienst

Additional notes about service, repairs and training as well as the **actual** addresses of our sales- and service facilities are available on the Internet at **www.indramat.de** – some information in this documentation may meanwhile be obsolete.

Please contact the sales & service offices in your area first.

- sales agencies
 offices providing service

15.4 Vor der Kontaktaufnahme... - Before contacting us...

Wir können Ihnen schnell und effizient helfen wenn Sie folgende Informationen bereithalten:

1. detaillierte Beschreibung der Störung und der Umstände.
2. Angaben auf dem Typenschild der betreffenden Produkte, insbesondere Typenschlüssel und Seriennummern.
3. Tel./Faxnummern und e-Mail-Adresse, unter denen Sie für Rückfragen zu erreichen sind.

For quick and efficient help, please have the following information ready:

1. Detailed description of the failure and circumstances.
2. Information on the type plate of the affected products, especially type codes and serial numbers.
3. Your phone/fax numbers and e-mail address, so we can contact you in case of questions.

15.5 Kundenbetreuungsstellen - Sales & Service Facilities

Deutschland – Germany

vom Ausland:

(0) nach Landeskennziffer weglassen!

from abroad:

don't dial (0) after country code!

Vertriebsgebiet Mitte Germany Centre	SERVICE	SERVICE	SERVICE
<p>Rexroth Indramat GmbH Bgm.-Dr.-Nebel-Str. 2 97816 Lohr am Main</p> <p>Kompetenz-Zentrum Europa</p> <p>Tel.: +49 (0)9352 40-0 Fax: +49 (0)9352 40-4885</p>	<p>CALL ENTRY CENTER MO – FR von 07:00 - 18:00 Uhr from 7 am – 6 pm</p> <p>Tel. +49 (0) 9352 40 50 60 service@indramat.de</p>	<p>HOTLINE MO – FR von 17:00 - 07:00 Uhr from 5 pm - 7 am + SA / SO</p> <p>Tel.: +49 (0)172 660 04 06 oder / or Tel.: +49 (0)171 333 88 26</p>	<p>ERSATZTEILE / SPARES verlängerte Ansprechzeit - extended office time - ♦ nur an Werktagen - only on working days - ♦ von 07:00 - 18:00 Uhr - from 7 am - 6 pm - Tel. +49 (0) 9352 40 42 22</p>
<p>Vertriebsgebiet Süd Germany South</p> <p>Rexroth Indramat GmbH Landshuter Allee 8-10 80637 München Tel.: +49 (0)89 127 14-0 Fax: +49 (0)89 127 14-490</p>	<p>Gebiet Südwest Germany South-West</p> <p>Bosch Rexroth AG Vertrieb Deutschland – VD-BI Geschäftsbereich Rexroth Indramat Regionalzentrum Südwest Ringstrasse 70 / Postfach 1144 70736 Fellbach / 70701 Fellbach</p> <p>Tel.: +49 (0)711 57 61-100 Fax: +49 (0)711 57 61-125</p>	<p>Vertriebsgebiet Ost Germany East</p> <p>Bosch Rexroth AG Beckerstraße 31 09120 Chemnitz</p> <p>Tel.: +49 (0)371 35 55-0 Fax: +49 (0)371 35 55-333</p>	<p>Vertriebsgebiet Ost Germany East</p> <p>Bosch Rexroth AG Regionalzentrum Ost Walter-Köhn-Str. 4d 04356 Leipzig</p> <p>Tel.: +49 (0)341 25 61-0 Fax: +49 (0)341 25 61-111</p>
<p>Vertriebsgebiet West Germany West</p> <p>Bosch Rexroth AG Vertrieb Deutschland Regionalzentrum West Borsigstrasse 15 40880 Ratingen</p> <p>Tel.: +49 (0)2102 409-0 Fax: +49 (0)2102 409-406</p>	<p>Vertriebsgebiet Mitte Germany Centre</p> <p>Bosch Rexroth AG Regionalzentrum Mitte Waldecker Straße 13 64546 Mörfelden-Walldorf</p> <p>Tel.: +49 (0) 61 05 702-3 Fax: +49 (0) 61 05 702-444</p>	<p>Vertriebsgebiet Nord Germany North</p> <p>Bosch Rexroth AG Walsroder Str. 93 30853 Langenhagen</p> <p>Tel.: +49 (0) 511 72 66 57-0 Fax: +49 (0) 511 72 66 57-95</p>	<p>Vertriebsgebiet Nord Germany North</p> <p>Bosch Rexroth AG Kieler Straße 212 22525 Hamburg</p> <p>Tel.: +49 (0) 40 81 955 966 Fax: +49 (0) 40 85 418 978</p>

Europa (West) - Europe (West)

vom Ausland: (0) nach Landeskenziffer weglassen, **Italien:** 0 nach Landeskenziffer mitwählen
from abroad: don't dial (0) after country code, **Italy:** dial 0 after country code

<p>Austria - Österreich</p> <p>Bosch Rexroth GmbH Bereich Indramat Stachegasse 13 1120 Wien</p> <p>Tel.: +43 (0)1 985 25 40 Fax: +43 (0)1 985 25 40-93</p>	<p>Austria – Österreich</p> <p>Bosch Rexroth G.m.b.H. Gesch.ber. Rexroth Indramat Industriepark 18 4061 Pasching</p> <p>Tel.: +43 (0)7221 605-0 Fax: +43 (0)7221 605-21</p>	<p>Belgium - Belgien</p> <p>Bosch Rexroth AG Electric Drives & Controls Industrielaan 8 1740 Ternat</p> <p>Tel.: +32 (0)2 5830719 Service: +32 (0)2 5830717 Fax: +32 (0)2 5830731 indramat@boschrexroth.be</p>	<p>Denmark - Dänemark</p> <p>Bosch Rexroth A/S Zinkvej 6 8900 Randers</p> <p>Tel.: +45 (0)87 11 90 60 Fax: +45 (0)87 11 90 61</p>
<p>Great Britain – Großbritannien</p> <p>Bosch Rexroth Ltd. Rexroth Indramat Division Broadway Lane, South Cerney Cirencester, Glos GL7 5UH</p> <p>Tel.: +44 (0)1285 863000 Fax: +44 (0)1285 863030 sales@indramat.co.uk service@indramat.co.uk</p>	<p>Finland - Finnland</p> <p>Rexroth Mecman Oy Rexroth Indramat division Ansatie 6 017 40 Vantaa</p> <p>Tel.: +358 (0)9 84 91-11 Fax: +358 (0)9 84 91-13 60</p>	<p>France - Frankreich</p> <p>Bosch Rexroth S.A. Division Rexroth Indramat Avenue de la Trentaine BP. 74 77503 CHELLES CEDEX</p> <p>Tel.: +33 (0)164 72-70 00 Fax: +33 (0)164 72-63 00 Hotline: +33 (0)608 33 43 28</p>	<p>France - Frankreich</p> <p>Bosch Rexroth S.A. Division Rexroth Indramat 1270, Avenue de Lardenne 31100 Toulouse</p> <p>Tel.: +33 (0)5 61 49 95 19 Fax: +33 (0)5 61 31 00 41</p>
<p>France - Frankreich</p> <p>Bosch Rexroth S.A. Division Rexroth Indramat 91, Bd. Irène Joliot-Curie 69634 Vénissieux – Cedex</p> <p>Tel.: +33 (0)4 78 78 53 65 Fax: +33 (0)4 78 78 53 62</p>	<p>Italy - Italien</p> <p>Bosch Rexroth S.p.A. Via G. Di Vittoria, 1 20063 Cernusco S/N.MI</p> <p>Tel.: +39 02 2 365 270 Fax: +39 02 700 408 252378</p>	<p>Italy - Italien</p> <p>Bosch Rexroth S.p.A. Via Paolo Veronesi, 250 10148 Torino</p> <p>Tel.: +39 011 224 88 11 Fax: +39 011 220 48 04</p>	<p>Italy - Italien</p> <p>Bosch Rexroth S.p.A. Via del Progresso, 16 (Zona Ind.) 35020 Padova</p> <p>Tel.: +39 049 8 70 13 70 Fax: +39 049 8 70 13 77</p>
<p>Italy - Italien</p> <p>Bosch Rexroth S.p.A. Via Mascia, 1 80053 Castellammare di Stabia NA</p> <p>Tel.: +39 081 8 71 57 00 Fax: +39 081 8 71 68 85</p>	<p>Italy - Italien</p> <p>Bosch Rexroth S.p.A. Viale Oriani, 38/A 40137 Bologna</p> <p>Tel.: +39 051 34 14 14 Fax: +39 051 34 14 22</p>	<p>Netherlands - Niederlande/Holland</p> <p>Bosch Rexroth B.V. Kruisbroeksestraat 1 (P.O. Box 32) 5281 RV Boxtel</p> <p>Tel.: +31 (0)411 65 19 51 Fax: +31 (0)411 65 14 83 indramat@hydraudyne.nl</p>	<p>Netherlands - Niederlande/Holland</p> <p>Bosch Rexroth Services B.V. Kruisbroeksestraat 1 (P.O. Box 32) 5281 RV Boxtel</p> <p>Tel.: +31 (0)411 65 19 51 Fax: +31 (0)411 67 78 14</p>
<p>Norway - Norwegen</p> <p>Bosch Rexroth AS Rexroth Indramat Division Berghagan 1 or: Box 3007 1405 Ski-Langhus 1402 Ski</p> <p>Tel.: +47 (0)64 86 41 00 Fax: +47 (0)64 86 90 62 jul.ruud@rexroth.no</p>	<p>Spain - Spanien</p> <p>Bosch Rexroth S.A. División Rexroth Indramat Centro Industrial Santiga Obradors s/n 08130 Santa Perpetua de Mogoda Barcelona</p> <p>Tel.: +34 9 37 47 94 00 Fax: +34 9 37 47 94 01</p>	<p>Spain - Spanien</p> <p>Goimendi S.A. División Rexroth Indramat Parque Empresarial Zuatzu C/ Francisco Grandmontagne no.2 20018 San Sebastian</p> <p>Tel.: +34 9 43 31 84 21 - service: +34 9 43 31 84 56 Fax: +34 9 43 31 84 27 - service: +34 9 43 31 84 60 satindramat-goimendi@adegi.es</p>	<p>Sweden - Schweden</p> <p>Rexroth Mecman Svenska AB Rexroth Indramat Division Varuvägen 7 125 81 Stockholm</p> <p>Tel.: +46 (0)8 727 92 00 Fax: +46 (0)8 647 32 77</p>
<p>Sweden - Schweden</p> <p>Rexroth Mecman Svenska AB Indramat Support Ekvändan 7 254 67 Helsingborg</p> <p>Tel.: +46 (0) 42 38 88 -50 Fax: +46 (0) 42 38 88 -74</p>	<p>Switzerland West - Schweiz West</p> <p>Bosch Rexroth Suisse SA Département Rexroth Indramat Rue du village 1 1020 Renens</p> <p>Tel.: +41 (0)21 632 84 20 Fax: +41 (0)21 632 84 21</p>	<p>Switzerland East - Schweiz Ost</p> <p>Bosch Rexroth Schweiz AG Geschäftsbereich Indramat Hemrietstrasse 2 8863 Buttikon</p> <p>Tel. +41 (0) 55 46 46 205 Fax +41 (0) 55 46 46 222</p>	

Europa (Ost) - Europe (East)

vom Ausland: (0) nach Landeskennziffer weglassen
from abroad: don't dial (0) after country code

Czech Republic - Tschechien Bosch -Rexroth, spol.s.r.o. Hviezdoslavova 5 627 00 Brno Tel.: +420 (0)5 48 126 358 Fax: +420 (0)5 48 126 112	Czech Republic - Tschechien DEL a.s. Strojirenská 38 Zdar nad Sázavou 591 01 Czech republic Tel.: +420 616 64 3144 Fax: +420 616 216 57	Hungary - Ungarn Bosch Rexroth Kft. Angol utca 34 1149 Budapest Tel.: +36 (1) 364 00 02 Fax: +36 (1) 383 19 80	Poland – Polen Bosch Rexroth Sp.zo.o. Biuro Poznan ul. Dabrowskiego 81/85 60-529 Poznan Tel.: +48 061 847 64 62 /-63 Fax: +48 061 847 64 02
Rumania - Rumänien Bosch Rexroth Sp.zo.o. Str. Drobety nr. 4-10, app. 14 70258 Bucuresti, Sector 2 Tel.: +40 (0)1 210 48 25 +40 (0)1 210 29 50 Fax: +40 (0)1 210 29 52	Russia - Russland Bosch Rexroth Wolokolamskoje Chaussee 73 Zimmer 406, 408 RUS – 123424 Moskau Tel.: +7 095/ 232 08 34 +7 095/ 232 08 35 Fax: +7 095/ 232 08 36 info.rex@rexroth.ru	Russia - Russland ELMIS 10, Internationalnaya Str. 246640 Gomel, Belarus Tel.: +375/ 232 53 42 70 Fax: +375/ 232 53 37 69 elmis_ltd@yahoo.com	Turkey - Türkei Bosch Rexroth Otomasyon San & Tic. A.S. Fevzi Cakmak Cad No. 3 34630 Sefaköy Istanbul Tel.: +90 212 541 60 70 Fax: +90 212 599 34 07
Slowenia - Slowenien DOMEI Otoki 21 64 228 Zelezniki Tel.: +386 5 5117 152 Fax: +386 5 5117 225 brane.ozebek@domel.si			

Africa, Asia, Australia – incl. Pacific Rim

vom Ausland: (0) nach Landeskennziffer weglassen!
from abroad: don't dial (0) after country code!

<p>Australia - Australien</p> <p>AIMS - Australian Industrial Machinery Services Pty. Ltd. Unit 3/45 Horne ST Campbellfield , VIC 3061 Melbourne</p> <p>Tel.: +61 (0) 393 590 228 Fax: +61 (0) 393 590 286 Hotline: +61 (0) 419 369 195 terryobrien@aimservices.com.au</p>	<p>Australia - Australien</p> <p>Bosch Rexroth Pty. Ltd. No. 7, Endeavour Way Braeside Victoria, 31 95 Melbourne</p> <p>Tel.: +61 (0)3 95 80 39 33 Fax: +61 (0)3 95 80 17 33 mel@rexroth.com.au</p>	<p>China</p> <p>Bosch Rexroth Ltd. Wai Gaoqiao Free Trade Zone No.122, Fu Te Dong Yi Road Shanghai 200131 - P.R.China</p> <p>Tel.: +86 21 58 66 30 30 Fax: +86 21 58 66 55 23 roger.shi_sh@boschrexroth.com.cn</p>	<p>China</p> <p>Bosch Rexroth (China) Ltd. 15/F China World Trade Center 1, Jianguomenwai Avenue Beijing 100004, P.R.China</p> <p>Tel.: +86 10 65 05 03 80 Fax: +86 10 65 05 03 79</p>
<p>China</p> <p>Bosch Rexroth (China) Ltd. A-5F., 123 Lian Shan Street Sha He Kou District Dalian 116 023, P.R.China</p> <p>Tel.: +86 411 46 78 930 Fax: +86 411 46 78 932</p>	<p>China</p> <p>Bosch Rexroth (Changzhou) Co.Ltd. Guangzhou Repres. Office Room 1014-1016, Metro Plaza, Tian He District, 183 Tian He Bei Rd Guangzhou 510075, P.R.China</p> <p>Tel.: +86 20 8755-0030 +86 20 8755-0011 Fax: +86 20 8755-2387</p>	<p>Hongkong</p> <p>Bosch Rexroth (China) Ltd. 6th Floor, Yeung Yiu Chung No.6 Ind Bldg. 19 Cheung Shun Street Cheung Sha Wan, Kowloon, Hongkong</p> <p>Tel.: +852 22 62 51 00 Fax: +852 27 41 33 44 alexis.siu@boschrexroth.com.hk</p>	<p>India - Indien</p> <p>Bosch Rexroth (India) Ltd. Rexroth Indramat Division Plot. A-58, TTC Industrial Area Thane Turbhe Midc Road Mahape Village Navi Mumbai - 400 701</p> <p>Tel.: +91 (0)22 7 61 46 22 Fax: +91 (0)22 7 68 15 31</p>
<p>India - Indien</p> <p>Bosch Rexroth (India) Ltd. Rexroth Indramat Division Plot. 96, Phase III Peenya Industrial Area Bangalore - 560058</p> <p>Tel.: +91 (0)80 8 39 73 74 Fax: +91 (0)80 8 39 43 45</p>	<p>Indonesia - Indonesien</p> <p>PT. Rexroth Wijayakusuma Building # 202, Cilandak Commercial Estate Jl. Cilandak KKO, Jakarta 12560</p> <p>Tel.: +62 21 7891169 (5 lines) Fax: +62 21 7891170 - 71</p>	<p>Japan</p> <p>Bosch Rexroth Automation Corp. Service Center Japan Yutakagaoka 1810, Meito-ku, NAGOYA 465-0035, Japan</p> <p>Tel.: +81 (0)52 777 88 41 +81 (0)52 777 88 53 +81 (0)52 777 88 79 Fax: +81 (0)52 777 89 01</p>	<p>Japan</p> <p>Bosch Rexroth Automation Corp. Rexroth Indramat Division 1F, I.R. Building Nakamachidai 4-26-44, Tsuzuki-ku YOKOHAMA 224-0041, Japan</p> <p>Tel.: +81 (0)45 942 72 10 Fax: +81 (0)45 942 03 41</p>
<p>Korea</p> <p>Bosch Rexroth-Korea Ltd. 1515-14 Dadae-Dong, Saha-Ku Rexroth Indramat Division Pusan Metropolitan City, 604-050 Republic of South Korea</p> <p>Tel.: +82 (0)51 26 00 741 Fax: +82 (0)51 26 00 747 gyhan@rexrothkorea.co.kr</p>	<p>Malaysia</p> <p>Bosch Rexroth Sdn.Bhd. Head Office No. 3, Block B, Jalan SS 13/5 Subang Jaya Industrial Estate 47500 Petaling Jaya - Selangor</p> <p>Tel.: +60 (0) 3 73 44 870 Fax: +60 (0) 3 73 44 864 hockhwa@hotmail.com</p>	<p>Singapore - Singapur</p> <p>Robert Bosch (SEA) Pte Ltd. Dept. RBSI-R/SAT 38-C Jalan Pemimpin Singapore 577180</p> <p>Tel.: +65 35 05 470 Fax: +65 35 05 313 kenton.peh@sg.bosch.com</p>	<p>South Africa - Südafrika</p> <p>TECTRA Automation (Pty) Ltd. 28 Banfield Road, Industria North RSA - Maraisburg 1700</p> <p>Tel.: +27 (0)11 673 20 80 Fax: +27 (0)11 673 72 69 Hotline: +27 (0)82 903 29 23 georgv@tectra.co.za</p>
<p>Taiwan</p> <p>Rexroth Uchida Co., Ltd. No.17, Lane 136, Cheng Bei 1 Rd., Yungkuang, Tainan Hsien Taiwan, R.O.C.</p> <p>Tel.: +886 (0)6 25 36 565 Fax: +886 (0)6 25 34 754 indramat@mail.net.tw</p>	<p>Thailand</p> <p>NC Advance Technology Co. Ltd. 59/76 Moo 9 Ramintra road 34 Tharang, Bangkhen, Bangkok 10230</p> <p>Tel.: +66 2 943 70 62 +66 2 943 71 21 Fax: +66 2 509 23 62 sonkawin@hotmail.com</p>		

Nordamerika – North America

USA Hauptniederlassung - Headquarters Bosch Rexroth Corporation Rexroth Indramat Division 5150 Prairie Stone Parkway Hoffman Estates, IL 60192-3707 Tel.: +1 847 6 45 36 00 Fax: +1 847 6 45 62 01 service@indramat.com	USA Central Region - Mitte Bosch Rexroth Corporation Rexroth Indramat Division Central Region Technical Center Auburn Hills, MI 48326 Tel.: +1 248 3 93 33 30 Fax: +1 248 3 93 29 06	USA Southeast Region - Südwest Bosch Rexroth Corporation Rexroth Indramat Division Southeastern Technical Center 3625 Swiftwater Park Drive Suwanee, Georgia 30174 Tel.: +1 770 9 32 32 00 Fax: +1 770 9 32 19 03	USA SERVICE-HOTLINE - 7 days x 24hrs - +1-800-860-1055
USA East Region –Ost Bosch Rexroth Corporation Rexroth Indramat Division Charlotte Regional Sales Office 14001 South Lakes Drive Charlotte, North Carolina 28273 Tel.: +1 704 5 83 97 62 +1 704 5 83 14 86	USA Northeast Region – Nordost Bosch Rexroth Corporation Rexroth Indramat Division Northeastern Technical Center 99 Rainbow Road East Granby, Connecticut 06026 Tel.: +1 860 8 44 83 77 Fax: +1 860 8 44 85 95	USA West Region – West Bosch Rexroth Corporation 7901 Stoneridge Drive, Suite 220 Pleasant Hill, California 94588 Tel.: +1 925 227 10 84 Fax: +1 925 227 10 81	
Canada East - Kanada Ost Bosch Rexroth Canada Corporation Burlington Division 3426 Mainway Drive Burlington, Ontario Canada L7M 1A8 Tel.: +1 905 335 55 11 Fax: +1 905 335-41 84 michael.moro@boschrexroth.ca	Canada West - Kanada West Bosch Rexroth Canada Corporation 5345 Goring St. Burnaby, British Columbia Canada V7J 1R1 Tel. +1 604 205-5777 Fax +1 604 205-6944 david.gunby@boschrexroth.ca		

Südamerika – South America

Argentina - Argentinien Bosch Rexroth S.A.I.C. "The Drive & Control Company" Acaassuso 48 41/47 1605 Munro Prov. Buenos Aires Tel.: +54 (0)11 4756 01 40 Fax: +54 (0)11 4756 01 36 mannesmann@mannesmannsaic.com.ar	Argentina - Argentinien NAKASE Servicio Tecnico CNC Calle 49, No. 5764/66 1653 Villa Balester Prov. - Buenos Aires Tel.: +54 (0) 11 4768 36 43 Fax: +54 (0) 11 4768 24 13 nakase@usa.net nakase.com	Brazil - Brasilien Bosch Rexroth Ltda. Av. Tégula, 888 Ponte Alta, Atibaia SP CEP 12942-440 Tel.: +55 (0)11 4414 56 92 +55 (0)11 4414 56 84 Fax sales: +55 (0)11 4414 57 07 Fax serv.: +55 (0)11 4414 56 86 alexandre.wittwer@rexroth.com.br	Brazil - Brasilien Bosch Rexroth Ltda. R. Dr.Humberto Pinheiro Vieira, 100 Distrito Industrial [Caixa Postal 1273] BR - 89220-390 Joinville - SC Tel./Fax: +55 (0)47 473 58 33 Mobil: +55 (0)47 9974 6645 prochnow@zaz.com.br
Mexico Bosch Rexroth S.A. de C.V. Calle Neptuno 72 Unidad Ind. Vallejo MEX - 07700 Mexico, D.F. Tel.: +52 5 754 17 11 +52 5 754 36 84 +52 5 754 12 60 Fax: +52 5 754 50 73 +52 5 752 59 43	Columbia - Kolumbien Reflutec de Colombia Ltda. Calle 37 No. 22-31 Santafé de Bogotá, D.C. Colombia Tel.: +57 1 368 82 67 +57 1 368 02 59 Fax: +57 1 268 97 37 reflutec@inter.net.co		

Barcode

Printed in the U.S.A.

